



TRADOC Pamphlet 600-4  
23 December 2008

# IET

## SOLDIER'S HANDBOOK

HEADQUARTERS  
DEPARTMENT OF THE ARMY  
United States Army Training and Doctrine Command  
Fort Monroe, Virginia 23651-5000

---



23 December 2008

Personnel - General

INITIAL ENTRY TRAINING SOLDIER'S HANDBOOK

---

FOR THE COMMANDER:

OFFICIAL:

DAVID P. VALCOURT  
Lieutenant General, U.S. Army  
Deputy Commanding General/  
Chief of Staff



RANDALL L. MACKEY  
Colonel, GS  
Deputy Chief of Staff, G-6

**History.** This pamphlet is a rapid action revision. The portions affected by this rapid action revision are listed in the summary of change.

**Summary.** This pamphlet updates information that is intended for the professional development of all initial entry **Soldiers**.

**Applicability.** This pamphlet is intended as a pocket reference for all initial entry Soldiers and Reserve Officer Training Corps Cadets. You will need expertise in its many subject areas to conduct yourself professionally through IET and beyond

**Proponent and exception authority.** The proponent of this pamphlet is the Deputy Chief of Staff, G-3/5/7. The proponent has the authority to approve exceptions or waivers to this pamphlet that are consistent with controlling law and regulations. The proponent may delegate this approval authority in writing, to a division chief with the proponent agency or its direct reporting unit or field-operating agency, in the grade of colonel or the civilian equivalent. Activities may request a waiver to this pamphlet by providing justification that includes a full analysis of the expected benefits and must include formal review by the activity's senior legal officer. All waiver requests will be endorsed by the commander or senior leader of the

\*This pamphlet supersedes TRADOC Pamphlet 600-4, dated 4 September 2007.

requesting activity and forwarded through higher headquarters to the policy proponents. provisions.

**Suggested improvements.** Users send comments and suggested improvements on Department of the Army (DA) Form 2028 (Recommended Changes to Publications and Blank Forms) directly to Deputy Chief of Staff, G-3/5/7 (ATTG-TRI-II), 5 Fenwick Road, Fort Monroe, VA 23651-1047.

**Distribution.** This publication is available only on the TRADOC Homepage at <http://www.tradoc.army.mil>.

---

### Summary of Change

TRADOC Pam 600-4

Initial Entry Training Soldier's Handbook

This rapid action revision, dated 23 December 2008.

- Updates Army Values poster (para 2-6).
- Updates picture of Medal of Honor winner SFC Paul R. Smith (para 2-6).
- Adds outcomes based training (para 2-8).
- Adds Soldier's Prayer (para 2-9).
- Adds ethical decisionmaking (para 3-18).
- Removes the individual supported fighting position (para 5-2).
- Adds basic firing positions; prone supported, prone unsupported and kneeling position (para 5-2).
- Adds weapons status (para 5-5).
- Adds weapons clearing (para 5-6).
- Removes M9 pistol (para 6-5).
- Removes MK 19 machine gun (para 6-10).
- Updates combative principles (para 7-1).
- Adds dominant fighting positions pictures (para 7-2).
- Removed vital targets (figures 7-1 and 7-2).
- Removed vital targets and strike effects (tables 7-1 and 7-2).
- Adds key to defeating improvised explosive device threats (para 8-9).
- Adds identifying improvised explosive devices (para 8-10).
- Updates composite risk management (chapter 9).

TRADOC Pam 600-4

Rapid action revision, dated 4 September 2007.

- Adds to Army history (para 1-1).
- Adds interacting with media (para 1-19).
- Updates grade abbreviations (table 1-4).
- Updates customs and courtesies, saluting, cell phones, (para 1-8).
- Updates rendering honor to the flag, added “The flag when flown at half-staff (para 1-18(2)g).
- Adds My Army Benefits website (para 1-16).
- Updates promotions (para 1-16(3)).
- Adds stored value card (para 1-17(5)).
- Adds stored value card picture (figure 1-6).
- Updates Medal of Honor winner, SFC Paul R. Smith (para 2-6(7)).
- Adds Article 107 (para 3-4(7)).
- Updates drill formations (without weapons) picture (fig 4-1).
- Adds and clarifies E-4 grade collar and shoulder marks (fig 4-6).
- Replaces maintain your nutrition with fueling the body for optimal performance (para 4-6(11)).

**Contents**

	Page
Chapter 1 General Subjects .....	1
1-1. Army history .....	1
1-2. Army heritage and tradition .....	2
1-3. Army organization .....	5
1-4. Chain of command .....	6
1-5. Noncommissioned officer (NCO) support channel .....	7
1-6. Grade insignia .....	7
1-7. Military time.....	10
1-8. Customs and courtesies .....	12
1-9. Role of the chaplain.....	16
1-10. Military quotations .....	17
1-11. Declaration of Independence (extract) .....	18
1-12. Preamble to the Constitution of the United States.....	19
1-13. The Star-Spangled Banner - The National Anthem.....	20
1-14. Pledge of Allegiance .....	20
1-15. Soldier and family benefits .....	21
1-16. Promotions .....	25
1-17. Managing personal finances.....	26
1-18. Leave and earning statement (LES) .....	28
1-19. Public affairs - Interacting with media .....	29
Chapter 2 Army Values .....	32
2-1. Oath of Enlistment .....	32
2-2. Soldier's Creed.....	32
2-3. Soldier's Code.....	32
2-4. Soldier's responsibilities .....	32
2-5. Warrior Ethos .....	33
2-6. Army Values .....	34
2-7. Code of Conduct .....	50
2-8. Outcomes based training .....	50
Chapter 3 Standards of Conduct .....	53
3-1. The Uniform Code of Military Justice (UCMJ) .....	53
3-2. UCMJ: non-judicial punishment .....	54
3-3. UCMJ: courts-martial.....	55
3-4. UCMJ: punitive articles .....	56
3-5. UCMJ: forms of punishment.....	58
3-6. Army Equal Opportunity (EO) Program and policy .....	60
3-7. Military Whistleblowers Protection Act (MWPA).....	61
3-8. Army policy on relationships between Soldiers .....	61
3-9. Army Sexual Harassment Policy.....	63
3-10. Appropriate behavior.....	65
3-11. Alcohol and drug abuse.....	65
3-12. Consideration of others .....	66
3-13. Homosexual conduct policy .....	66
3-14. Dignity and respect.....	67

TRADOC Pam 600-4

3-15. Rape and sexual assault prevention .....	68
3-16. Soldier stress and a resilient attitude: You can make it.....	69
3-17. Suicide prevention .....	71
3-18. Ethical decisionmaking.....	72
3-19. Awards and decorations of the U.S. Army .....	74
3-20. Terrorism .....	76
Chapter 4 Basic Soldier Skills.....	78
4-1. The buddy system .....	78
4-2. Drill and ceremonies.....	78
4-3. Inspections .....	80
4-4. Personal appearance and uniform .....	80
4-5. Uniform wear and maintenance .....	82
4-6. Personal hygiene.....	87
4-7. Field sanitation and preventive medicine fieldcraft .....	92
4-8. Guard duty: general and special orders.....	115
4-9. Guard duty: interior and exterior .....	117
4-10. Guard duty: reacting to an inspecting officer.....	117
4-11. Guard duty: challenging unknown persons (night) and summoning the commander of the relief.....	118
Chapter 5 Rifle Marksmanship.....	120
5-1. Rifle marksmanship: fundamentals.....	120
5-2. Rifle marksmanship: firing positions combat applicable training course (CATC).....	125
5-3. Rifle marksmanship: positions of the coach .....	127
5-4. Rifle marksmanship: checklist for the coach .....	128
5-5. Weapons status .....	129
5-6. Weapons clearing.....	130
Chapter 6 U.S. Weapons .....	132
6-1. M16-series rifles and M4 series carbines description .....	132
6-2. M203 grenade launcher.....	144
6-3. M249 machine gun .....	148
6-4. M136 AT-4 antitank weapon .....	152
6-5. Hand grenades.....	156
6-6. M18A1 claymore mine .....	165
6-7. M240-B machine gun .....	170
6-8. Caliber .50 M2 machine gun.....	177
Chapter 7 Modern Army Combatives .....	184
7-1. Modern Army combatives principles.....	184
7-2. Modern Army combatives: dominant body positions .....	185
7-3. Modern Army combatives: rifle with fixed bayonet.....	189
Chapter 8 Tactics.....	196
8-1. Fire team formations.....	196
8-2. Serve as a member of a team .....	197
8-3. Squad formations .....	198
8-4. Fire team/squad movement techniques .....	200
8-5. Fighting positions .....	203
8-6. Cover, concealment, and camouflage .....	209

8-7. Chemical, biological, radiological, nuclear, (CBRN) - standard mission oriented protective posture (MOPP).....	216
8-8. Tactical foot marches and foot care .....	219
8-9. Key to defeating an improvised explosive device (IED).....	226
8-10. Key to identifying an IED .....	227
Chapter 9 Composite Risk Management (CMR).....	229
9-1. Principles of CRM and accident prevention.....	229
9-2. CRM tracking and documentation .....	234
9-3. CRM and the individual Soldier.....	235
Appendixes	
A. References.....	237
B. Soldier's notes.....	239
Glossary.....	258

### Table List

Table 1-1. The Army Song.....	3
Table 1-2. Active U.S. Army divisions .....	6
Table 1-3. My chain of command.....	7
Table 1-4. MY NCO SUPPORT CHANNEL .....	7
Table 1-5. Grade abbreviations.....	10
Table 1-6. Civilian/military time conversion chart.....	11
Table 1-7. Military quotations .....	17
Table 6-1. Accessory weapon system matrix .....	142
Table 6-2. Characteristics of the M16-/M4-series weapons .....	142
Table 6-3. Characteristics of various accessories for the M16-/M-4.....	143
Table 6-4. M203/M203A1 grenade launcher technical data.....	146
Table 6-5. M249 AR technical data.....	150
Table 6-6. M136 AT-4 technical data.....	155
Table 6-7. M67 fragmentation hand grenade.....	158
Table 6-8. M18 colored smoke hand grenade.....	159
Table 6-9. AN-M83 HC white smoke hand grenade .....	160
Table 6-10. ABC-M7A2 and ABC-M73A riot control hand grenades....	161
Table 6-11. AN-M14 TH3 incendiary hand grenade.....	162
Table 6-12. MK3A2 offensive (concussion) hand grenade .....	163
Table 6-13. M69 practice hand grenade .....	164
Table 6-14. M84 flash-bang stun hand grenade.....	165
Table 6-15. M240B machine gun technical data .....	172
Table 6-16. M240B ammunition and usage.....	177
Table 6-17. .50 M2 machine gun technical data.....	181
Table 8-1. Fire team formation characteristics .....	196
Table 8-2. Squad formation characteristics .....	200
Table 8-3. Movement techniques characteristics.....	201
Table 8-4. Camouflaging skin .....	216
Table 8-5. Availability and wear of MOPP equipment .....	218
Table 8-6. Key to defeating an IED.....	226
Table 8-7. Identifying an IED.....	227



**Figure List**

Figure 1-1. General Washington crossing the Delaware River .....5  
 Figure 1-2. Officer insignia.....8  
 Figure 1-3. Warrant officer insignia.....9  
 Figure 1-4. Enlisted insignia .....9  
 Figure 1-5. Military/civilian clock .....11  
 Figure 1-6. Hand salute with visor .....13  
 Figure 1-7. Hand salute with beret or uncovered .....14  
 Figure 1-8. Hand salute with beret and wearing glasses .....14  
 Figure 1-9. Eaglecash Stored Value Card .....27  
 Figure 4-1. Drill formations (without weapons).....79  
 Figure 4-2. Beret, male and female .....82  
 Figure 4-3. Shoulder sleeve insignia of current unit .....83  
 Figure 4-4. Distinguishing insignia .....84  
 Figure 4-5. Grade insignia.....84  
 Figure 4-6. Grade insignia, enlisted .....85  
 Figure 4-7. U.S. and branch insignia, enlisted male.....86  
 Figure 4-8. U.S. and branch insignia, enlisted female.....87  
 Figure 4-9. Trimming of toenails .....90  
 Figure 5-1. Steady position elements .....121  
 Figure 5-2. Correct sight picture .....122  
 Figure 5-3. Prone unsupported showing correct sight alignment .....123  
 Figure 5-4. Breath control .....124  
 Figure 5-5. Trigger squeeze .....124  
 Figure 5-6. Prone unsupported position .....126  
 Figure 5-7. Kneeling firing position.....126  
 Figure 5-8. Seated firing position.....127  
 Figure 5-9. Prone position of coach (right-handed firer).....128  
 Figure 5-10. Weapons status .....129  
 Figure 5-11. Weapons clearing .....130  
 Figure 6-1. M16- and M4-series weapon systems.....133  
 Figure 6-2. M16A2 and M16A3 major assemblies .....134  
 Figure 6-3. M16A4 and M4/M4A1 major assemblies .....135  
 Figure 6-4. Major assemblies for the M16- and M4-series weapons (right and left views) .....137  
 Figure 6-5. M16 and M4 series weapon system general accessories .....138  
 Figure 6-6. M16 and M4-series weapon system optical accessories .....140  
 Figure 6-7. Approved ammunition.....143  
 Figure 6-8. M4 carbine with M203A1 (left side view) .....144  
 Figure 6-9. M4 carbine with rail system .....144  
 Figure 6-10. Major assemblies of the M203 grenade launcher .....144  
 Figure 6-11. Cartridges for the M203 grenade launcher .....147  
 Figure 6-12. M249 automatic rifle .....148  
 Figure 6-13. M249 AR major assemblies .....149  
 Figure 6-14. Cartridges for the M249 AR.....151  
 Figure 6-15. M136 AT-4 antitank weapon major assemblies .....153  
 Figure 6-16. Effects of M136 AT4 warhead .....155

Figure 6-17. Hand grenade components and fuze functioning .....	156
Figure 6-18. M213, M228, and M201A1 Fuzes (left to right).....	157
Figure 6-19. M67 Fragmentation hand grenade .....	158
Figure 6-20. M18 Colored smoke hand grenade .....	158
Figure 6-21. AN-M83 HC White smoke hand grenade.....	159
Figure 6-22. ABC-M7A2 and ABC-M7A3 Riot-control hand grenades.	160
Figure 6-23. AN-M14 TH3 Incendiary hand grenade .....	161
Figure 6-24. MK3A2 Offensive (concussion) hand grenade.....	162
Figure 6-25. M69 practice hand grenade.....	163
Figure 6-26. M84 flash-bang stun hand grenade .....	164
Figure 6-27. M18A1 antipersonnel mine (claymore) components .....	166
Figure 6-28. M18A1 antipersonnel mine and accessories packed in the M7 bandoleer .....	166
Figure 6-29. Danger radius and effects of M18A1 .....	167
Figure 6-30. Arming and testing the M18A1 claymore mine.....	169
Figure 6-31. M240B machine gun.....	171
Figure 6-32. M240B, M122A1 tripod assembly, ammunition adapter, and M24 blank firing attachment .....	176
Figure 6-33. M240B machine gun ammunition and metallic belt .....	177
Figure 6-34. Caliber .50 machine gun, M2 mounts .....	179
Figure 6-35. Caliber .50 machine gun, M2, heavy barrel, M48 flexible type .....	180
Figure 6-36. Caliber .50 machine gun, M2, heavy barrel, M48 turret type .....	180
Figure 6-37. Authorized .50 M2 machine gun ammunition .....	182
Figure 7-1. Back mount.....	185
Figure 7-2. Front mount.....	186
Figure 7-3. Guard .....	187
Figure 7-4. Side control.....	188
Figure 7-5. Side control.....	188
Figure 7-6. Attack position.....	191
Figure 7-7. Relaxed position .....	192
Figure 7-8. Whirl movement .....	193
Figure 8-1. Fire team wedge formation .....	196
Figure 8-2. Fire team file formation .....	197
Figure 8-3. Rifle squad .....	198
Figure 8-4. Squad column with fire teams in column.....	198
Figure 8-5. Squad line .....	199
Figure 8-6. Squad file .....	199
Figure 8-7. Squad traveling .....	202
Figure 8-8. Squad traveling overwatch.....	202
Figure 8-9. Squad successive and alternating bounds .....	203
Figure 8-10. Stage 1 - Fighting position preparation.....	205
Figure 8-11. Stage 2 - Fighting position preparation.....	206
Figure 8-12. Stage 3 - Fighting position preparation.....	206
Figure 8-13. Stage 4 - Fighting position preparation.....	207
Figure 8-14. Hasty fighting position.....	208

TRADOC Pam 600-4

Figure 8-15. One-Soldier fighting position .....208  
Figure 8-16. Two-Soldier fighting position.....209  
Figure 8-17. Types of cover .....210  
Figure 8-18. Troops moving along a ravine .....210  
Figure 8-19. Fire team dispersed.....213  
Figure 8-20. Camouflaged Soldiers.....213  
Figure 8-21. Camouflaged fighting position being improved .....214  
Figure 8-22. Colors used in camouflage.....215  
Figure 8-23. Standardized MOPP levels .....217  
Figure 9-1. CMR process .....230  
Figure 9-2. Risk assessment matrix.....231

**THIS PAGE LEFT BLANK INTENTIONALLY.**

**Chapter 1**

**General Subjects**

**1-1. Army history**

a. “Resolved, that a General be appointed to command all the continental forces, raised, or to be raised, for the defense of American liberty.” The above resolution of the Second Continental Congress on 14 June 1775 established the beginnings of the United States (U.S.) Army, as we know it today. The next resolution unanimously selected George Washington as commanding general of the first Continental Army.

b. From Lexington to Trenton to Valley Forge, the Continental Army proved the critical force in fighting and winning the war for American Independence (see Declaration of Independence extracts beneath military quotation section). The Army has been the keeper of American freedom ever since.

c. From the outset, civilian control of the military was a governing principle of the American system. In 1787, the Constitution placed the military under the control of the President. His role as commander-in-chief requires every Soldier to follow and obey his orders.

d. In 1789, Congress created the Department of War to administer the military forces. The Army, now under the direction of the newly created cabinet, remained at strength of 60,000 or less from the end of the Revolution through the beginning of the Civil War. Although Congress intended that the Regular Army serve only as a supplement to local militias, the “regulars” ultimately played the crucial role in both the War of 1812 and the Mexican War (1846-48).

e. In December of 1860, the Army consisted of merely 16,000 officers and enlisted men. By 1865, Civil War expansion had increased that number to an astounding 1,000,000. Victory for the Union in the Civil War returned the Army to strength of only 25,000 troops.

f. An analysis of the Army’s role in the Spanish-American War (1898) revealed deficiencies in the War Department. After becoming Secretary of War in 1899, Elihu Root reorganized and revitalized the department. By the time the Army entered World War I in 1917, it was at its peak in terms of training and professionalism. Over 2,000,000 men followed General John J. Pershing to France as part of the American Expeditionary Force.

g. Following victory in the “War to End All Wars,” the Army remained at strength of approximately 125,000 from 1919 to 1939. However, when Nazi Germany invaded France in 1940, the U.S. Government re-instituted conscription (the draft) and forces ballooned to 1,640,000.

h. Japan attacked Pearl Harbor on 7 December 1941 and during the early 1940s, 8,300,000 men and women were part of a global effort to claim victory in World War II. From the Pacific Theater and bloody battles in the Philippines, to the D-Day invasion of Normandy

on 6 June 1944, American forces fought with courage to preserve freedom for the world.

i. Following the fall of the Nazis and the surrender of the Japanese in August 1945, the Army again contracted—this time to strength of approximately 500,000. Expansions followed during America's participation in the Korean and Vietnam Wars. Though it reduced in size during the interim periods of peace, the Army remained relatively large due to the looming presence of the Cold War.

j. When the forces of Communism fell in the late 1980s, civilian leaders began to re-evaluate the Army's role and it again went through a dramatic reduction in size. In 1991, the Army claimed a major victory in Desert Storm, defeating the Iraqi forces, the 4th-largest enemy in the world in 100 hours, and liberating the country of Kuwait. The Army also had a crucial role in bringing peace to many areas of conflict worldwide, as well as continuing to protect and advance American interests, throughout the 1990's.

k. The deadly terrorist attacks of 9/11/2001 on the U.S. brought the Army into a new era of global warfare against terrorism, and the persons and states, which supported these attacks on our Nation. In Afghanistan, the Taliban reign of terror was overthrown in Operation Enduring Freedom. During Operation Iraqi Freedom, the Army defeated the Iraqi forces completely, and ended the regime of Saddam Hussein. In these two countries, the Army is continuing efforts to restore stability and establish democracy. No matter how the Army changes or what the specific mission may be, the Soldier's role never changes: to support and defend the Constitution of the U.S. against all enemies, foreign and domestic.

## **1-2. Army heritage and tradition**

a. **The Army song.** "The Army Goes Rolling Along" is the official Army song. The words are shown in table 1-1. While played, it is proper to stand at attention. Known originally as, "The Caisson Song", the music was composed in 1908 by Lieutenant Edmund L. Gruber (who eventually rose to the grade of brigadier general). The Army dedicated it as the official Army Song on 11 November 1956 – Veteran's Day.

**Table 1-1**

**The Army song**

<b>The Army song</b>
<b>Intro</b>
<p>March along, sing our song,                  With the Army of the free.                  Count the brave, count the true,                  Who have fought to victory.                  We're the Army and proud of our name!                  We're the Army and proudly proclaim:</p>
<b>First Chorus</b>
<p>First to fight for the right,                  And to build the Nation's might,                  And THE ARMY GOES ROLLING ALONG.                  Proud of all we have done,                  Fighting till the battle's won,                  And THE ARMY GOES ROLLING ALONG.</p>
<b>Refrain</b>
<p>Then it's hi! hi! hey!                  The Army's on its way,                  Count off the cadence loud and strong (TWO! THREE!)                  For where e'er we go,                  You will always know,                  THAT THE ARMY GOES ROLLING ALONG.</p>
<b>Second Chorus</b>
<p>Valley Forge,                  Custer's ranks,                  San Juan Hill and Patton's tanks,                  And the Army went rolling along.                  Minute men from the start,                  Always fighting from the heart,                  And THE ARMY KEEPS ROLLING ALONG.</p>

**Table 1-1**  
**The Army Song, continued**

<b>Refrain</b>
Then it's hi! hi! hey! The Army's on its way, Count off the cadence loud and strong (TWO! THREE!) For where e'er we go, You will always know, That THE ARMY GOES ROLLING ALONG.
<b>Third Chorus</b>
Men in rags, Men who froze, Still that Army met its foes, And the Army went rolling along. Faith in God, Then we're right, And we'll fight with all our might, As THE ARMY KEEPS ROLLING ALONG.
<b>Refrain</b>
Then it's hi! hi! hey! The Army's on its way, Count off the cadence loud and strong (TWO! THREE!) For where e'er we go, You will always know, That THE ARMY GOES ROLLING ALONG.

b. **Uniforms.** Military uniforms identify military units. Until the nineteenth century, different military organizations used brightly colored clothing to distinguish themselves on the battlefield. This made it easier for a commander to control his forces. As weapons have become more lethal, survivability has become more crucial. Today, American military uniforms emphasize protective coloration. However, the Army has maintained the heritage of historical uniforms through more formal attire, such as Dress Blues.

c. **Formations.** Similar to uniforms, formations have their roots in organizing fighting units, so a commander could exercise control of his forces. The Greek Phalanx was one of the earliest formations and achieved the effects of massing combat power with shields and swords, organizing movement, and establishing camaraderie. Napoleon is



probably the most notable historical figure who mastered the use of Phalanx-like formations. Like uniforms, however, new weaponry forced a change in tactics. Modern-day formations, such as the wedge, emphasize survivability and maneuver – as opposed to sheer mass. The Army carries on the traditions of Napoleonic formations in the form of drill and ceremony.

d. **Organizational flags and guidons.** Every military unit has its own colors. Colors represent the heart of a unit and are always located with the commander. Units receive streamers for their achievements that attach to their guidon above the colors. Capturing a unit's colors represents defeating the unit. Units throughout history have fought to the death to protect their colors. The image of the American flag accompanying General George Washington as he crosses the Delaware River signifies the importance of colors on the battlefield – from the Nation's symbol down to the company guidon.



**Figure 1-1. General Washington crossing the Delaware River**

### **1-3. Army organization**

a. **Active Army and Reserve Component.** The U.S. Army maintains two parts: the Active Army and the Reserve Component (RC). The Active Army consists of Soldiers who are on full-time active duty. The RC consists of the Army National Guard (ARNG) and the U.S. Army Reserve (USAR). The RC receives military training and is ready to be called to active duty as necessary.

b. **Army unit organization.** Army units are organized in several ways, but the following example is typical:

(1) The squad is the smallest unit, consisting of eight to 10 Soldiers. The squad leader is a noncommissioned officer (NCO).

(2) The platoon includes the platoon leader (2LT/1LT), platoon sergeant (SFC), and two or more squads.

(3) The company includes the company commander (CPT), first sergeant (1SG), and two or more platoons.

(4) The battalion includes the battalion commander (LTC), his staff and headquarters, the command sergeant major (CSM), and approximately 3-5 companies.

(5) The brigade includes the brigade commander (COL), command sergeant major, a headquarters, and approximately three to six battalions.

(6) The division structure is the capstone element of our Army. It includes three maneuver (armor or infantry) brigades, as well as several combat support and service support brigades or battalions. As shown in table 1-1, there are currently 10 active divisions, each commanded by a major general (two-stars).

**Table 1-2**  
**Active U.S. Army divisions**

Division Name	Location
1 <sup>st</sup> Infantry Division	Germany (HQ)
2 <sup>nd</sup> Infantry Division	Korea
3 <sup>rd</sup> Infantry Division	Ft. Stewart, Georgia (HQ)
4 <sup>th</sup> Infantry Division	Ft. Hood, Texas (HQ)
10 <sup>th</sup> Mountain Division	Ft. Drum, New York
25 <sup>th</sup> Infantry Division	Scholfield Barracks, Hawaii
82 <sup>nd</sup> Airborne Division	Ft. Bragg, North Carolina
101 <sup>st</sup> Airborne Division	Ft. Campbell, Kentucky
1 <sup>st</sup> Armored Division	Germany (HQ)
1 <sup>st</sup> Cavalry Division	Ft. Hood, Texas

(7) Organizations higher than the division include major Army commands, Corps, Army, and in times of war, the theater.

#### **1-4. Chain of command**

a. Your chain of command has legal responsibility for your training, discipline, and overall welfare. It includes the NCO directly over you (your first-line supervisor), to your company, battalion, brigade, and division commanders, to the civilians charged with authorizing Army actions, all the way up to our Commander-in-Chief, the President of the United States.

b. Complete the names of the individuals in your chain of command in table 1-2. Memorize their names and grades/positions.

**Table 1-3**

**My chain of command**

Position	Name
First Line Supervisor	
Company Commander	
Battalion Commander	
Brigade Commander	
Division/Post Commander	
TRADOC Commander	
Chief of Staff of the Army	
Secretary of the Army	
Secretary of Defense	
President of the United States	

**1-5. Noncommissioned officer (NCO) support channel**

- a. The NCO support channel, while not directly a part of your chain of command, is often just as important, and includes the NCOs (platoon sergeant [PSG], first sergeant [1SG], and command sergeant major [CSM]) who play a vital role in your unit.
- b. Complete the names of individuals of your NCO support channel in table 1-3. Memorize their names and grades/positions.

**Table 1-4**

**My NCO support channel**

Position	Name
Squad Leader	
Platoon Sergeant	
First Sergeant	
Battalion CSM	
Brigade CSM	
Division/Post CSM	
TRADOC CSM	
Sergeant Major of the Army	

**1-6. Grade insignia**

- a. You must be able to recognize the grades of Army personnel immediately.
- b. **Officers.**
  - (1) The highest-ranking officer is a five-star general (General of the Army); the lowest officer grade is a second lieutenant (O1).
  - (2) Figure 1-2 shows the officer grades with their insignia.
  - (3) Address all personnel with the grade of general as "General (last name)" regardless of the number of stars.

- (4) Address colonels (O6) and lieutenant colonels (O5) as "Colonel (last name)".
- (5) Address majors (O4) as "Major (last name)".
- (6) Address captains (O3) as "Captain (last name)".
- (7) Address both second lieutenants (O1) and first lieutenants (O2) as "Lieutenant (last name)".

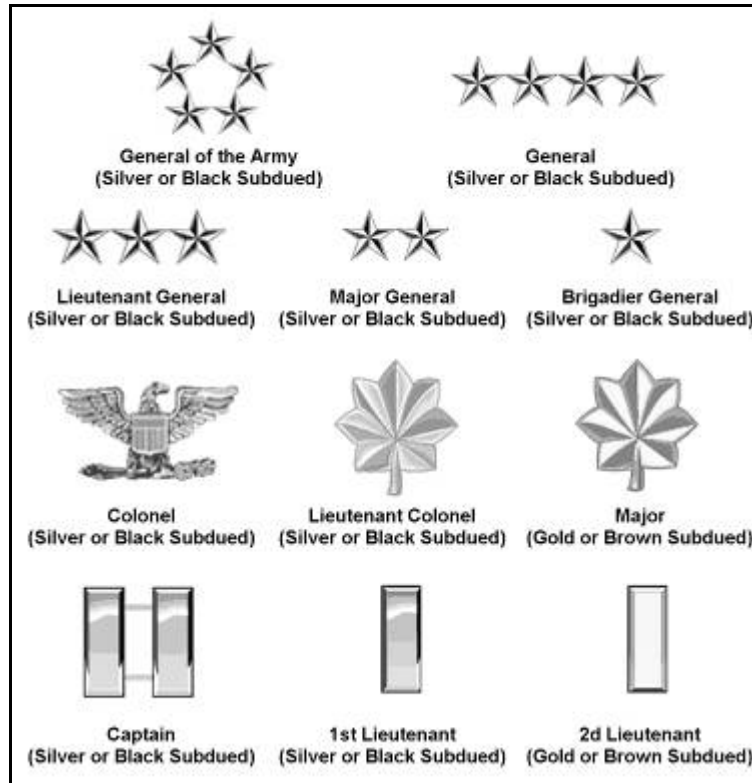

Figure 1-2. Officer insignia

**c. Warrant officers.**

- (1) The highest-ranking warrant officer grade is a chief warrant five (CW5); the lowest is a warrant officer one (WO1).
- (2) Figure 1-3 shows warrant officer grades with their insignia.
- (3) Address warrants as "Mr. (last name)" or "Ms. (last name)".

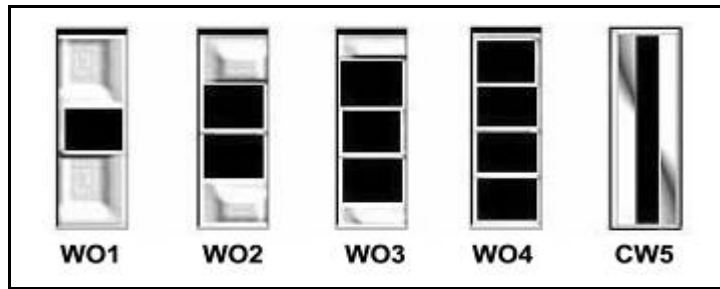

Figure 1-3. Warrant officer insignia

d. **Enlisted.**

(1) The highest enlisted grade is the sergeant major of the Army (E9); the lowest is a private (E1).

(2) Figure 1-4 shows the enlisted grades with their insignia.

(3) Address privates (E1 and E2) and privates first class (E3) as "Private (last name)."

(4) Address specialists (E4) as "Specialist (last name)".

(5) Address sergeants (E5), staff sergeants (E6), sergeants first class (E7), and master sergeants (E8) as "Sergeant (last name)".

(6) Address first sergeants as "First Sergeant (last name)".

(7) Address sergeants major (E9) as "Sergeant Major (last name)".

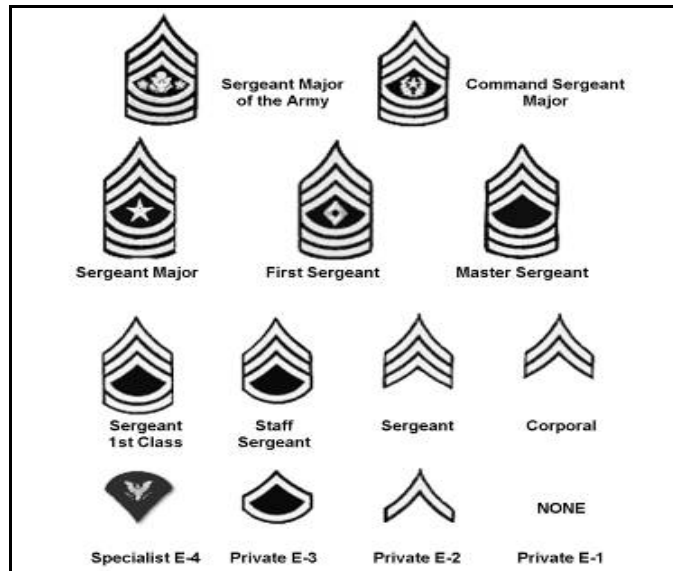

Figure 1-4. Enlisted insignia

e. Grade abbreviations are in table 1-4.

**Table 1-5**  
**Grade abbreviations**

Grade Abbreviation	Grade
<b>OFFICERS</b>	
GEN	General
LTG	Lieutenant General
MG	Major General
BG	Brigadier General
COL	Colonel
LTC	Lieutenant Colonel
MAJ	Major
CPT	Captain
1LT	First Lieutenant
2LT	Second Lieutenant
CWO	Chief Warrant Officer
WO	Warrant Officer
<b>ENLISTED</b>	
CSM	Command Sergeant Major
SGM	Sergeant Major
1SG	First Sergeant
MSG	Master Sergeant
SFC	Sergeant First Class
SSG	Staff Sergeant
SGT	Sergeant
CPL	Corporal
SPC	Specialist
PFC	Private First Class
PV2	Private E-2
PVT	Private

### 1-7. Military time

- a. All U.S. military services tell time by using the numbers "1" to "24" for the 24 hours in a day. A day begins at one minute after midnight and ends at midnight the same day. For example, eight minutes after midnight (12:08 am) is written in military time as "0008".
- b. Thirty-three minutes after two o'clock in the afternoon (2:33 pm) is written as "1433".

(1) Figure 1-5 shows a time conversion chart.

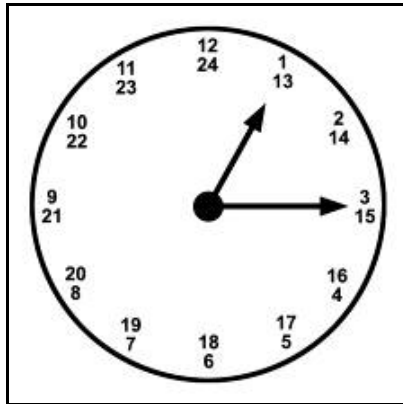

Figure 1-5. Military/civilian clock

(2) Table 1-5 shows civilian to military time conversions.

**Table 1-6**  
Civilian/military time conversion chart

Civilian Time	Military Time
12:01 AM	0001
1:00 AM	0100
2:00 AM	0200
3:00 AM	0300
4:00 AM	0400
5:00 AM	0500
6:00 AM	0600
7:00 AM	0700
8:00 AM	0800
9:00 AM	0900
10:00 AM	1000
11:00 AM	1100
12:00 Noon	1200
1:00 PM	1300
2:00 PM	1400
3:00 PM	1500
4:00 PM	1600
5:00 PM	1700
6:00 PM	1800
7:00 PM	1900
8:00 PM	2000
9:00 PM	2100
10:00 PM	2200
11:00 PM	2300
11:59 PM	2359
12:00 Midnight	0000

**1-8. Customs and courtesies****a. Saluting.**

(1) The origin of the hand salute is uncertain. Some historians believe it began in late Roman times when assassinations were common. A citizen who wanted to see a public official had to approach with his right hand raised to show that he did not hold a weapon. Knights in armor raised visors with the right hand when meeting a comrade. This practice gradually became a way of showing respect and in early American history sometimes involved removing the hat. By 1820, the motion was modified to touching the hat, and since then has become the hand salute used today.

(2) During your time in the Army, you salute to show respect toward an officer, flag, or our country. The proper way to salute with or without a weapon is described in Field Manual (FM) 3-21.5, paragraph 4-4. The rules of saluting are as follow:

(a) When you meet someone outside, salute as soon as you recognize that he or she is an officer, or if you are walking toward the officer, wait until you are about six steps away.

(b) Salute all officers (recognized by grade) in official vehicles identified by special plates or flags.

(c) Salute only on command when in formation.

(d) If in a group and an officer approaches, the first Soldier to recognize the officer calls the group to attention and all personnel salute.

(e) If you approach an officer while you are double-timing alone, assume quick time march and render the hand salute. When the salute is returned, execute order arms and resume double-timing.

(f) The salute is always initiated by the subordinate and terminated only after acknowledgment by the individual saluted.

(g) Accompany the salute with an appropriate greeting, such as, "Good morning/afternoon, sir/ma'am."

(h) Salutes are not required to be rendered by or to personnel who are driving or riding in privately owned vehicles.

(i) It is not customary for enlisted personnel to exchange salutes, except in some ceremonial situations.

(j) Never render a salute with a noticeable object in your mouth or right hand. This includes cell phones and items that are distracting to your military bearing.

(k) If you are on detail and an officer approaches, salute if you are in charge of the detail. Otherwise, continue to work. When spoken to, come to the position of attention while addressing an officer.

**b. Hand salute.** The hand salute is a one-count movement. The command is **Present, ARMS**. The hand salute may be executed while marching. When marching, only the soldier in charge of the formation salutes and acknowledges salutes. When double-timing, an individual soldier must come to quick time before saluting.



TRADOC Pam 600-4

(1) When wearing headgear with a visor (with or without glasses), on the command of execution **ARMS**, raise the right hand sharply, fingers and thumb extended and joined, palm facing down, and place the tip of the right forefinger on the rim of the visor slightly to the right of the right eye. The outer edge of the hand is barely canted downward so that neither the back of the hand nor the palm is clearly visible from the front. The hand and wrist are straight, the elbow inclined slightly forward, and the upper arm horizontal (see figure 1-6).

(2) When wearing headgear without a visor (or uncovered) and not wearing glasses, execute the hand salute in the same manner as previously described, except touch the tip of the right forefinger to the forehead near and slightly to the right of the right eyebrow (see figure 1-7).

(3) When wearing headgear without a visor (or uncovered) and wearing glasses, execute the Hand Salute in the same manner as previously described, except touch the tip of the right forefinger to that point on the glasses where the temple piece of the frame meets the right edge of the right brow (figure 1-8).

(4) Order arms from the hand salute is a one-count movement. The command is **Order, ARMS**. On the command of execution **ARMS**, return the hand sharply to the side, resuming the position of attention.

(5) When reporting or rendering courtesy to an individual, turn the head and eyes toward the person addressed and simultaneously salute. In this situation, the actions are executed without command. The salute is initiated by the subordinate at the appropriate time (six paces) and terminated upon acknowledgment.



**Figure 1-6. Hand salute with visor**



**Figure 1-7. Hand salute with beret or uncovered**



**Figure 1-8. Hand salute with beret and wearing glasses**

**c. Rendering honor to the flag.** The flag of the U.S. is the symbol of our Nation. The union, white stars on a field of blue, is the honor point of the flag. The union of the flag and the flag itself, when in company with other flags, are always given the honor position, which is on the right. Rules for displaying the flag follow.

(1) The flag of the U.S. is displayed outdoors at all Army installations.

(2) Only one flag of the U.S. is flown at one time at any continental United States Army installation except as authorized by the commanding generals of major Army commands.

(3) The flag is displayed daily from reveille to retreat. If illuminated, it may be displayed at night during special events or on special occasions deemed appropriate by the commander.

#### TRADOC Pam 600-4

(4) The flag of the U.S. is the only flag that may be flown from a flagpole over an Army installation. An exception is the Minuteman flag that, if awarded, may be flown beneath the flag of the U.S.

(5) In unusual circumstances not covered in the Army regulations, the judgment of the senior Army individual present will determine whether the flag shall be displayed on a specific occasion.

(6) When the flag is being raised in the morning or lowered in the evening, stand at attention on the first note of Reveille or "To the Colors." "Colors" refer to the flag of the U.S. and can include the unit flag. Give the required salute. If you are actively involved a duty that would be hampered by saluting, you do not need to salute. You normally face the flag when saluting, unless duty requires you to face in some other direction. At the conclusion of the ceremony, resume your regular duties.

(7) The flag, when flown at half-staff, is hoisted to the peak/top of the flagpole and then lowered to the half-staff position. At the end of the day, the flag is hoisted to the peak before lowered. "Half-staff" means lowering the flag to one-half the distance between the top and bottom of the staff. In the early days of our country, no regulations existed for flying the flag at half-staff and, as a result, there were many conflicting policies. On March 1, 1954, President Dwight Eisenhower issued a proclamation on the proper times. The flag should fly at half-staff for 30 days after the death of the president or a former president at all federal buildings, grounds, and naval vessels throughout the U.S. and its territories and possessions. The flag is flown at half-staff for 10 days after the death of the vice president, the chief justice, or a retired chief justice of the U.S. Supreme Court, and the speaker of the House of Representatives.

(8) Whenever Reveille is played, and you are not in formation and not in a vehicle, come to attention at the first note, face the flag, and give the required salute. If no flag is near, face the music and salute. If you are in formation, salute only on the order "Present arms." If you are in civilian clothing, stand at attention and place your right hand over your heart. These honors also apply to the national anthems of foreign countries during ceremonies or parades. The words to the National Anthem appear beneath the Preamble to the Constitution in this chapter (see Para 1-12).

(9) Vehicles in motion should stop. If you are in a car or on a motorcycle, dismount and salute. If you are with a group in a military vehicle or bus, remain in the vehicle. The individual in charge will dismount and salute.

(10) When you pass or passed by colors, which are presented, paraded, or displayed, salute when the colors are six paces from you. Hold the salute until the colors are six paces beyond you.

#### d. **Courtesies.**

(1) The following rules will help you conduct yourself appropriately in the presence of officers and those senior in grade:

- (a) When talking to an officer, stand at attention unless given the order "At ease." When you are dismissed, or when the officer departs, come to attention and salute.
- (b) When an officer enters a room, the first Soldier to recognize the officer calls personnel in the room to attention but does not salute. When a Soldier reports indoors render a salute to the officer.
- (c) When accompanying a senior, walk on his left.
- (d) When entering or exiting a vehicle, the junior grade person is the first to enter, and the senior in grade is the first to exit.
- (e) When an officer enters a dining facility, unless he directs otherwise or a more senior officer is already present, the diners will be given the order "At ease" by the first person who sees the officer. You will remain seated at ease and will continue eating unless the officer directs otherwise. If you are directly addressed, you should rise to attention when seated in a chair. If you are seated on a bench, stop eating and sit at attention until the conversation ends.  
**NOTE:** The officer or NCO may give the directive "Carry on." This means the Soldier or Soldiers should continue with whatever they were doing previously. This same directive is used in many other situations outside of formation, such as in the barracks and break areas.
- (f) When outdoors and approached by an NCO, you should stand (when seated) and greet the NCO by saying, "Good morning, sergeant""Good afternoon, sergeant," or "Good evening, sergeant (last name, if known)".
- (g) When you report to an officer for any reason, it is important to make a good first impression. If you are outdoors, approach the officer to whom you are reporting and stop about two steps from him, assuming the position of attention. Give the proper salute and say, for example, "Sir/Ma'am, Private Smith reports." If you are indoors, use the same procedures as above, except remove your headgear before reporting. However, if you are armed, do not remove your headgear.

### **1-9. Role of the chaplain**

- a. Each battalion in the Army has its own chaplain (normally a CPT). The chaplain and his assistant form the unit's ministry team. The chaplain is responsible for providing spiritual support to every Soldier in the unit. Although chaplains are part of a particular denomination, their mission is to ensure the spiritual needs of every Soldier are met.
- b. Chaplains hold weekly services (while in garrison and in the field), are available for individual counseling, and are one of two members of the military who retain the privilege of confidentiality (the other being Army lawyers). The chaplain also plays a key role in helping promote programs, such as suicide prevention.
- c. In the IET environment, chaplains are of particular value in helping Soldiers succeed under difficult and stressful conditions. They assist the commander in teaching, displaying, and instilling the Army Values, and in maintaining high morale within the unit.

TRADOC Pam 600-4

d. Each of the following levels of the Army organization has its own chaplain. Chaplain grades at the brigade level would be a MAJ or LTC; the division level a LTC, and the installation a COL. The Chief of Chaplains is a Major General.

e. Chaplain are available to provide spiritual counseling to all Soldiers and have many resources to assist in counseling and/or support (for example., pamphlets, prayer cards, books, and other religious material)."

**1-10. Military quotations**

Quotations can provide inspiration at various times during our lives. See table 1-6, for inspiring military quotes.

**Table 1-7  
Military quotations**

<b>Quotation</b>	<b>Author</b>
"In war, there is no substitute for victory."	General Douglas MacArthur
"I have never taken any command into battle with the slightest desire to come out of it alive unless I won."	General P.H. Sheridan
"War is an ugly thing but not the ugliest of things. The decayed and degraded state of mind that thinks nothing is worth fighting for is far worse."	John Stuart Mill
"Only the dead have seen the end of war."	Plato
"Battle is the ultimate to which the whole life's labor of a [Soldier] should be directed. He may live to the age of retirement without seeing a battle; still, he must always be getting ready for it exactly as if he knew the hour of the day it is to break upon him. And then, whether it comes early or late, he must be willing to fight – he must fight."	BG Charles F. Smith (1861)
"God grants liberty only to those who love it and are always ready to defend it."	Daniel Webster
"Let every nation know, whether it wishes us well or ill, that we shall pay any price, bear any burden, meet any hardship, support any friend, oppose any foe, to assure the survival and success of liberty."	President John F. Kennedy
"I regret that I have but one life to lose for my country."	Nathan Hale
"To be prepared for war is one of the most effectual means of preserving the peace."	President George Washington

**Table 1-6**  
**Military quotations, continued**

<b>Quotation</b>	<b>Author</b>
“Eternal vigilance is the price of freedom.”	Thomas Jefferson
“Winning is not a sometime thing. You do not win occasionally. You do not do things right occasionally. You do them right all the time.”	Vince Lombardi
“When duty whispers – ‘low, thou must’ – you must reply: ‘I can!’ ”	Ralph Waldo Emerson
“When your shot is exhausted, knock down the enemy with the stock of your rifle. If the rifle stock be broken, bite with your teeth.”	Russian Military Reader
“You cannot be disciplined in great things and undisciplined in small things. There is only one sort of discipline – perfect discipline.”	General George S. Patton, Jr.
“You gain strength, courage, and confidence by every experience in which you really stop to look fear in the face. You must do the thing you think you cannot do.”	Eleanor Roosevelt
“Encourage us in our endeavor to live above the common level of life. Help us to choose the harder right instead of the easier wrong.”	West Point Cadet Prayer
“Invincibility depends on one’s self; the enemy’s vulnerability on him.”	Sun Tzu
“Perpetual optimism is a force multiplier.”	General Colin Powell

#### **1-11. Declaration of Independence (extract)**

When in the course of human events, it becomes necessary for one people to dissolve the political bands which have connected them with another, and to assume, among the powers of the earth, the separate and equal station to which the laws of nature and of nature's God entitle them, a decent respect to the opinions of mankind requires that they should declare the causes which impel them to the separation. We hold these truths to be self evident, that all men are created equal, that they are endowed by their Creator with certain unalienable rights, that among these are life, liberty, and the pursuit of happiness. That to secure these rights, governments are instituted among men, deriving their just powers from the consent of the governed, that whenever any form of government becomes destructive of these ends, it is the right of the people to alter or to abolish it, and to institute new

## TRADOC Pam 600-4

government.... Prudence, indeed, will dictate that Governments long established should not be changed for light and transient causes.... But when a long train of abuses and usurpations, pursuing invariably the same object evinces a design to reduce them under absolute despotism, it is their right, it is their duty, to throw off such government, and to provide new guards for their future security. Such has been the patient sufferance of these colonies; and such is now the necessity, which constrains them to alter their former systems of government.

The history of the present King of Great Britain is a history of repeated injuries and usurpations, all having in direct object the establishment of an absolute tyranny over these States. To prove this, let facts be submitted to a candid world.... He has obstructed the administration of justice, by refusing his assent to laws for establishing judiciary powers. He has made judges dependent on his will alone, for the tenure of their offices, and the amount and payment of their salaries.... He has kept among us, in times of peace, standing armies without the consent of our legislatures.

He has affected to render the military independent of and superior to the civil power. For quartering large bodies of armed troops among us: For protecting them, by a mock trial, from punishment for any murders which they should commit on the inhabitants of these States: For cutting off our trade with all parts of the world: For imposing taxes on us without our consent: For depriving us, in many cases, of the benefits of trial by jury.

He has plundered our seas, ravaged our coasts, burnt our towns, and destroyed the lives of our people.... We, therefore, the Representatives of the United States of America, in General Congress, assembled, appealing to the Supreme Judge of the world for the rectitude of our intentions, do, in the name, and by the authority of the good people of these Colonies, solemnly publish and declare, that these United Colonies are, and of right ought to be free and independent States; that they are absolved from all allegiance to the British Crown, and that all political connection between them and the State of Great Britain, is and ought to be totally dissolved; and that as free and independent States, they have full power to levy war, conclude peace, contract alliances, establish commerce, and to do all other acts and things which independent States may of right do.

And for the support of this Declaration, with a firm reliance on the protection of Divine Providence, we mutually pledge to each other our lives, our fortunes, and our sacred honor.

### **1-12. Preamble to the Constitution of the United States**

We the People of the United States of America, in Order to form a more perfect Union, establish Justice, insure domestic Tranquility, provide for the common defense, promote the general Welfare, and

secure the Blessings of Liberty to ourselves and our Posterity, do ordain and establish this Constitution for the United States of America.

### **1-13. The Star-Spangled Banner - The National Anthem**

By Francis Scott Key, 1814

O say, can you see, by the dawn's early light—  
 What so proudly we hail'd, at the twilight's last gleaming.  
 Whose broad stripes and bright stars, thro' the perilous fight—  
 O'er the ramparts we watch'd, were so gallantly streaming.  
 And the rockets' red glare, the bombs bursting in air—  
 Gave proof thro' the night, that our flag was still there:  
 O say, does that star-spangled banner yet wave—  
 O'er the land of the free, and the home of the brave!  
 On the shore dimly seen, thro' the mists of the deep—  
 Where the foe's haughty host, in dread silence reposes.  
 What is that which the breeze, o'er the towering steep—  
 As it fitfully blows, half conceals, half discloses.  
 Now it catches the gleam, of the morning's first beam—  
 In full glory reflected, now shines on the stream:  
 'Tis the star-spangled banner: O, long may it wave—  
 O'er the land of the free, and the home of the brave!  
 And where is that band, who so vauntingly swore—  
 That the havoc of war, and the battle's confusion.  
 A home and a country, should leave us no more—  
 Their blood has wash'd out, their foul footsteps' pollution.  
 No refuge could save, the hireling and slave—  
 From the terror of flight, or the gloom of the grave:  
 And the star-spangled banner, in triumph doth wave—  
 O'er the land of the free, and the home of the brave!  
 O thus be it ever, when free-men shall stand—  
 Between their lov'd home, and the war's desolation.  
 Blest with vict'ry and peace, may the heav'n-rescued land—  
 Praise the Pow'r that hath made and preserv'd us a Nation!  
 Then conquer we must, when our cause it is just—  
 And this be our motto: "In God is our trust!"  
 And the star-spangled banner in triumph shall wave—  
 O'er the land of the free, and the home of the brave!

### **1-14. Pledge of Allegiance**

I pledge allegiance to the Flag of the United States of America,  
 And to the Republic for which it stands:  
 One Nation, under God,  
 Indivisible, with liberty and justice for all.



**1-15. Soldier and family benefits**

**My Army Benefits Web site** is an official Army benefits resource for the Regular Army, ARNG, USAR, family members and retirees. My Army Benefits is your one-stop shop for the latest, most-up-to-date benefits information on subjects such as:

- \*Pay
- \*Education
- \*Family Services
- \*Health Care & Life Insurance
- \*Transitioning & Retirement
- \*Soldier Benefits
- \*Casualty & Survivor
- \*Veterans Affairs
- \*Social Security
- \*Army Wounded Warriors

Active duty AKO account holders who log into the

<https://myarmybenefits.us.army.mil> section can produce personalized reports to use their Defense Enrollment Eligibility System data to calculate survivor, education and retirement benefits, annuities, and lump-sum payments. Add investments, insurance and Servicemen's Group Life Insurance (SGLI) or use the "what if" capability to see the impacts of marriage, having children or retiring at a projected date and grade to complete your financial picture. Ensure you use the official Army link provided above and not commercial sources.

a. **TRICARE (medical coverage).**

(1) TRICARE is the Department of Defense (DOD) health care program or the military's equivalent of a medical insurance provider.

(2) Active Duty Soldier's are automatically enrolled in the program and receive full medical benefits through a primary care provider at their local military facility.

(3) Active duty family members and retirees under the age of 65 are also eligible for medical coverage (your family members are eligible from the first day you enter the Army).

(4) Sponsors must enroll their family members in the program through the local Health Benefits Advisor. (This is an important step – you need to ensure that you have enrolled your family in order for them to receive medical care.)

(5) You may choose from three TRICARE programs.

(a) TRICARE Prime.

(b) Active duty Soldiers are automatically enrolled in TRICARE Prime (they have no choice), and most sponsors choose this program for their family members.

(c) TRICARE Prime is similar to an HMO (Health Maintenance Organization).

(d) You and your family members are assigned to a primary care manager (usually at the closest military facility), who will administer to most of your medical needs.

(e) Your primary care manager will refer you to a specialist, as necessary.

(f) The great advantage of TRICARE Prime is most of your medical expenses are paid for.

(g) However, you must visit your primary care manager first for all health care issues.

- (h) TRICARE Standard.
- (i) With TRICARE Standard, you are able to choose your own civilian doctor.
- (j) However, you must pay a yearly deductible (approximately \$100 per person), as well as 20% of all medical expenses.
- (k) TRICARE Extra.
- (l) With TRICARE Extra, you may select from a list of TRICARE participating civilian doctors.
- (m) You are responsible for 15% of all medical expenses.

(6) Below are a few commonly asked questions about TRICARE.

**QUESTION 1:** I am a basic training Soldier. My family members are not here with me. How will they get medical care in my hometown?

**ANSWER 1:** They may enroll in TRICARE Prime if it is available in that area, or they may seek care under TRICARE Extra or TRICARE Standard. The most important step is to talk to the local health benefits advisor to get your family enrolled in your program of choice.

**QUESTION 2:** What are the costs to enroll my family in TRICARE Prime?

**ANSWER 2:** There is no cost for active duty family members enrollment in TRICARE Prime. There may be modest payments for inpatient stays at civilian hospitals (approximately \$10 per day) or a cost-share when they are referred to civilian doctors (approximately \$6 per visit).

**QUESTION 3:** If my family and I are away from our local military facility, how do we receive medical care?

**ANSWER 3:** In an emergency (threat to life, limb, eyesight, or broken bones), simply go to the nearest medical facility (civilian or military). If there is no emergency, contact your primary care manager for approval to see a civilian doctor. This makes it important to keep your primary care manager's phone number with you when you are on leave or away from your normal military post.

**b. Dental coverage.**

- (1) Active duty Soldiers receive full dental and orthodontic care through military providers.
- (2) However, these services are not available to family members, and dental care is not included as a part of TRICARE coverage.
- (3) You may enroll your family members in a separate dental insurance program through your local personnel action center (PAC).
- (4) The insurance costs approximately \$8 to \$20 per month depending on the number of family members you have.
- (5) It covers the costs of regular cleanings, as well as providing partial payment for other procedures and surgery.

**c. Legal benefits.**

- (1) Judge Advocate General Services.
  - (a) The Staff Judge Advocate at each Army post is available to assist Soldiers with legal matters such as:
    - (b) Drafting a will or power of attorney.

TRADOC Pam 600-4

(c) Filing claims against the government for damaged property.

(d) General legal questions.

(2) Trial Defense Services.

(a) In the event that you encounter legal problems during your military career, the Army provides defense attorneys (at no cost to you), who will help you understand your rights and ensure you are afforded due process.

(b) The Trial Defense Service at your local post assists Soldiers with issues concerning chapters (removal from the Army), non-judicial punishment under Article 15 of the UCMJ, and other more serious Uniform Code of Military Justice (UCMJ) offenses (courts-martial).

(c) While they may give you limited advice, the Trial Defense Service does not provide legal assistance for matters supervised by a civilian court.

**d. Servicemen's Group Life Insurance (SGLI).**

(1) The SGLI program provides a term life insurance policy.

(2) All Soldiers on active duty are automatically insured for a maximum of \$400,000 unless you decline or reduce the coverage. The cost for SGLI is deducted from your paycheck each month unless you state in writing that you do not want the insurance.

(3) Family members may be insured by SGLI up to \$100,000 in coverage and cost is dependent on their age.

(4) Coverage in smaller quantities is available at lower monthly rates.

(5) SGLI changes will be executed (1 March 2009) via the Defense Integrated Military Human Resources System (DIMHRS) self-service.

(6) SGLI is an excellent program for military personnel because it:

(a) Is available at a low cost.

(b) Pays in addition to any other survivor benefits.

(c) Ensures your designated survivor will receive compensation, even if your event is the result of combat or other high-risk military duties.

**e. Housing.**

(1) On-post housing.

(a) The Army provides government quarters or a housing allowance for all Soldiers.

(b) Single Soldiers normally live on post in the unit's housing area or the bachelor's enlisted quarters.

(c) Those in the grade of SFC and above may choose to live off post with permission from their commander.

(d) Soldiers in pay grade E4, with two or more years of service, and in pay grades E5 and above (with family member(s)), are eligible for government-owned or controlled family housing.

(e) Installations with adequate quarters assign housing as soon as possible.

(f) If housing is not immediately available, your name is placed on a waiting list and you must find off-post accommodations.

(2) Off-Post Housing.

- (a) If you live off post, you will receive a basic allowance for quarters based on your grade.
- (b) The money is intended to pay for approximately 80% of the cost of rent and utilities.
- (c) In most areas, you will also receive a variable housing allowance; this amount depends on the cost of housing in the area.
- (d) For example, a Soldier stationed in Washington, D.C., receives a greater variable housing allowance than one stationed at Fort Benning, Georgia, because living in the D.C. area costs more than living near Columbus, Georgia.
- (e) The combination of your allowance for quarters and variable housing allowance is called basic allowance for housing (BAH).
- (f) BAH is not taxed as income when filing federal income taxes.

**f. Army and Air Force Exchange Service and commissary.**

1. Army and Air Force Exchange Service.

- (a) The Exchange is similar to a department store.
- (b) There is no state sales tax on exchange items and prices are often very reasonable.
- (c) You may purchase items for your own personal use or for gifts, but you may not buy items for resale.
- (d) As long as you are on active duty, retired, on special reserve duty, or are a family member, you may use any military exchange facility in the U.S. and some overseas areas.

(2) Commissary.

- (a) The commissary is a supermarket, used by all military personnel and their family members.
- (b) Commissaries usually sell food at a lower price than civilian stores, particularly overseas.
- (c) The government appropriates money to keep commissaries operating, and you can save money by shopping at the commissary.

**g. Leave.**

- (1) Leave is awarded at the rate of 1.25 days per pay period (DIMHRS).
- (2) Subject to the approval of your chain of command and the requirements of your unit's mission, you can use this leave at your own convenience for any purpose you choose (if you do not use all 30 days, the excess carries over to the following year not to exceed 60 days).
- (3) A line on your leave and earnings statement annotates your leave. Check this line each month to see how much leave you have available.
- (4) As a new Soldier, you will have very few days of leave accrued.
- (5) In the case of emergencies or special circumstances, your commander is authorized to advance a certain number of days.

**h. Army family team building (AFTB).**

- (1) The purpose of the AFTB program is to increase Soldier and family readiness, which in turn increases mission accomplishment.

## TRADOC Pam 600-4

(2) AFTB's mission is to educate and train all of the Army in knowledge, skills, and behaviors designed to prepare our Army families to move successfully into the future for Soldiers and family members to be able to help themselves during times of stability and deployment.

(3) Each installation has an AFTB program with three levels.

(a) Level I focuses on the basic skills and knowledge needed to live the military life... teaches individuals Army basics, how to manage personal affairs and sources to find assistance, if necessary.

(b) Level II allows participants to grow into a community leader.

(c) Level III goes into inspiring and mentoring others into leadership positions.

(4) AFTB levels can be taken online at [www.MyArmyLifeToo.com](http://www.MyArmyLifeToo.com).

### **1-16. Promotions**

#### **a. E-1 to E-2.**

(1) A private will be automatically advanced to E-2 after completing six months of service (barring any adverse legal actions).

(2) Local commanders may recognize outstanding performance by employing a promotion waiver to promote privates to PV2 after only four months.

(3) Promotion waivers are limited in number and only available to the very best Soldiers.

#### **b. E-2 to E-3.**

(1) Commanders may promote E-2s with 12 months of time in service and four months time in grade with chain of command recommendation.

(2) Promotion waivers for outstanding performers are available at six months time in service and two months time in grade.

#### **c. E-3 to E-4.**

(1) An E-3 is eligible for promotion to E-4 with 24 months time in service and 6 months time in grade. Commanders may promote with chain of command recommendation.

(2) Promotion waivers for outstanding performers are available at 18 months time in service and 3 months time in grade.

#### **d. E-4 to E-5.**

(1) E-4s must go before a local promotion board to gain eligibility for advancement to the grade of E-5, with the NCO support channel recommendation when they have reached the promotion point cut-off.

(2) The promotion board tests you on a number of items including:

(a) Leadership competency.

(b) Basic Soldier knowledge and skills.

(c) Oral communication skills.

(d) Personal appearance.

(e) Bearing.

(f) Self confidence.

(3) When you succeed at the promotion board, your NCO support channel will recommend you for promotion, and based on the Army

wide point system, you will advance to E-5 when you have met the “promotion point cut-off” for your MOS.

### **1-17. Managing personal finances**

It is your duty as a Soldier to fulfill all of your financial obligations and provide for your family members. There are several key components to achieving this task. Take action to ensure you are receiving your paycheck and have financial systems in place to meet your needs. Inquire with other individuals about the services they receive and make educated financial decisions.

#### **a. MyPay.**

Soldiers can review and print their leave and earnings statement, thrift savings plan investments, savings deposit program Statement, allotments, savings bonds purchases, and direct deposit amounts at <https://mypay.dfas.mil/mypay.aspx>. Ensure you visit the official military web site only.

#### **b Sure-pay program.**

(1) The Army requires all Soldiers to enroll in the sure-pay program.

(2) This means that you must have your paycheck deposited directly to a checking or savings account.

(3) If you close or change this account, you must ensure that you go to your local PAC and fill out the proper forms to update your Sure-Pay data.

(4) The Army will pay you once per month on the first of each month, or twice per month on the 1<sup>st</sup> and the 15<sup>th</sup> -your choice based on your budget requirements. When DIMHRS takes affect, you will be 2 times a month.

(5) You must carefully review your monthly leave and earning statement to ensure that your pay is being deposited properly and you are receiving all of the benefits (Base Pay, BAH, etc.) that you are entitled to.

#### **c. Bank deposit account.**

(1) Some key items to consider when choosing the financial institution at which you will keep your direct deposit account are:

(a) Inquire if there a monthly service charge for maintaining a checking account. Numerous institutions offer free checking, as long as you have set up Sure-Pay.

b) Inquire if there a charge for using ATMs. Cash withdrawal charges can be expensive, and often banks do not charge ATM fees at local branches.

(c) Does the bank have branches available throughout the U.S.?

- As the Army requires frequent moves, it is important to consider a bank that provides service at numerous military installations where you could be stationed.

- While a local bank may be your best option, you may have to change accounts when you make a permanent change of station move.

d. **Check writing.**

(1) Managing your checkbook will be a critical factor in properly administering your personal finances.

(2) You must pay close attention to each transaction to ensure you always know your checking account balance; this ensures you have sufficient funds in the account and do not write a fraudulent check.

(3) There are several consequences for writing a bad check.

(a) Your bank and the institution to which the check was written may each assess a service charge often as much as \$30 each or more if they use a percentage system based on the amount of your check.

(b) Your reputation and credit rating will be damaged, making it difficult (and more costly) to purchase a car, home, or other items requiring a loan.

(c) You could lose check-writing privileges on post.

(d) If you bounce a check on post, your commander and 1SG will receive notification, and you may be reprimanded or punished.

e. **Eaglecash Stored Value Card.**

(1) The stored value card reduces cash/check operations for initial trainee advance, see figure 1-9 for picture.

(2) The card is used at the Army and Air Force Exchange Service sites (barber shops, clothing sales, post exchange facilities).

(3) Remaining value at expiration is returned to Soldier. Emphasis to spend full amount prior to completion of training is encouraged.

(4) Advance amounts are \$250 for males and \$300 for females.

(5) Value Card will expire 45 days from initial issue to Soldiers at the Reception Battalion.



**Figure 1-9. Eaglecash Stored Value Card**

**NOTE:** On 1 March 2009, the Defense Integrated Military Human Resources System (DIMHRS) will be the Army's Personnel and Pay (Per/Pay) System for all components Active, Army National Guard (ARNG), and the United States Army Reserve (USAR). The fielding of DIMHRS will provide Soldiers improved pay and personnel operations while creating Army operational efficiency and reduction of overall system costs. DIMHRS for personnel and pay is a fully-integrated, all service, all-Component, military personnel and pay

system that will support military personnel throughout their careers and retirement.

### **1-18. Leave and earning statement (LES)**

Your LES is a detailed pay statement issued at the end of each month that contains nine sections. Your LES can be obtained from the official MyPay Homepage at <https://mypay.dfas.mil/>.

#### **a. Entitlements deductions allotments summary.**

- (1) This column shows all of the money that you have earned:
  - (a) Base pay,
  - (b) Basic allowance for subsistence,
  - (c) Basic allowance for housing (BAH),
  - (d) Possible clothing allowance,
  - (e) Family separation pay, and
  - (f) Any other special pay.
- (2) At the bottom, you will see a total, indicating the sum of all of your entitlements for the month.

#### **b. Deductions.**

- (1) These are the deductions taken from your entitlements
  - (a) Federal taxes,
  - (b) FICA or social security,
  - (c) FICA or Medicare,
  - (d) SGLI (and family SGLI if you have requested coverage),
  - (e) Dental premiums (if you have requested coverage)
  - (f) and any other deductions.
- (2) Mid-month pay will be listed, as it is a “deduction” from your end of month entitlements.

#### **c. Allotments.**

Listed in this area are the allotments you have signed up for, to include insurance and dental allotments for your requested coverage.

#### **d. Summary.**

- (1) In the last column is your end of month pay.
- (2) The amount listed in the end of month block is the amount that will be deposited in your bank on payday.
- (3) It equals your entitlements minus your deductions and allotments.

#### **e. Leave.**

The leave row indicates the amount of leave accrued, earned, used, current balance, ETS balance, and use or lose balance.

#### **f. Taxes.**

The rows labeled FED TAXES, FICA TAXES, and STATE TAXES indicate the amount of pay deducted for taxes during the year.

#### **g. Pay data.**

- (1) In this section, pay attention to BAQ Type (it should be with dependent, without dependent(s), depending on your situation).
- (2) Make sure that the variable housing allowance zip code is correct for your or your family member(s) location.



## TRADOC Pam 600-4

(3) If the rates are incorrect and you are receiving too much money, you will have to pay it back.

### h. **Thrift savings plan.**

The Thrift Savings Plan is a Federal Government-sponsored retirement savings and investment plan. It offers the same type of savings and tax benefits that many private corporations offer their employees under "401(k)" plans. If you enroll in the thrift savings plan the rates and deductions would be listed.

### i. **Remarks.**

Examples listed in the remarks section are:

- (1) Voting information,
- (2) Pay increase announcements.,
- (3). Other announcements from the Defense Finance and Accounting Service,
- (4) Leave dates (if you have taken any during the pay period),
- (5) Allotment information,
- (6) Your bank account information,
- (7) Advance pay debt balances, and
- (8) Other information specific to your individual pay situation.

### j. **Additional Information.**

If you have questions or your LES is incorrect report it to your chain of command and go to your PAC for assistance.

## **1-19. Public affairs - Interacting with media**

The following provides guidance for Soldiers interacting with news media in the field or in the garrison environment.

a. **Know who you are talking to.** Inform your chain of command that individuals representing themselves as media are in your area. Check ID and press credentials. If they produce identification and press credentials, continue with the interview. If not, refer the individual to your chain of command and public affairs representative.

b. **Recognize your rights.** Soldiers have the right to speak or not to speak to the media; you do not have to answer all the questions; and you control the length of the interview.

c. **Meet your obligations.** Maintain operational security; exercise good judgment and professionalism at all times; inform your chain of command of the media's presence, departure, the general nature of the questions and any violation of operational security of ground rules of which you become aware.

d. **Implement these guidelines when speaking with the media.** Determine whether you want to speak to the media. Think about public affairs guidance, Soldiers media cards, or talking points you may have been given. Think before you answer; never lie or intentionally mislead the media. Speak at your level; discuss only things that you have direct responsibility for or have personal knowledge. Do not answer speculative ("what if") questions. Avoid jargon, acronyms, slang, and technical terms. Keep remarks brief and concise. Use "I"

not “we” when stating your opinion. If you do not know the answer to a question or cannot discuss it for a particular reason (for example, operational security, personal privacy, etc.), say so. Avoid using “no comment.” Assume everything you say may be printed or broadcast. Do not discuss details or future operations, unit strength, casualty numbers or names of casualties.

- (1) Determine whether you may participate in a media interview
- (2) Remember that whatever you say may be read worldwide from your hometown to the enemy command post.
- (3) Follow prior guidance put out by your chain of command.
- (4) You have the right to express your personal opinion when out of uniform. When in uniform you are an official representative of the Army.

**THIS PAGE LEFT BLANK INTENTIONALLY.**

## Chapter 2 Army Values

### 2-1. Oath of Enlistment

I, (state your name), do solemnly swear “or affirm” that I will support and defend, the Constitution of the United States against all enemies, foreign and domestic; that I will bear true faith and allegiance to the same; and that I will obey the orders of the President of the United States and the orders of the Officers appointed over me, according to regulations and the Uniform Code of Military Justice. So help me God.

### 2-2. Soldier’s Creed

I am an American Soldier.  
 I am a Warrior and a member of a team.  
 I serve the people of the United States and live the Army Values.  
 I will always place the mission first.  
 I will never accept defeat.  
 I will never quit.  
 I will never leave a fallen comrade.  
 I am disciplined, physically and mentally tough, trained, and proficient in my warrior tasks and drills.  
 I always maintain my arms, my equipment, and myself.  
 I am an expert and I am a professional.  
 I stand ready to deploy, engage, and destroy the enemies of the United States of America in close combat.  
 I am a guardian of freedom and the American way of life.  
 I am an American Soldier.

### 2-3. Soldier’s Code

I I am an American Soldier - a protector of the greatest Nation on earth - sworn to uphold the Constitution of the United States.  
 II I will treat others with dignity and respect and expect others to do the same.  
 III I will honor my Country, the Army, my unit, and my fellow Soldiers by living the Army Values.  
 IV No matter what situation I am in, I will never do anything for pleasure, profit, or personal safety, which will disgrace my uniform, my unit, or my Country.  
 V Lastly, I am proud of my Country and its flag. I want to look back and say that I am proud to have served my Country as a Soldier.

### 2-4. Soldier’s responsibilities

Soldiers in the U.S. Army take on two critical responsibilities that are uncommon to the average citizen—defend the Constitution of the U.S., and obey the orders of the President and the Officers appointed over them.

## TRADOC Pam 600-4

### a. Defend the Constitution

(1) The Constitution is the document that established our modern-day government and outlines all of our rights as American citizens.

(2) Contained within it are the very words that authorize Congress to establish an Army.

(3) Written by James Madison and ratified by Congress in 1789, the Constitution has been a living document ever since and the centerpiece of the longest-standing democratic republic in history.

(4) As Soldiers, we have sworn to defend the Constitution against all enemies, foreign and domestic.

(5) In doing so, we defend life, liberty, and the pursuit of happiness for hundreds of millions of Americans.

(6) We are “prepared to give our lives in its defense.”

### b. Obey the Orders of the President of the United States and Officers Appointed Over You

(1) The President’s greatest responsibility as Commander-in-Chief is to preserve America’s freedom.

(2) This may require him to employ American military forces and risk the lives of American Soldiers.

(3) He is the pinnacle of the Chain of Command, and it is incumbent upon every Soldier to obey his orders.

(4) This obedience goes hand-in-hand with defending the Constitution.

(5) By virtue of Congressional mandate, commissioned officers receive their authority directly from the President.

(6) Therefore, when we receive orders from the officers appointed over us, we are indirectly receiving orders from the President of the United States.

(7) In addition to these two primary responsibilities, Soldiers should also carry out their duties as dedicated and responsible citizens.

(8) Every citizen Soldier is duty-bound to vote, obey civil laws, and partake in the community on a positive level.

## 2-5. Warrior Ethos

### a. Four tenets of Warrior Ethos.

(1) A warrior always places mission first.

(2) A warrior never accepts defeat.

(3) A warrior never quits.

(4) A warrior never leaves a fallen comrade.

b. All Soldiers are warriors - prepared, trained and fully equipped for the Joint fight. Soldiers enable the Joint force by destroying the enemy in close combat, and by resolving conflict and restoring the peace.

c. Soldiers personify Warrior Ethos as part of a team, bound to each other by integrity and trust.

d. The dynamic operational environment demands that every Soldier be a warrior first and an expert in his/her individual craft to support the team.

e. Warrior Ethos is a renewed spirit being breathed into Soldiers across the force, from basic training or one station unit training (OSUT), to the Army War College, to the operational units, to self-developmental learning.

f. Warrior Ethos is the foundation for the American Soldier's total commitment to victory in peace and war. While always exemplifying Army values, Soldiers who live Warrior Ethos put the mission first, refuse to accept defeat, never quit, and never leave behind a fallen comrade. They have absolute faith in themselves and their team. They are trained and equipped to engage and destroy the enemies of the U.S. in close combat.

g. Under Warrior Ethos, a Soldier is defined as:

- (1) A warrior and a member of a team.
- (2) Trained and equipped to be flexible, adaptive, confident, and competent in warrior tasks and drills.
- (3) Proficient in required skills for his/her current duty position in unit of assignment.
- (4) Lives Warrior Ethos, grounded in Army values.
- (5) Is trained and equipped to engage and kill the enemies of the U.S. in close combat.

h. Warrior Ethos evolved as Army leaders realized the battlefields of the Global War on Terrorism and battles yet to be fought in our country's future, are asymmetrical: violent, unpredictable, and multidimensional. This complex operational environment offers no relief or respite from contact with the enemy from the lowest end of the spectrum of conflict to the highest. Soldiers are and will be under great stress - physically and psychologically - no matter what their grade, specialty, or location on the battlefield. Given this reality, all Soldiers must be prepared to close with and destroy the enemy - all Soldiers must be warriors first.

## 2-6. Army Values

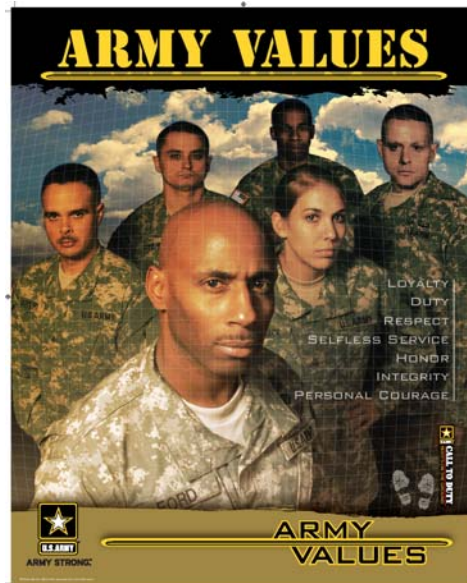

“Everywhere you look on the fields of athletic competition, in combat training, operations, and in civilian communities, Soldiers are doing what is right.”

- Julius W. Gates

Former Sergeant Major of the Army

a. **Loyalty.** Bear true faith and allegiance to the U.S. Constitution, the Army, your unit, and other Soldiers.

“Loyalty is the big thing, the greatest battle asset of all. But no man ever wins the loyalty of troops by preaching loyalty. It is given to him as he proves his possession of the other virtues.”

- Brigadier General Samuel L.A. Marshall,

Men Against Fire (1947)

(1) Bearing true faith and allegiance is a matter of believing in, and devoting yourself to something or someone. A loyal Soldier is one who supports the leadership and stands up for fellow Soldiers. Wearing the uniform of the U.S. Army is a highly visible means of expressing your loyalty. You show your loyalty to your unit by doing your share. Any time you choose one individual's actions - right or wrong - over the safety and welfare of the rest of the unit, or over your own interest and commitment, you are eroding the value of loyalty.

(2) To be loyal is to be unswerving in allegiance to the Constitution and completely faithful to the lawful government. Our absolute allegiance and faithfulness prevents us from misplacing our loyalties. Loyalty to the unit is critical for generating confidence and trust, and for developing cooperative work relationships with others.

(3) A loyal individual does the following:

(a) Respects the Constitution and laws.

(b) Puts obligations in correct order: the Constitution, the Army, the unit, and finally, self.

(c) Observes higher Headquarters priorities.

(d) Works within the system without manipulating it for personal advantage.

(e) Shows faithfulness to unit and comrades.

(f) Carries out tough orders without expressing personal criticism.

(g) Defends Soldiers against unfair treatment from outside or above.

(4) Even before the founding of the republic, America's Army has respected its subordination to its civilian political leaders. This subordination is fundamental to preserving the liberty of all Americans. You began your Army career by swearing allegiance to the Constitution, which designates the President as Commander-in-Chief.

(5) Beyond your allegiance to the Constitution, you have an obligation to be faithful to the Army, the institution and its people, and to your unit or organization. Few examples illustrate loyalty to country and institution as well as the example of General George Washington in 1782.



**General George Washington**

**General George Washington at Newburgh,  
New York (The Newburgh Conspiracy)**

Following the Army's victory at Yorktown, Virginia in 1781, the Continental Army set up camp at Newburgh, New York, to wait for peace with Great Britain. The central government formed under the Articles of Confederation proved weak and unwilling to supply the Army properly or even pay the Soldiers who had won the war for independence. After months of waiting, many officers, angry and impatient, suggested that the Army march on the seat of government in Philadelphia, Pennsylvania, and force Congress to meet the Army's demands. One colonel even suggested that General Washington become King George I.

Upon hearing this, General Washington assembled his officers and emphatically rejected the suggestion. He believed seizing power by force would destroy everything the Revolutionary War had been fought to achieve. By this action, General Washington firmly established an enduring precedent: America's armed forces are subordinate to civilian authority and serve the democratic principles that are now enshrined in the Constitution. His action demonstrated the kind of national loyalty America's Army must maintain in order to protect the freedom enjoyed by all Americans.

**b. Duty.** Fulfill your obligations.

"The essence of duty is acting in the absence of orders or direction from others, based on an inner sense of what is morally and professionally right."  
- General John A. Wickham,  
Former Army Chief of Staff

(1) Duty delineates the sum total of all laws and rules that make up our organizational, civic, and moral obligations. Our values originate with duty because, at a minimum, we expect all members of the Army to fulfill their obligations. We often expect individuals to exceed their duty, especially in ethical matters. The Nation's highest award, the Medal of Honor, imparts the notion of an individual acting "above and



## TRADOC Pam 600-4

beyond the call of duty.” Doing your duty means more than carrying out your assigned tasks.

(2) The work of the U.S. Army is a complex combination of missions, tasks, and responsibilities - all in constant motion. In addition, the work, inevitably, is a matter of building one assignment or task on work previously accomplished. Doing your duty is a very important responsibility.

(3) Duty also means being able to accomplish tasks as part of a team. You must fulfill your obligations as a part of your unit. Examples include voluntarily assuming your share of the workload, willingly serving as a member of a team, or assuming a leadership role when appropriate.

(4) You demonstrate the value of duty when you complete a task even when no one is looking, or when you resist the temptation to take "shortcuts" that might undermine the integrity of the final product. You do your duty as a Soldier every time you do something that needs to be done - without being told.

(5) An individual who expresses the value of duty will, at a minimum, do the following:

- (a) Carry out requirements of job/office.
- (b) Fulfill legal, civic, and moral obligations.
- (c) Sacrifice personal time in pursuit of excellence.

(6) Duty begins with everything required of you by law, regulation, and orders; but it includes much more than that. Professionals do their work not just to the minimum standard, but also to the very best of their ability. Soldiers and Department of the Army (DA) civilians commit to excellence in all aspects of their professional responsibility so that when the job is done they can look back and say, "I could not have given any more."

### **Captain Viola B. McConnell Duty in Korea**



CPT Viola B. McConnell was the only Army nurse on duty in Korea in July of 1950. When hostilities broke out with the North, she escorted nearly 700 American evacuees from Seoul to Japan aboard a freighter designed to accommodate only 12 passengers. CPT McConnell assessed priorities for care of

the evacuees and worked exhaustively with a medical team to care for them. Once in Japan, she requested reassignment back to Korea. After all, she had already done, CPT McConnell returned to Taejon to care for and evacuate wounded Soldiers of the 24<sup>th</sup> Infantry Division. CPT McConnell understood and fulfilled her duty to the Army and to

the Soldiers she supported in ways that went beyond her medical training. Duty is not reserved for special occasions. When a platoon sergeant tells a squad leader to inspect weapons, the squad leader has fulfilled his minimum obligation when he has checked the weapons. He has done what he was told to do. However, if the squad leader finds weapons that are not clean or serviced his sense of duty tells him to go beyond the platoon sergeant's instructions. The squad leader does his duty when he corrects the problem and ensures the weapons are up to standard.

c. **Respect.** Treat people as they should be treated.

(1) In the Soldier's Code, we pledge to "treat others with dignity and respect and expect others to do the same." Respect to a Soldier simply means treating people as they should be treated. It means giving others the same consideration we would like or expect to be given.

"The discipline which makes the Soldiers of a free country reliable in battle is not to be gained by harsh or tyrannical treatment. On the contrary, such treatment is far more likely to destroy than to make an army. It is possible to impart instruction and to give commands in such manner and such a tone of voice to inspire in the Soldier no feeling; but an intense desire to obey, while the opposite manner and tone of voice cannot fail to excite strong resentment and a desire to disobey. The one mode or the other of dealing with subordinates springs from a corresponding spirit in the breast of the commander. He who feels the respect which is due to others cannot fail to inspire in them regard for himself, while he who feels, and hence manifests, disrespect toward others, especially his inferiors, cannot fail to inspire hatred against himself."

**- Major General John M. Schofield,  
1879 address to the U.S. Corps of Cadets**

(2) The Army is one huge team, made up of hundreds of component parts. There must be connections - ground rules - so that when one Soldier approaches, works with, or talks to another, it is with immediate and unquestioned cooperation and respect. The Army mirrors our country's diversity. Each of us has something to contribute. Respect is what allows us to appreciate the best in other people. Respect is trusting that all people have done their jobs - fulfilled their duty. Self-respect is a vital ingredient within the Army value of respect that results from knowing you have dug down deep to put forth your best effort.

(3) Taking care of you physically shows your self-respect - keeping fit, not using drugs, or tobacco products (smoking, chewing, and so forth). Finally, respect for other people includes not using profanity and obscene gestures. You are now in the military. What might have been acceptable in your civilian life may not be acceptable in the Army.

(4) Respect is also an essential component for the development of disciplined, cohesive, and effective war fighting teams. In the deadly confusion of combat, Soldiers often overcome incredible odds to

## TRADOC Pam 600-4

accomplish the mission and protect the lives of their comrades. This spirit of selfless service and duty is built on a Soldier's personal trust and regard for fellow Soldiers.

(5) A leader's willingness to tolerate discrimination or harassment on any basis, or a failure to cultivate a climate of respect, eats away at this trust and erodes unit cohesion. Respect goes beyond issues of discrimination and harassment; it includes the broader issue of civility, the way people treat each other, and those they meet. It involves being sensitive to diversity and one's own behaviors that others may find insensitive, offensive, or abusive. Soldiers and DA civilians, like their leaders, treat everyone with dignity and respect.

(6) An individual who consistently expresses respect does the following:

- (a) Recognizes dignity of all.
- (b) Demonstrates consideration for others; is discreet and tactful when correcting or questioning others.
- (c) Is courteous and polite.
- (d) Demonstrates concern for safety and well-being of others.
- (e) Creates a climate of fairness.
- (f) Values diversity and is sensitive to diversity issues.
- (g) Does not take advantage of positions of authority when placed in charge of others.

### Colonel Robert Gould Shaw and the 54th Massachusetts Infantry Regiment (Civil War – 1863)



Robert Shaw was serving as a captain in the 2nd Massachusetts when Massachusetts Governor John Andrew selected him for a special assignment. Shaw was to muster and command the first regiment of African-American troops organized in a Northern state. On 18 July 1863, the regiment won undying glory by leading the bloody assault on Fort Wagner, South Carolina. In the attack, nearly half the regiment was killed, wounded, or captured. Colonel Shaw was among those who died. For his bravery in battle, Sergeant William H. Carney became the first African-American to earn the Medal of Honor. The example of steadfast courage and heroism set by the 54th Massachusetts paved the way for the enlistment of over 200,000 African-Americans in the Union Army and Navy. Colonel Shaw and the Soldiers of the 54th Massachusetts believed that a person should be able to fight for his country and be judged on his ability to Soldier rather than be judged by the color of his skin.

d. **Selfless Service.** Put the welfare of the Nation, the Army, and your subordinates before your own.

(1) In serving your country, you are doing your duty loyally, without thought of recognition or gain. The reward of selfless service

is the satisfaction of a job well done - a successful accomplishment that reflects on the Soldier and his or her unit. The greatest means of accomplishing selfless service is to dedicate yourself to the teamwork, which is the underlying strength of the Army. When thousands of Soldiers work together as a team that spectacular results arise.



“The Nation today needs men who think in terms of service to their country and not in terms of their country’s debt to them.”

- General Omar N. Bradley,  
Former General of the Army

(2) The basic building block of selfless service is the commitment of each team member to go a little further, endure a little longer, and look a little closer to see how he or she can add to the effort of the unit, platoon, or company. Selfless service is larger than just one person. With dedication to the value of selfless service, each Soldier can rightfully look back and say, "I am proud to have served my country as a Soldier."

(3) Selfless-service signifies the proper ordering of priorities. Think of it as service before self. The welfare of the Nation and the organization come before the individual. While the focus is on service to the Nation, the value also requires that the Soldier properly take care of family and self.

(4) An individual who properly demonstrates the value of selfless service does the following:

- (a) Focuses priorities on service to the Nation.
- (b) Places needs of the Army above personal gain.
- (c) Ensures that Soldiers’ needs are met before attending to personal needs.
- (d) Balances mission, family, and personal needs.
- (e) Gives credit due others and accepts blame for the team.



**CPL Hiroshi H. Miyamura Medal of Honor Recipient - 1951**

**Medal of Honor - 1951**

Corporal, U.S. Army, Company H, 7th Infantry Regiment, 3rd Infantry Division. Awarded the Medal of Honor for his actions near Taejonni, Korea, 24 and 25 April 1951. On the night of 24 April, Company H was occupying a defensive position when the enemy fanatically attacked, threatening to overrun the position. CPL Miyamura, a machine gun

squad leader, aware of the imminent danger to his men unhesitatingly jumped from his shelter wielding his bayonet in close hand-to-hand combat killing approximately 10 of the enemy. Returning to his position, he administered first aid to the wounded and directed their evacuation. As another savage assault hit the line, he manned his machinegun and delivered withering fire until his ammunition was expended. He ordered the squad to withdraw while he stayed behind to render the gun inoperative. He then bayoneted his way through infiltrated enemy Soldiers to a second gun emplacement and assisted in its operation.

When the intensity of the attack necessitated the withdrawal of the company, CPL Miyamura ordered his men to fall back while he remained to cover their movement. He killed more than 50 of the enemy before his ammunition ran out and he was severely wounded. He maintained his magnificent stand despite his painful wounds, continuing to repel the attack until his position was overrun. When last seen he was fighting ferociously against an overwhelming number of enemy Soldiers. CPL Miyamura's indomitable heroism and consummate devotion to duty reflect the utmost glory on himself and uphold the illustrious traditions of the military service.

e. **Honor.** Live up to all the Army values.

(1) When we talk about "living up to" something, we mean being worthy of it. We must make choices, decisions, and actions based on the Army core values. Nowhere in our values training does it become more important to emphasize the difference between "knowing" the values and "living" them, than when we discuss the value of honor. Honor is a matter of carrying out, acting, and living the values of respect, duty, loyalty, selfless service, integrity, and personal courage in everything you do.

"What is life without honor? Degradation is worse than death."

**- LTG Thomas J. "Stonewall" Jackson**

(2) Noticing a situation and deciding to take action to assist another involves respect, duty, and honor. It was a matter of honor that

Soldiers, at great risk to themselves, distributed food in Somalia and kept the peace in Bosnia, while managing to protect the communities. There are hundreds of examples of Soldiers who have distinguished themselves with honorable actions and lives. The Nation's highest military award is named "The Medal of Honor." This award goes to Soldiers who make honor a matter of daily living - Soldiers who develop a habit of being honorable, and solidify that habit with every value choice they make.

- (3) An individual with honor does the following:
- (a) Adheres to a public code of professional Army values.
  - (b) Identifies with the public code of professional Army values.

**MSG Gary Gordon and SFC Randall Shughart  
Mogadishu, Somalia - 1993**

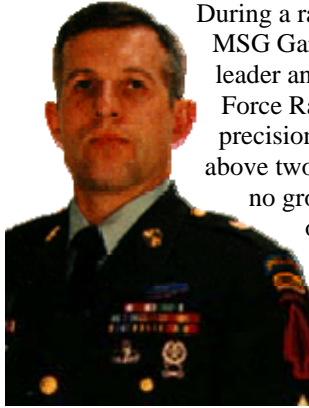

During a raid in Mogadishu in October 1993, MSG Gary Gordon and SFC Randall Shughart, leader and member of a sniper team with Task Force Ranger in Somalia, were providing precision and suppressive fires from helicopters above two helicopter crash sites. Learning that no ground forces were available to rescue one of the downed aircrews, and aware that a growing number of enemy were closing in on the site, MSG Gordon and SFC Shughart volunteered to be inserted to protect their critically wounded comrades. Their initial request was turned

down because of the danger of the situation. They asked a second time; permission was denied. Only after their third request were they inserted.

MSG Gordon and SFC Shughart were inserted one hundred meters south of the downed chopper. Armed only with their personal weapons, the two NCOs fought their way to the downed fliers through intense small arms fire, a maze of shanties and shacks, and the enemy converging on the site. After MSG Gordon and SFC Shughart pulled the wounded from the wreckage, they established a perimeter, put themselves in the most dangerous position, and fought off a series of attacks. Before being fatally wounded, the two NCOs continued to protect their comrades until they depleted their ammunition. Their actions saved the life of an Army pilot.

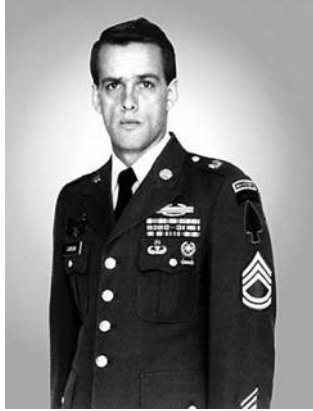

No one will ever know what was running through the minds of MSG Gordon and SFC Shughart as they left the comparative safety of their helicopter to go to the aid of the downed aircrew. The two NCOs knew there was no ground rescue force available, and they certainly knew there was no going back to their helicopter. They may have suspected that things would turn out as they did; nonetheless, they did what they believed to be the right thing.

They acted based on Army values, which they had clearly made their own: loyalty to their fellow Soldiers; the duty to stand by them, regardless of the circumstances; the personal courage to act, even in the face of great danger; selfless service, the willingness to give their all. MSG Gary I. Gordon and SFC Randall D. Shughart lived Army values to the end; they were posthumously awarded Medals of Honor.

f. **Integrity.** Do what is right, legally and morally.

“The American people rightly look to their military leaders not only to be skilled in the technical aspects of the profession of arms, but also to be men of integrity.”

**- General J. Lawton Collins,  
Former Army Chief of Staff**

(1) When we say that someone has integrity, we mean that person respects the rules of an organization, the country, and life. Such persons can be counted on to do the right thing, live honestly, and relate to others without playing games or having false agendas. Integrity is a quality you develop by adhering to moral principles.

(2) It requires that we do and say nothing that deceives others. As your integrity grows, so does the trust others place in you. It's integrity that requires us to pay our debts on time, turn in items that someone else has lost, and follow rules as laid out in the law or in the code of human ethics and morality.

(3) The Soldier's Code says, "No matter what situation I am in, I will never do anything for pleasure, profit, or personal safety that will disgrace my uniform, my unit, or my country." The more choices you make based on integrity, the more this highly prized value will affect your relationships with family and friends, and, finally, your fundamental acceptance of yourself.

(4) A Soldier displays integrity when he or she:

(a) Always acts according to what he or she knows to be right, even at personal cost.

- (b) Possesses a high standard of moral values and principles.
- (c) Shows good moral judgment and demonstrates consistent moral behavior.
- (d) Avoids the wrong and stands up for what is right.
- (e) Shows candor and fairness in evaluating subordinates' work.
- (f) Shows consistency between words and deeds.
- (g) Uses the authority and power that comes with grade to work for Soldiers and mission accomplishment instead of personal or private gain.
- (h) Puts being right ahead of being popular or easy.
- (i) Abides by principles.



**SSG Roy P. Benavidez**  
**Detachment B-56, 5th Special Forces Group, Republic of**  
**Vietnam West of Loc Ninh - 1968**



Master Sergeant (then Staff Sergeant) Roy P. Benavidez, U.S. Army, distinguished himself by a series of daring and extremely valorous actions while assigned to Detachment B56, 5th Special Forces Group (Airborne), 1st Special Forces, Republic of Vietnam.

On the morning of 2 May 1968, helicopters inserted a 12-man Special Forces Reconnaissance Team in a dense jungle area west of Loc Ninh, Vietnam to gather intelligence information about confirmed large-scale enemy activity.

This area was controlled and routinely patrolled by the North Vietnamese Army. After a short period of time on the ground, the team met heavy enemy resistance and requested emergency extraction. Three helicopters attempted extraction, but were unable to land due to intense enemy small arms and anti-aircraft fire. Sergeant Benavidez was at the Forward Operating Base in Loc Ninh monitoring the operation by radio when these helicopters returned to off-load wounded crewmembers and assess aircraft damage. Sergeant Benavidez voluntarily boarded a returning aircraft to assist in another extraction attempt. Realizing that all the team members were either dead or wounded and unable to move to the pickup zone, he directed the aircraft to a nearby clearing where he jumped from the hovering helicopter, and ran approximately 75 meters under withering small arms fire to the crippled team. Prior to reaching the team's position, he was wounded in his right leg, face, and head. Despite these painful injuries, he took charge, repositioning the team members and directing their fire to facilitate the landing of an extraction aircraft, and the loading of wounded and dead team members. He then threw smoke canisters to direct the aircraft to the team's position. Despite his severe wounds and the intense enemy fire, he carried and dragged half of the wounded team members to the awaiting aircraft. He then provided protective fire by running alongside the aircraft as it moved to pick up the remaining team members.

As the enemy's fire intensified, he hurried to recover the body of the dead team leader and some classified documents. When he reached the leader's body, Sergeant Benavidez was severely wounded by small arms fire in the abdomen and grenade fragments in his back. At nearly the same moment, the aircraft pilot was mortally wounded, and his helicopter crashed. Although in extremely critical condition due to his multiple wounds, Sergeant Benavidez

secured the classified documents and made his way back to the wreckage where he aided the wounded out of the overturned aircraft. He then gathered the stunned survivors into a defensive perimeter. Under increasing enemy automatic weapons and grenade fire, he moved around the perimeter distributing water and ammunition to his weary men, re-instilling in them a will to live and fight.

Facing a buildup of enemy opposition with a beleaguered team, Sergeant Benavidez mustered his strength, began calling in tactical air strikes and directed the fire from supporting gun ships to suppress the enemy's fire and to permit another extraction attempt. He was wounded again in his thigh by small arms fire while administering first aid to a wounded team member just before another extraction helicopter was able to land. His indomitable spirit kept him going as he began to ferry his comrades to the craft. On his second trip with the wounded, he received additional wounds to his head and arms before killing his adversary. He then continued under devastating fire to carry the wounded to the helicopter.

Upon reaching the aircraft, he spotted and killed two enemy Soldiers who were rushing the craft from an angle that prevented the aircraft door gunner from firing upon them. With little strength remaining, he made one last perimeter trip to bring in the remaining wounded and to ensure that all classified material had been collected or destroyed. Only then, in extremely serious condition from numerous wounds and loss of blood, did he allow himself to be pulled into the extraction aircraft.

Sergeant Benavidez' gallant choice to voluntarily join his comrades who were in critical straits, to expose himself constantly to withering enemy fire, and his refusal to be stopped despite numerous severe wounds, saved the lives of at least eight men. His fearless personal leadership, tenacious devotion to duty, and extremely valorous actions in the face of overwhelming odds were in keeping with the highest traditions of the military service, and reflect the utmost credit on him and the U.S. Army.

g. **Personal courage.** Face fear, danger, or adversity (physical or moral).

“The concept of professional courage does not always mean being tough as nails either. It also suggests a willingness to listen to the Soldier’s problems, to go to bat for them in a tough situation, and it means knowing just how far they can go. It also means being willing to tell the boss when he’s wrong.”

- CSM William Connelly,  
Former Sergeant Major of the Army

(1) Personal courage includes the notion of taking responsibility for decisions and actions. Additionally, courage involves the ability to perform critical self-assessment, to confront new ideas, and to change.

## TRADOC Pam 600-4

Leaders must make decisions that involve risk and often must take a stand in the face of ambiguity or adversity. Taking risks pertains to the battlefield in war, but more frequently occurs with your boss in peace.

(2) A courageous Soldier does the following:

(a) Controls fear in physical and moral contexts.

(b) Takes responsibility for decisions and actions.

(c) Accepts responsibility for his own mistakes and shortcomings.

(d) Confronts problems directly and takes action based on what he believes is right, regardless of what others may think.

(e) Speaks up for what he believes is important and then is gracious whether his ideas are accepted or rejected.

(f) Reports on successes and failures with equal candor.

(g) Puts himself on the line to deal with important problems.

(h) Challenges others to make tough decisions.

(i) Always shares mistakes if it will help the team improve.

(3) Personal courage has long been associated with our Army.

Accounts of the dangers and hardships that Soldiers face are legendary. Personal courage is not the absence of fear. Rather, it is taking positive action in spite of fear.

(a) Personal courage takes two forms: physical, and moral.

(b) Physical courage means overcoming fears of bodily harm and doing your duty. It is the bravery that allows a Soldier to take risks in combat in spite of any fear of wounds or death. Physical courage is what propels the Soldier at Airborne School out the aircraft door. It is what allows an Infantryman to assault a bunker to save his buddies. With physical courage, it is a matter of enduring physical duress, and at times, risking personal safety.

(c) In contrast, moral courage is the willingness to stand firm on your values, principles, and convictions, even when threatened. Moral courage is sometimes overlooked, both in discussions of personal courage and in routine, daily activities. Moral courage often expresses itself as candor. Candor means being frank, honest, and sincere with others while keeping your words free from bias, prejudice, or malice.

(4) When considering personal courage, either physical or moral, there is one important point to be made. Nowhere does the value say that fear must disappear - that you should not feel fear. Some great instances of courage are those carried out by Soldiers who have never seen a battlefield. You can build up your personal courage daily by standing up for and acting upon the things that you know are right.

**SSG Clifford C. Sims**  
**Company D, 2d Battalion (Airborne), 501st Infantry,**  
**101st Airborne Division**  
**Near Hue, Republic of Vietnam - 1968**



Company D was assaulting a heavily fortified enemy position concealed within a dense wooded area when it encountered strong enemy defensive fire. Once within the wood line, SSG Sims led his squad in a furious attack against an enemy force, which had pinned down the 1st Platoon and threatened to overrun it. His skillful leadership provided the platoon with freedom of movement and enabled it to regain the initiative. SSG Sims was then ordered to move his squad to a position where he could provide covering fire for the company command group and to link up with the 3rd Platoon, which was under heavy enemy pressure. After moving no more than 30 meters, SSG Sims noticed that a brick structure in which ammunition was stocked was on fire. Realizing the danger, SSG Sims took immediate action to move his squad from this position. In the process of leaving the area, two members of his squad were injured by the subsequent explosion of the ammunition. SSG Sims' prompt actions undoubtedly prevented more serious casualties from occurring.

While continuing through the dense woods amid heavy enemy fire, SSG Sims and his squad approached a bunker when they heard the noise of a concealed booby trap being triggered immediately to their front. SSG Sims warned his comrades of the danger and unhesitatingly hurled himself upon the device as it exploded, taking the full impact of the blast. To protect his fellow Soldiers, SSG Sims willingly sacrificed his life. His extraordinary heroism at the cost of his life is in keeping with the highest traditions of the military service and reflects great credit upon himself and the U.S. Army.

**SFC Paul R. Smith**  
**Bravo Company, 11th Engineer Battalion, 1st Brigade Combat**  
**Team, 3rd Infantry Division, Near Baghdad, Iraq - 2003**



**“Above and beyond the call.”** A Bravo Company Task Force was engaged in the construction of a prisoner of war holding area when it was violently attacked by a company-sized enemy force near the International Airport in Baghdad, Iraq on 4 April 2003. Sergeant First Class Smith realizing the vulnerability of over 100 fellow Soldiers, quickly organized a hasty defense consisting of two platoons

of Soldiers, one Bradley Fighting Vehicle and three armored personnel carriers. As the fight developed, Sergeant First Class Smith braved hostile enemy fire to personally engage the enemy with hand grenades and anti-tank weapons, and organized the evacuation of three wounded Soldiers from an armored personnel carrier struck by a rocket propelled grenade and a 60mm mortar round. Fearing the enemy would overrun their defenses, Sergeant First Class Smith moved under withering enemy fire to man a .50 caliber machine gun mounted on a damaged armored personnel carrier. In total disregard for his own life, he maintained his exposed position in order to engage the attacking enemy force. During this action, he was mortally wounded. His courageous actions helped defeat the enemy attack, and resulted in as many as 50 enemy Soldiers killed, while allowing the safe withdrawal of numerous wounded Soldiers. Sergeant First Class Smith’s extraordinary heroism and uncommon valor are in keeping with the highest traditions of the military service and reflect great credit upon himself, the 3rd Infantry Division and the U.S. Army.

**2-7. Code of Conduct**

**I** I am an American, fighting in the forces which guard my country and our way of life. I am prepared to give my life in their defense.

**II** I will never surrender of my own free will. If in command, I will never surrender the members of my command while they still have the means to resist.

**III** If I am captured, I will continue to resist by all means available. I will make every effort to escape and aid others to escape. I will accept neither parole nor special favors from the enemy.

**IV** If I become a prisoner of war, I will keep faith with my fellow prisoners. I will give no information or take part in any action, which might be harmful to my comrades. If I am senior, I will take command. If not, I will obey the lawful orders of those appointed over me and will back them up in every way.

**V** When questioned, should I become a prisoner of war, I am required to give name, rank, service number, and date of birth. I will evade answering further questions to the utmost of my ability. I will make no oral or written statements disloyal to my country and its allies or harmful to their cause.

**VI** I will never forget that I am an American, fighting for freedom, responsible for my actions, and dedicated to the principles which made my country free. I will trust in my God and in the United States of America.

**2-8. Outcomes based training**

a. The five designated outcomes below are what each Soldier should strive to be. Training emphasizes setting clear standards that are observable and measurable. Your chain of command will use these exact outcomes, or similar ones, to develop you in all Soldier attributes and skill areas. Throughout your initial entry training (IET), leaders and drill sergeants will analyze and evaluate your performance constantly in order to determine if you are obtaining the desired outcomes. You must clarify and capture key points during formal and informal feedback sessions, by asking questions, in order to improve daily throughout your training.

b. As you progress, you must strive to master critical combat skills and display an adequate level of proficiency in Soldier skills. This training will improve your survivability on the battlefield while providing you with a belief in your own abilities. The skills mastered in IET may be the last formal training you receive before engaging the enemy, so make use of every opportunity to hone your skills. You must also demonstrate daily development in the intangibles such as self-discipline, proud team member, and mission accomplishment. These strong attributes will serve you well not only in IET, but throughout your entire Army career.

TRADOC Pam 600-4

c. Regardless of your military occupational specialty (MOS), you must be ready to take up your weapon and fight when engaged. You may convoy, pull guard, patrol streets, or attack an enemy position--all requiring you to kill the enemy if necessary. Your IET chain of command wants you to be able to contribute immediately to your first unit of assignment and to the successful accomplishment of its mission. All of this means that you must be ready to survive and to fight on the battlefield at the end of advanced individual training (AIT) or unit training. Your leaders will demonstrate actions and attitudes during the cycle, which in turn will allow you to replicate and internalize the attributes that will lead to success. Absorb as much knowledge as you can in training; it will keep you alive in the future.

Every Soldier should strive for the following:

- (1) Is a proud team member possessing the character and commitment to live the Army Values and Warrior Ethos.
- (2) Is confident, adaptable, mentally agile, and accountable for own actions
- (3) Is physically, mentally, spiritually, and emotionally ready to fight as a ground combatant
- (4) Is a master of critical combat skills and proficient in basic Soldier skills
- (5) Is self-disciplined, willing, and an adaptive thinker capable of solving problems commensurate with position and experience

**THIS PAGE LEFT BLANK INTENTIONALLY.**



**Chapter 3**

**Standards of Conduct**

**3-1. The Uniform Code of Military Justice (UCMJ)**

a. Military discipline is founded upon self-discipline, respect for authority, and the embracing of the professional Army ethic with its supporting individual values. Military discipline is developed through individual and group training to create a mental attitude that will result in proper conduct and prompt obedience to lawful military authority. There are three basic rules:

(1) Don't break the rules. (What are the rules? Example - UCMJ, regulations.)

(2) Take responsibility for your actions.

(3) Keep your hands to yourself.

b. While military discipline is the result of effective training, it affects every aspect of military life. It is a trait found in individuals and units that are manifested by:

(1) Unit cohesion, bonding, and a spirit of teamwork.

(2) Smartness of appearance and action.

(3) Cleanliness and maintenance of dress, equipment, and quarters.

(4) Respect to seniors and mutual respect between senior and subordinate personnel.

(5) Prompt and willing execution of both the letter, and the spirit of the legal orders of their lawful commanders.

(6) Fairness, justice, and equity for all Soldiers, regardless of race, religion, color, gender, or national origin.

c. The UCMJ applies to active duty Soldiers:

(1) 24 hours a day, 7 days a week.

(2) Anywhere you are in the world.

(3) After discharge, if discharge was obtained fraudulently.

(4) After active duty status is terminated (for Reserve and National Guard Soldiers).

d. In other words, it is your duty to abide by the laws and regulations governed by the UCMJ, 24 hours a day, 7 days a week, for as long as you are in the Army. All persons in the military service are required to strictly obey and promptly execute the legal orders of their lawful seniors. Laws and regulations are part of everyday life. The UCMJ gives us judicial authority, which is essential to the Army's ability in accomplishing its military mission. The UCMJ is the statute that prescribes criminal law for Soldiers.

e. The UCMJ authorizes non-judicial punishment by commanders and judicial punishment by courts-martial (military courts). It also provides for the punishment of strictly military offenses. Military offenses are those not common in civilian law. Examples include failure to repair, absence without leave, disrespect to NCOs and commissioned officers, and disobedience of orders.

f. The principle that an accused is innocent until proven guilty applies to both non-judicial punishment and courts-martial. You have the right to be informed of any charges against you, as well as the names of accusers and known witnesses.

g. You also have:

(1) The right to remain silent. You do not have to say anything that could be used to convict you. Anything you say can be used as evidence against you.

(2) The right to a military lawyer, unless you wish to hire a civilian lawyer at your own expense.

(3) Protection against double jeopardy. If found innocent by courts-martial, you cannot be tried again by a courts-martial for the same crime.

(4) The right to sentence review. Higher authority automatically reviews a conviction received in the military. The sentence cannot be increased but may be left as it is or decreased.

(5) The right to a speedy public trial.

(6) The right to call witnesses favorable to you.

(7) The right to an interpreter if you do not fully understand the English language.

(8) The right, if you are an enlisted person, to have at least one-third enlisted court members.

(9) The right to be tried by a military judge alone rather than by a courts-martial panel, unless the case is tried as a capital offense. If the Soldier does not elect trial by military judge, a trial with members will automatically be afforded the Soldier.

(10) The right to trial by courts-martial. You may refuse Article 15 punishment and demand trial by courts-martial.

### **3-2. UCMJ: non-judicial punishment**

a. Under the provisions of the UCMJ, Article 15, commanding officers may impose non-judicial punishment upon Soldiers who commit minor offenses within their units. The purpose of non-judicial punishment is to train, correct, and reform. It also promotes positive behavior changes in Soldiers without the stigma of a courts-martial conviction.

b. If you are the accused Soldier, you have the option of either demanding trial by courts-martial or accepting non-judicial punishment.

c. Once your commanding officer has passed judgment and sentenced you, if you feel the punishment awarded to you is unjust or disproportionate to the offense, you may appeal all or part of your sentence to the next higher authority. The appeal authority may set aside, decrease, suspend, or let stand any portion or the entire original sentence. However, the authority cannot in any way increase the original sentence.

d. **Article 15.** Article 15 of the UCMJ is a form of non-judicial punishment that can be imposed by a commanding officer for a relatively minor offense. An Article 15 can be imposed upon any Soldier who does not demand a court-martial. There are two types of Article 15 proceedings: summarized, and formal.

(1) Summarized proceedings may be used for very minor misconduct. The punishment should not exceed an oral reprimand, extra duty, restriction for 14 days, or any combination of these punishments.

(2) Formal proceedings begin with the initial notification, and end with the appeals process. The maximum punishments for a Soldier grade E4 and below by a field grade commander include a reprimand, extra duty for 45 days, restriction for 60 days, correctional custody for 30 days, loss of ½ pay per month for 2 months, grade reduction to one or more lower grades, or a combination of any of these punishments.

### **3-3. UCMJ: courts-martial**

a. There are three types of courts-martial: **summary, special, and general.** Trials by courts-martial are the military equivalents of trials by judges and juries. The differences among the three are based on their composition, level of authority, and severity of punishments authorized.

(1) **Summary courts-martial.** This court is composed of a commissioned officer on active duty with the grade of captain or above. The purpose of the summary courts-martial is to make thorough and impartial inquiries into minor offenses and to make sure that justice is done, with the interests of both the government and the accused being safeguarded.

(a) Only enlisted personnel may be tried by summary courts-martial. Anyone subject to summary courts-martial may refuse to be tried by summary courts-martial.

(b) Whether an offense is minor depends on several factors, including the nature and circumstances of the offense. Also considered is the age, grade, duty assignment, record, and experience of the accused.

(c) The maximum punishment that can be given by summary courts-martial to a Soldier pay grade E4 or below is:

- Confinement at hard labor for one month.
- Forfeiture of two-thirds of a month's pay for one month.
- Reduction to the lowest enlisted grade.

(2) **Special courts-martial.** This court consists of a military judge and not less than three panel members when required. It is held for relatively serious offenses.

(a) The maximum punishment that can be given by a special courts-martial is:

- Confinement at hard labor for six months.

- Forfeiture of two-thirds of a month's pay for six months.
- Reduction to the lowest enlisted grade.

(b) Some special courts-martial are empowered to rule on a Bad Conduct Discharge. This punitive discharge deprives a Soldier of many veterans' benefits.

(3) General **courts-martial**. This court consists of a military judge and not less than five panel members when required. It is held for serious offenses. A general courts-martial may impose any authorized punishment including the death penalty in certain cases.

#### **3-4. UCMJ: punitive articles**

a. The following list contains the descriptive title and general provisions of selected punitive articles of the UCMJ that commonly occur in the training environment:

b. **ARTICLE 83: Fraudulent Enlistment, Appointment, or Separation.** Article can apply to any Soldier who-

(1) Procures his own enlistment or appointment in the armed forces by knowingly false representation or deliberate concealment as to his qualifications for that enlistment or appointment and receives pay and allowances there under.

(2) Procures his own separation from the armed forces by knowingly false representation or deliberate concealment as to his eligibility for that separation; shall be punished as a courts-martial may direct.

c. **ARTICLE 86: Absent Without Leave.** Article and any punishment a courts-martial may direct can apply to any Soldier who, without authority-

(1) Fails to go to his appointed place of duty at the time prescribed.

(2). Absents himself or remains absent from his unit, organization, or place of duty at which he is required to be at the time prescribed.

d. **ARTICLE 89: Disrespect Toward A Superior Commissioned Officer.** Article and any punishment a courts-martial may direct can apply to any Soldier who behaves with disrespect toward his superior commissioned officer. Disrespectful behavior is that which detracts from the respect due the authority of a superior commissioned officer or NCO. Disrespectful behavior includes the following acts or language:

(1) Abusive epithets or other contemptuous or denunciatory language.

(2) Neglecting the customary salute.

(3) Showing marked disdain, indifference, insolence, impertinence, undue familiarity, or other rudeness in the presence of the superior.

e. **ARTICLE 90: Assaulting or Willfully Disobeying Superior Commissioned Officer.** Article and any punishment a courts-martial may direct can apply to any Soldier who-

TRADOC Pam 600-4

(1) Strikes his superior commissioned officer or draws or lifts up any weapon or offers any violence against him while he is in the execution of his office.

(2) Willfully disobeys a lawful command of his superior commissioned officer. If the offense is committed in time of war, a sentence of death could be administered. If the offense is committed when not at war, punishment other than death could result.

f. **ARTICLE 91: Insubordinate Conduct Toward Warrant Officer, NCO, or Petty Officer.** Article and any punishment a courts-martial may direct can apply to any Soldier who-

(1) Strikes or assaults a warrant officer, NCO, or petty officer, while that officer is in the execution of his office.

(2) Willfully disobeys the lawful order of a warrant officer, NCO, or petty officer.

(3) Treats with contempt or is disrespectful in language or deportment toward a warrant officer, NCO, or petty officer while that officer is in the execution of his office

g. **ARTICLE 92: Failure to Obey Orders.** Article and any punishment a courts-martial may direct can apply to any Soldier who-

(1) Violates or fails to obey any lawful general order or regulation.

(2) Disobeys a lawful order issued by a member of the armed forces.

(3) Is derelict in the performance of his duties; shall be punished as a court-martial may direct.

h. **ARTICLE 107: False Official Statements.**

(1) Any person subject to this chapter who, with intent to deceive, signs any false record, return, regulation, order, or other official document, knowing it to be false, or makes any other false official statement knowing it to be false, shall be punished as a court-martial may direct.

(2) Official documents and official statements include all documents and statements made in the line of duty.

i. **ARTICLE 115: Malingering.** Article and any punishment a courts-martial may direct can apply to any Soldier who for the purpose of avoiding work, duty, or service-

(1) Feigns illness, physical disablement, mental lapse or detriment.

(2) Intentionally inflicts self-injury.

j. **ARTICLE 121: Larceny and Wrongful Appropriation.** Article and any punishment a courts-martial may direct can apply to any Soldier who wrongfully takes, obtains, or withholds, by any means, from the possession of the owner or of any other person any money, personal property, or article of value of any kind.

(1) A verdict of larceny will result if theft was committed to permanently deprive or defraud another person of the use and benefit of property; and to appropriate it for his own use or the use of any person other than the owner.

(2) A verdict of wrongful appropriation will result if an item(s) was taken with intent to temporarily deprive or defraud another person of

the use and benefit of property; and to appropriate it to his own use or the use of any person other than the owner.

k. **ARTICLE 128: Assault.** Article and any punishment a courts-martial may direct can apply to any Soldier who-

(1) Attempts or offers with unlawful force or violence to do bodily harm to another person, whether or not the attempt or offer is consummated.

(2) Commits an assault with a dangerous weapon or other means or force likely to produce death or grievous bodily harm.

(3) A verdict of aggravated assault will result if an assault was committed with the intention of inflicting grievous bodily harm with or without a weapon.

l. **ARTICLE 134: General Article.** Article applies to-

(1) All disorders and neglects to the prejudice of good order and discipline in the armed forces.

(2) All conduct of a nature to bring discredit upon the armed forces.

(3) Crimes and offenses not capital, of which persons subject to this chapter may be guilty, shall be taken cognizance of by a general, special, or summary courts-martial. Soldiers in violation shall be punished according to the nature and degree of the offense.

### 3-5. UCMJ: forms of punishment

a. The following are forms of punishment that may be imposed for violations of the UCMJ. All forms of punishment are subject to restrictions specified in the UCMJ. The UCMJ provides limitations of sentences based on the following factors: The nature of the crime; the form of adjudication (non-judicial punishment or courts-martial); the position or grade of the individual assigning the punishment; the type of courts-martial that convicted the Soldier.

(1) Reprimand. The convening authority of a courts-martial or commanding officer may punish a Soldier by censure (to condemn as wrong). A reprimand is a severe form of censure that adversely reflects upon the conduct of the person addressed. A courts-martial shall not specify the terms or wording of a reprimand. A reprimand, if approved, shall be issued, in writing, by the convening authority. A reprimand adjudged by a courts-martial is a punitive censure.

(2) Forfeiture **of pay and allowances.** Deprives the individual accused of all or a specific amount of money to be accrued (earned in the future) as a result of service in the armed forces of the U.S. Unless a total forfeiture is adjudged, a sentence of forfeiture shall state the exact amount of money to be forfeited each month in whole dollars, and the number of months the forfeitures will last.

(3) Fines. Makes the accused immediately liable to the U.S. for the entire amount of money specified in the sentence. A fine may only be adjudged by a courts-martial, and may be adjudged, instead of, or in addition to, forfeiture. However, a fine is normally used only as a

TRADOC Pam 600-4

sentence in cases where the accused was unjustly enriched as a result of the convicted offense.

(4) **Reduction in pay grade.** Except as provided in R.C.M. 1301(d). A courts-martial may sentence an enlisted member to be reduced to the lowest or any intermediate pay grade.

(5) **Restriction to specified limits.** Deprives the accused of normal liberty privileges. The sentence will specify the physical and geographic locations in which the individual is allowed, how long the restriction shall last, and when that individual must be present at specific locations.

(6) **Hard labor without confinement.** Is performed in addition to other regular duties and does not excuse or relieve a person from performing regular duties. Ordinarily, the immediate commander of the accused will designate the amount and character of the labor to be performed.

(7) **Confinement.** The place of confinement shall not be designated by the courts-martial. A courts-martial shall not adjudge a sentence to solitary confinement or to confinement without hard labor. The authority executing a sentence to confinement may require hard labor whether or not the words "at hard labor" are included in the sentence.

(8) **Punitive separation.** A courts-martial may not adjudge an administrative separation from the service. There are three types of punitive separation.

(a) **Dismissal.** Applies only to commissioned officers, commissioned warrant officers, cadets, and midshipmen and may be adjudged only by general courts-martial. Regardless of the maximum punishment specified for an offense in part IV of the Manual for Courts Martial, a dismissal may be adjudged for any offense of which a commissioned officer, commissioned warrant officer, cadet, or midshipman has been found guilty of.

(b) **Dishonorable discharge.** Applies only to enlisted persons and warrant officers, who are not commissioned, and may be adjudged only by general courts-martial. A dishonorable discharge should be reserved for those separated under conditions of dishonor following conviction of offenses recognized in civilian jurisdictions as felonies, or of offenses of a military nature requiring severe punishment.

(c) **Bad conduct discharge.** Applies only to enlisted persons. May be adjudged by a general courts-martial or by a special courts-martial that has met the requirements of R.C.M. 201(F)(2)(B). A bad-conduct discharge is less severe than a dishonorable discharge. It is designed as a punishment for bad-conduct rather than as a punishment for serious offenses of either a civilian or military nature. It is also appropriate for an accused who has been convicted repeatedly of minor offenses and whose punitive separation appears to be necessary.

(9) **Death.**

**3-6. Army Equal Opportunity (EO) Program and policy**

a. The EO program ensures an Army wide, concentrated effort to maximize human potential and to ensure fair treatment for all persons based solely on merit, fitness, and capability in support of readiness. The EO philosophy is based on fairness, justice, and equity.

b. The Army's EO program emphasizes fair and equal treatment. It provides equal opportunity and treatment for military personnel, and civilian employees without regard to race, color, religion, gender, or national origin. This policy:

(1) Applies on and off post,

(2) Extends to Soldiers, civilian employees, and family members, and

(3) Includes working, living, and recreational environments.

c. The EO complaints processing system addresses grievances that allege unlawful discrimination or unfair treatment on the basis of race, national origin, color, gender, religious affiliation, or sexual harassment. Attempts should always be made to solve the problem at the lowest possible level within an organization.

d. If a complaint is submitted, it will be investigated. Those personnel found in violation of the EO Policy are subject to punishment under the UCMJ.

e. **EO complaint process.** Individuals are encouraged to attempt resolution of any complaints by confronting an alleged offender, or by informing other appropriate officials about the offensive behavior or unfair treatment.

(1) Individuals are responsible to advise their chain of command on the specifics of any discrimination or sexual harassment so appropriate action can be taken. Personnel must submit only legitimate complaints, and should exercise caution against frivolous or reckless allegations.

(2) The Army has two types of EO complaints within its EO complaint process: informal, and formal.

(a) **Informal complaints.** An informal complaint is any complaint that a Soldier, family member or DA civilian does not wish to file in writing. Informal complaints may be resolved by the complainant directly with the assistance of another unit member, the commander, or another person in the complainant's chain of command. Typically, those issues that may be taken care of informally can be resolved through discussion, problem identification, and clarification of the issues. An informal complaint is not subject to time suspense, nor is it reportable.

(b) **Formal complaints.** A formal complaint is one that a Soldier, family member, or DA civilian files in writing and swears to the accuracy of the information. DA Form 7279-R, Equal Opportunity Complaint Form can be obtained at the unit or higher headquarters level. Formal complaints require specific actions, are subject to timelines, and require documentation of actions taken.



(c) **Alternative agencies.** Although handling EO complaints through the chain of command is strongly encouraged, this is not the only channel. Should the Soldier feel uncomfortable in filing a complaint with the chain of command, or should the complaint be against a member of the chain of command, there are a number of alternative agencies through which a complaint can be made. The following agencies are frequently used:

- EO adviser.
- Chaplain.
- Provost Marshal.
- Staff Judge Advocate.
- Housing Referral Office.
- Inspector General.
- EO Hotline.

(d) **Right to appeal.** If a complainant perceives an investigation failed to reveal all relevant facts, or if actions taken on their behalf are perceived as insufficient, he or she has the right to appeal to the next higher commander. The complainant may not appeal the action taken against the perpetrator, if any is taken.

### **3-7. Military Whistleblowers Protection Act (MWPA)**

DA personnel are prohibited from taking acts of reprisal against any Soldier for making or preparing to make a protected communication.

a. A protected communication is any lawful communication to a member of Congress; an inspector general (IG); a member of a DoD audit, inspection, investigation or law enforcement organization; or any other person or organization designated to receive such communication, regarding information which the Soldier reasonably believes evidences a violation of law or regulation prohibiting sexual harassment or unlawful discrimination, gross mismanagement, a gross waste of funds or other resources, an abuse of authority, or a substantial and specific danger to public health or safety.

b. Reprisal is the taking or threat to take an unfavorable personnel action, or the withholding or threat to withhold a favorable personnel action, in reprisal against any Soldier for making or preparing a protected communication.

c. The chain of command will ensure complainants are protected from reprisal or retaliation for filing equal opportunity complaints. Should Soldiers be threatened with such an act, or should an act of reprisal occur, they must report these circumstances to the DoD IG.

### **3-8. Army policy on relationships between Soldiers**

a. The Army has historically relied upon custom and tradition to define the bounds of acceptable personal relationships between Soldiers of different rank. Soldier relationships have always been judged with reference to customs and traditions of the service.

b. Relationships between Soldiers of different rank are prohibited if they-

- (1) Compromise, or appear to compromise, the integrity of supervisory authority or the chain of command.
- (2) Cause actual or perceived partiality or unfairness.
- (3) Involve or appear to involve the improper use of grade or position for personal gain.
- (4) Are or are perceived to be exploitive or coercive in nature.
- (5) Create an actual or clearly predictable adverse impact on discipline, authority, morale, or mission accomplishment.

c. **Fraternization and improper relationships**

(1) The Army's fraternization policy prohibits certain categories of personal relationships between officers and enlisted personnel regardless of their service. This policy applies to different-gender relationships and same-gender relationships. Violations of the fraternization and improper relationships policy may be punished under Article 92, UCMJ, as a violation of a lawful general regulation.

(2) Categories of prohibited relationships between officers and enlisted personnel include:

(a) Ongoing business relationships. This prohibition does not apply to landlord/tenant relationships or to one-time transactions such as the sale of an automobile or house, but does apply to borrowing or lending money, commercial solicitation, and any other type of ongoing financial or business relationship.

(b) Dating and or shared living accommodations other than those directed by operational requirements, and intimate or sexual relationships.

(c) Gambling.

(3) Other prohibited relationships:

(a) **Personal relationships between permanent party members and IET Soldiers.**

- Any relationship between permanent party personnel and IET Soldiers not required by the training mission is prohibited. This includes, but is not limited to, the following:
  - Drinking, dancing, or gambling.
  - Writing and/or receiving personal letters.
  - Riding in permanent party privately owned vehicles.
  - Having sexual conversations, contact (kissing, hugging, caressing, fondling, handholding), or intercourse.
- The prohibition against any relationship between permanent party personnel and IET Soldiers applies to permanent party personnel without regard to the installation assignment of the permanent party member or the trainee.
- Personal relationships between recruiters and recruits Any relationship between permanent party personnel assigned or attached to the U.S. Army Recruiting Command and potential prospects,

## TRADOC Pam 600-4

applicants, members of the Delayed Entry Program or Delayed Training Program, not required by recruiting mission, is prohibited.

### (b) **Romantic relationships between IET Soldiers**

(1) Illegal associations between IET Soldiers involve any actual or attempted consensual contact or socializing between or among Soldiers who are in basic combat training (BCT) or AIT. Soldiers are therefore expected to avoid the following associations and acts:

- Consensual contact or socializing (between or among Soldiers who are in BCT or AIT) which involves handholding, embracing, caressing, kissing, touching, massaging or fondling of a sexual nature, engaging in sexual intercourse, or sodomy.
- Use of sexually explicit, suggestive, or obscene language or gestures directed towards, or with respect to another Soldier in BCT or AIT.
- Gender-based or race-based harassment or disparaging language or actions (by a Soldier or a group of Soldiers in BCT or AIT) directed towards another Soldier or group of Soldiers in BCT or AIT.
- Entry into the living quarters, latrines, or other areas designated for the exclusive use of Soldiers of the opposite sex, unless required by training mission/ official duties or for health or safety emergencies.

(2) Language or socializing of a non-sexual, non-harassing nature between BCT and AIT Soldiers is not illegal if interaction is based on the esprit and enthusiasm generated by the basic training mission and the professional development associated with BCT and AIT.

(3) Finally, there is no prohibition against IET Soldiers of the same or opposite sex talking to one another or developing friendships.

## **3-9. Army Sexual Harassment Policy**

a. The policy of the U.S. Army is that sexual harassment is inappropriate and unacceptable conduct. Sexual harassment destroys teamwork and is detrimental to combat readiness. The Army is an organization of people, and its success is based on their ability to perform in an environment of mutual respect, dignity, and fair treatment.

b. Categories of **sexual harassment** include:

- (1) Verbal (Example: Telling sexual jokes).
- (2) **Non-verbal** (Example: Blowing kisses).
- (3) Physical **contact** (for example, touching or blocking a doorway).

c. Individuals who believe they are being sexually harassed are responsible to help resolve the issue. One way of accomplishing this is by confronting the harasser and telling him/her that the behavior is not appreciated, not welcome, and must stop. Another way of resolving sexual harassment is to file an informal or formal complaint.

Intimidation, harassment, or retaliation against those filing a complaint is not permitted.

d. Sexual harassment is a form of gender discrimination that involves unwelcome sexual advances, requests for sexual favors, and other verbal or physical conduct of a sexual nature. The following conditions are indicators of sexual harassment.

(1) When submission to or rejection of such conduct is made a term or condition of a person's job, pay, or career.

(2) When submission to or rejection of such conduct is used as a basis for career or employment decisions affecting that person.

(3) When such conduct creates an intimidating, hostile, or offensive working environment, or unreasonably interferes with an individual's work performance.

e. Any person in a supervisory or command position who uses or condones any form of sexual behavior to control, influence, or affect the career, pay, or job of a military member or civilian employee is engaging in sexual harassment.

f. Any Soldier or civilian employee who makes deliberate or repeated unwelcome verbal comments, gestures, or physical contact of a sexual nature is engaging in sexual harassment.

g. If you are uncomfortable because of certain sexual remarks or behaviors, you should be assertive. In responding to behavior that is or may become sexual harassment, you should tell the person how you feel. Describe what you do not like. Stay focused on the behavior and its impact. Clearly state what you want in the future. Tell any potential offender, "I do not want to hear that again" or, "Do not touch me again."

h. If harassment continues after you have warned the harasser of their words and actions, go to your immediate superior unless that is the person doing the harassing. In that case, go to his superior. If appropriate action is not taken, you may want to go up the chain of command or to the post EO adviser.

i. Sexual harassment is only one form of discrimination. Gender discrimination and discrimination based on race, religion, color, or national origin are also against the law.

j. To determine if conduct falls under the category of sexual harassment, consider the following questions:

(1) Is the behavior sexual in nature?

(2) Is the behavior unwelcome?

(3) Does the behavior create a hostile or offensive work environment?

(4) Have sexual favors been demanded, requested, or suggested (especially as a condition of employment or career and job success)?

k. Suggested individual actions to deal with sexual harassment include:

(1) Confront the harasser.

(2) File a complaint.

(3) Use an intermediary spokesperson.

(4) Write a letter to the harasser about the behavior and the expected resolution.

(5) Report the harassment to the chain of command.

### **3-10. Appropriate behavior**

a. The phrase “appropriate behavior” describes how you, as a good Soldier, are expected to behave. You are a Soldier 24 hours a day and should always behave honorably. How you act reflects upon yourself, your unit, and those fighting men and women who have given their lives fighting for America.

b. Examples of inappropriate behavior include alcohol and drug abuse, and intolerance of others. As a Soldier, you can help prevent inappropriate behavior by promoting:

(1) Behavior that is based on the Army Values— LDRSHIP (see chapter 2).

(2) Tolerance of those different from us.

(3) Ethical decisionmaking.

(4) Adherence to the code of conduct.

c. You can also help prevent inappropriate behavior by demonstrating RESPECT for others, their property, and respect for yourself.

### **3-11. Alcohol and drug abuse**

a. Your success in the Army is dependent upon you being a good Soldier on and off duty. As a Soldier, you are obligated to abstain from illegal drug use, avoid the abuse of prescription and over the counter medications, and make responsible decisions about your alcohol use. If you choose to abuse these substances, you will be subject to administrative and judicial actions.

b. Abuse of alcohol or the use and abuse of drugs is inconsistent with Army values. Substance abusers cannot maintain the standards of performance, discipline, and readiness necessary to accomplish the Army's mission. Soldiers identified as abusers of alcohol or other drugs may be entered into an Army Substance Abuse Program (ASAP) rehabilitation program. The ASAP is a command program a commander will direct detected problem Soldiers into if he/she feels they have potential for continued military service. Soldiers failing to respond to rehabilitative efforts, or who are deemed unfit for further Military service, will be discharged.

c. Self referral is the most desirable method of identifying alcohol or other drug abusers. If your work performance, conduct, relationships, or health becomes impaired because of the abuse of alcohol or other drugs, you have a personal obligation to seek help. You can ask for help through your chain of command, the ASAP or the chaplain. Most Soldiers who self refer for treatment will not have their previous drug or alcohol use violations used against them in judicial actions.

**3-12. Consideration of others**

- a. Diversity is a positive aspect of military service. Consideration of others is defined as “those actions that indicate a sensitivity to and regard for the feelings and needs of others and an awareness of the impact of one’s own behavior on them; being supportive of and fair with others.”
- b. The objective of the consideration of others program is to foster and strengthen the command climate by reinforcing the importance of trust, teamwork, dignity, and respect for others.

**3-13. Homosexual conduct policy “Don’t Ask, Don’t Tell, and Don’t Harass”**

- a. Sexual orientation is a private, personal matter.
- b. Sexual orientation alone is not a bar to enlistment or continued service in the military.
- c. Homosexual conduct, on the other hand, is incompatible with military service. The DOD has defined three types of homosexual conduct: **statement**, **act**, and **marriage**.
  - (1) **Statement:** can be conveyed through language or behavior and indicates a propensity (i.e. likelihood) or intent to engage in homosexual acts. The Soldier can present evidence that he/she does not engage in homosexual acts and does not have a propensity or intent to do so.
  - (2) **Act:** any bodily contact, actively undertaken or passively permitted, between persons of the same sex for the purpose of satisfying sexual desires, and any bodily contact (for example, hand holding, slow dancing, or kissing) that a reasonable person would understand to demonstrate a propensity or intent to engage in such bodily contact.
  - (3) **Marriage:** marrying or attempting to marry a person of the same sex.
- d. The Army’s basic policy is, “Don’t ask, don’t tell.” This policy also means, “Don’t Harass.”
  - (1) “**Don’t Ask.**” The Army and individual Soldiers have a responsibility not to ask about homosexual orientation.
  - (2) “**Don’t Tell.**” Soldiers should not disclose their sexual orientation. If Soldiers disclose their orientation, it may be used to separate them from the Army.
  - (3) “**Don’t Harass.**” Soldiers will not harass other Soldiers based upon sexual orientation or conduct.
- e. Commanders will initiate an inquiry into homosexual conduct only when he or she has received credible information that there is a basis for discharge. Credible information does not exist, for example, when there is only mere suspicions, rumors, opinions, or associational behavior such as associating with known homosexuals, frequenting

#### TRADOC Pam 600-4

homosexual or “alternative lifestyle” bars, reading homosexual publications, or participating in homosexual rallies in civilian clothes.

f. Remember the rule - sexual orientation alone is not a bar to entry or continued military service. However, if you reveal homosexual conduct, you open yourself up to questioning by the commander and adverse action, such as administrative separation.

g. Don't harass. Harassment of a Soldier based upon sexual orientation or conduct is inappropriate. Harassment includes oral comments (on or off duty), derogatory references or language, jokes about homosexuals, jody calls about homosexuals, anonymous calls, or e-mails.

h. Harassment should be reported to the chain of command or other channels. Commanders will investigate and take appropriate action to protect the safety of the Soldier, on and off duty. Each case will be treated individually depending on the facts. If a Soldier has a concern or if they are uncomfortable discussing issues regarding homosexual conduct with the chain of command, they can discuss those matters in confidence with either a legal assistance attorney or chaplain.

i. Soldier harassment reports are not to be considered accurate until verification. When a Soldier reports harassment to commanders, it is not an admission of homosexuality, and commanders should not regard it as such. Threats or harassment based on a Soldier's perceived or alleged homosexuality does not, by itself, constitute credible information justifying an inquiry about homosexual conduct of the harassed Soldier.

j. Homosexual conduct remains incompatible with military service. All Soldiers, including those suspected of being homosexuals or pending separation for homosexuality, deserve to be treated with dignity and respect. Every Soldier has the right to expect treatment consistent with our core Army values, a safe and secure living and working environment, and the support of their chain of command.

#### **3-14. Dignity and respect**

a. Respect is one of the seven bedrock Army values. All Soldiers will be treated with dignity and respect at all times. As a Soldier, you will also be afforded a safe and secure environment in which to live and work.

b. Remember the golden rule—treat others as you wish to be treated, or how you would want your son or daughter to be treated.

c. If you are the victim of harassment or threats, try to resolve it yourself. If the treatment continues, report it to your chain of command. Commanders at every level will take appropriate action to prevent harassment or threats and provide safe and secure living and working environments.

d. Treating individuals with dignity and respect promotes compliance with Army policies concerning sexual harassment, racial and gender equality, homosexuality, consideration of others, and core Army

values. Our Army enjoys a worldwide centuries-earned reputation for fighting ferociously and treating people with dignity and respect. We must continue that tradition.

### **3-15. Rape and sexual assault prevention**

- a. A sexual assault is defined as intentional sexual contact, characterized by use of force, physical threat or abuse of authority or when the victim does not or cannot consent. Sexual assault includes rape, nonconsensual sodomy (oral or anal sex), indecent assault (unwanted, inappropriate sexual contact or fondling), or attempts to commit these acts. It can occur in any type of relationship, including marriage.
- b. Sexual assault is a criminal offense incompatible with the Army's high standards of professionalism and discipline. Sexual assault committed by a Soldier degrades mission readiness by devastating the Army's ability to work effectively as a team. Commanders and supervisors of perpetrators will take appropriate disciplinary action and/or administrative action.
- c. Male and female Soldiers can commit rape. The types of rape include physical and constructive force, date/acquaintance rape, and marital rape.
- d. Suggested actions to prevent becoming a victim:
  - (1) Be aware of your surroundings and be careful not to overindulge in alcohol.
  - (2) Walk only in lighted areas after dark.
  - (3) Buy time with the rapist by talking.
  - (4) Attract help/attention.
  - (5) Report misconduct.
  - (6) Do not be intimidated.
- e. Soldiers can report a sexual assault by using either restricted reporting or unrestricted reporting
  - (1) *Restricted reporting.* Restricted reporting allows a Soldier who is a sexual assault victim, on a confidential basis to disclose the details of his/her assault to specifically identified individuals and receive medical treatment and counseling, without triggering the official investigative process. Soldiers who are sexually assaulted and desire restricted reporting under this policy should report the assault to the sexual assault response coordinator (SARC), installation or unit victim advocate, chaplain, or a military healthcare provider.
  - (2) *Unrestricted reporting.* Unrestricted reporting allows a Soldier who is sexually assaulted and desires medical treatment, counseling, and an official investigation of his/her allegation to use the traditional reporting channels such as the chain of command, law enforcement, healthcare providers, etc. Details regarding the incident will be limited to only those personnel who have a legitimate need to know.
- f. If you are a victim, you should:
  - (1) Go to a safe place where a phone is available.



#### TRADOC Pam 600-4

- (2) Call the local or military police.
  - (3) Avoid showering, douching, changing clothes, or straightening up the site where you were victimized since that may affect any subsequent investigation that may occur.
  - (4) Go directly to a hospital or clinic and have the police notified for you.
  - (5) Call someone from your chain of command, a friend, a rape hotline, or social work services.
- g. When assisting a victim, you should:
- (1) Listen to what the victim has to say and sympathize.
  - (2) Do not ask what the victim did to cause this to happen.
  - (3) Support the victim in the decision and effort to report the crime.
  - (4) Encourage them to talk to a professional counselor.

#### **3-16. Soldier stress and a resilient attitude: You can make it**

a. A Soldier in the Army, whether in training or in combat, will face challenges everyday, especially when they are in a new place with new rules. A successful Soldier is often the one who can “bounce back” and adapt to change. How do people deal with difficult events that change their lives? All of us need to face life’s problems with a “resilient” attitude. “Resilience” is simply “bouncing back” with a positive outlook to overcome difficulties or challenges. Being “resilient” does not mean you do not feel fear or pain. We all are afraid or sad at times; we would not be human otherwise. It is what you do to ‘accomplish the mission’ despite your fears that counts. “Resilience” is not inborn; it is attitudes and skills that can be learned and developed in anyone. Soldiers learn to be resilient by being ‘mentally tough’ and to “never quit; never accept defeat” through realistic training.

b. Common causes of fear and sadness are:

- (1) Being away from home and loved ones, especially for the first time. Part of growing up is making this critical first step.
- (2) Uncertainty. Changes in sleep, food, clothing, schedules, and personal habits.
- (3) Fear of failure. Having difficulty in keeping up with everybody else.
- (4) Coming from an abusive childhood.

c. Everyone reacts to new events in different ways, but common, normal reactions we all have are:

- (1) Sleeping poorly.
- (2) Not eating well.
- (3) Feeling angry, sad, or hopeless.
- (4) Feeling like you want to quit or run a way.

d. There are positive actions you can take to help yourself:

- (1) Connect **with family and friends**. Staying connected with your family and friends who care about you and will listen to you helps you stay strong. Write letters so you will get letters. Call, text, or e-mail friends and family whenever authorized.

(2) **Keep things in balance.** Try not seeing every problem as unsolvable or a disaster. You can change how you see and feel about events. Is this event really the “end of the world?”

(3) Value **change.** Change is part of growing up and becoming an adult. Change can have a positive and sometimes a negative impact on you. Your attitude can help you find the “silver lining.” For example, you may have sore muscles at first, but you will also be getting stronger every week.

(4) Keep **your eye on your goals.** Whatever you want to be in life, you would have to spend hundreds or thousands of hours learning your skills. There will be days when you and everyone else will feel tired, frustrated, and sore. Develop some small goals. What is one thing you can do better today? Think about why you joined the Army. Whether you joined to serve America, get a good job, or get money for college, then your short time in basic training is helping you get to that goal.

(5) Take **positive corrective action.** Take positive actions, rather than ignoring problems and wishing they would just go away, is important. Even if the issue is not immediately solvable, doing positive things for you helps. Write a letter, make a phone call, talk to a friend or chaplain, etc. If you are feeling overwhelmed, remember a strong Soldier asks for help. The Army has many resources for all kinds of problems (talk to your drill sergeant). If you are feeling nervous or overwhelmed, stop what you are doing, take three deep breaths, tense all your muscles for a ten-count, then relax. Repeat 10 times.

(6) Grow **from experiences.** You may find you have become stronger from a struggle; that working hard and overcoming obstacles makes you feel better about yourself. How can you improve to do better next time? When you make a mistake, and we all make mistakes, how can you fix it?

(7) Believe **in yourself.** Say positive things about yourself. “I’m a survivor.” “I can adapt, overcome, or improvise to win in a tough situation.” “I like learning new things.” Develop confidence in your ability to solve problems. You are one of the few brightest and best Americans able to qualify for the Army.

(8) **Take care of you.** An ‘empty pitcher can’t pour milk.’ Sleep, food, and water are critical to thinking clearly. Never make an important decision when you are tired, hungry, angry or sad. Not hungry? Eat something anyway. Don’t like the new food? Eat something you do like, or just eat something. Guess what? Your food tastes will change in a few days.

(9) Ask **for help.** People are willing to make sacrifices for things or people they believe in, just like your parents did for you. What do you believe in? Go to church. Talk to your battle buddy, drill sergeant, or chaplain. No one is alone in the Army; there are all kinds of Soldiers and civilians standing by to help you, whether chaplains, counselors, doctors, or experts in some area (pay, family resources, etc.). If, for example, you had an abusive childhood and you see consistent patterns

## TRADOC Pam 600-4

of risky behaviors on your part (smoking, alcohol/drug abuse, bad relationships, legal troubles, etc.), then there is help available.

e. Everyone will find that the world is unfair on some days, and some may find that “bad things happen to good people”. The important thing is to not be trapped into defining yourself as a “permanent victim,” but instead look for ways to change your life in a positive direction. YOU can make it. In a few short weeks, you will be on the graduation parade field, feeling happy and proud that you earned the privilege to be a Soldier. Your parents and friends will cheer because they know it was tough, but you were tough as well. Remember, your fellow Soldiers need you beside them. It’s the team that succeeds and wins each battle.

### 3-17. Suicide prevention

a. Some Soldiers get so overwhelmed by all the things that are happening to them that they make impulsive decisions to harm himself or herself or someone else. ALWAYS take immediate action to tell your drill sergeant or someone in authority regardless of whether you think you are afraid of losing friendships, butting-in where you do not belong, or getting someone in trouble. As a Soldier, it is your responsibility to have the personal courage and loyalty to your fellow Soldiers to help them not to be harmed.

b. Threats of harming self or others are important warning signs. You may think the Soldier is kidding. NEVER take these threats lightly. Get medical help for your buddy before they get to the stage of thinking there is no other way to solve their problems.

c. Suicide prevention.\*

NOTE: \*Adapted from the American Psychological Associations’ “The Road to Resilience” with permission.

(1) What can you do to help a possible suicidal person? Provide “AID.”

(a) A - Ask. Do not be afraid to ask, “Are you thinking about hurting yourself?”

(b) I - Intervene immediately.

(c) D - do not keep it a secret.

(2) Five things to say to a possible suicidal person:

(a) “I hear you.”

(b) “I understand.”

(c) “I care about you.”

(d) “You’re not alone.”

(e) “Let’s go together and get someone to help you.”

(3) Five things NOT to say to a possible suicidal person:

(a) “You’ll snap out of it.”

(b) “It’s just a phase.”

(c) “Stop being so selfish.”

(d) “You are just trying to get attention.”

(e) “You are a jerk; everyone has problems.”

- (4) Not all Soldiers really want to die, even if they are saying it. They just do not know what else to do!
- (5) Follow the acronym LIFE. All four steps in the acronym LIFE are EQUALLY important. Follow all these steps together:
- (a) L - Locate help: drill sergeant, charge of quarters, staff duty NCO or officer, chaplain, doctor, nurse, friend, family, crisis line, hospital, emergency room. Whatever it takes; obtain help.
- (b) I - Inform: drill sergeant, chain of command, chaplain, or chaplain's assistant, medical personnel.
- (c) F - Find: Someone to stay with the person or to go for help while you stay with them.
- (d) E - Expedite: Locate help immediately. A suicidal person needs immediate attention by trained professionals.
- (6) Harming yourself or others is a permanent mistake to a temporary problem. Suicidal thoughts are usually temporary. Although it might seem as if the unhappiness will never end, it is important to realize that crises do end. Solutions are found, situations change, feelings change, and unexpected positive events occur. You may think that someone was your "one true love for forever," but you will love again; you can find ways to adapt, overcome, and solve problems.

### **3-18. Ethical decisionmaking**

- a. The decisions that you make can have a far-reaching effect upon yourself, your unit, and the Army. It is up to you to make the ethical decision. An ethical decision is one that complies with the spirit and letter of the laws and regulations governing ethical conduct and the seven Army Values.
- b. The ethical decisionmaking process involves asking yourself the following questions with follow-up action.
- (1) What problem am I facing?
  - (2) What are my choices?
  - (3) Which choice is most consistent with Army values and regulations?
  - (4) Make your decision and execute your plan.
- c. In making ethical decisions, all Soldiers must be familiar with the laws and regulations that govern ethical conduct.
- (1) Executive Order 12731 sets forth the following 14 principles of ethical conduct, summarizing ethics laws and regulations, that military personnel must follow:
- (a) Public service is a public trust, requiring employees to place loyalty to the Constitution, the laws and ethical principles above private gain.
  - (b) Employees shall not hold financial interests that conflict with the conscientious performance of duty.

TRADOC Pam 600-4

(c) Employees shall not engage in financial transactions using nonpublic Government information or allow the improper use of such information to further any private interest.

(d) An employee shall not, except as permitted by the Standards of Ethical Conduct, solicit or accept any gift or other item of monetary value from any person or entity seeking official action from, doing business with, or conducting activities regulated by the employee's agency, or whose interests may be substantially affected by the performance or nonperformance of the employee's duties.

(e) Employees shall put forth honest effort in the performance of their duties.

(f) Employees shall not knowingly make unauthorized commitments or promises of any kind purporting to bind the Government.

(g) Employees shall not use public office for private gain.

(h) Employees shall act impartially and not give preferential treatment to any private organization or individual.

(i) Employees shall protect and conserve Federal property and shall not use it for other than authorized activities.

(j) Employees shall not engage in outside employment or activities, including seeking or negotiating for employment, that conflict with official Government duties and responsibilities.

(k) Employees shall disclose waste, fraud, abuse, and corruption to appropriate authorities.

(l) Employees shall satisfy in good faith their obligations as citizens, including all financial obligations, especially those -- such as Federal, State, or local taxes -- that are imposed by law.

(m) Employees shall adhere to all laws and regulations that provide equal opportunity for all Americans regardless of race, color, religion, sex, national origin, age, or handicap.

(n) Employees shall endeavor to avoid any actions creating the appearance that they are violating the law or the ethical standards set forth in the Standards of Ethical Conduct. Whether particular circumstances create an appearance that the law or these standards have been violated shall be determined from the perspective of a reasonable person with knowledge of the relevant facts.

d. Complete ethics information is available online at:

(1) Office of Army General Counsel (Ethics & Fiscal)

[www.hqda.army.mil/ogc/eandf.htm](http://www.hqda.army.mil/ogc/eandf.htm) click on "Ethics Links"

(2) 5 C.F.R. Part 2635 - Standards of Ethical Conduct for Employees of the Executive Branch

[http://www.usoge.gov/laws\\_regs/regulations/5cfr2635.aspx](http://www.usoge.gov/laws_regs/regulations/5cfr2635.aspx)

(3) Joint Ethics Regulation (JER) DOD 5500.7-R

<http://www.hqda.army.mil/ogc/JER%201-6.doc>

e. Be smart—if you have an ethics question, contact your local legal office and ask your ethics counselor for advice BEFORE you act, or contact the TRADOC Ethics Counselor at [MONR-TRADOCsJA@conus.army.mil](mailto:MONR-TRADOCsJA@conus.army.mil),

telephone number (757) 788-2302

(DSN 680), mailing address HO TRADOC-OSJA, 11 Bernard Road, Building 10, Suite 319, Fort Monroe, Virginia 23651.

### 3-19. Awards and decorations of the U.S. Army

a. **Personal decorations/awards** are conferred upon the individual for his or her act of heroism, specific act of gallantry, or for meritorious service during military or non-military feats. The act or acts of heroism must have been so notable and have involved risk of life so extraordinary as to set the individual apart from his or her comrades. Some of these decorations, arranged in order of the degree of valor or achievement, are described as follows.

(1) The **Medal of Honor** is the highest and most rarely awarded decoration conferred by the U.S. The medal is awarded for conspicuous gallantry and intrepidity at the risk of his or her life above and beyond the call of duty while engaged in an action against an enemy of the U.S. Commended Medal of Honor actions must take place:

- (a) While engaged in actions against “hostile” forces.
- (b) While engaged in military operations involving conflict with opposing foreign force.
- (c) While serving with friendly foreign forces engaged in an armed conflict against an opposing armed force in which the U.S. is not a belligerent party.

(2) The **Distinguished Service Cross** is awarded to a person who, while serving in any capacity with the Army, distinguishes himself or herself by extraordinary heroism not justifying the award of a Medal of Honor. Commended Distinguished Service Cross actions must take place:

- (a) While engaged in an action against an enemy of the U.S.
- (b) While engaging in military operations involving conflict with an opposing/foreign force.
- (c) While serving with friendly foreign forces engaged in an armed conflict against an opposing Armed Force in which the U.S. is not a belligerent party.

(3) The **Purple Heart** is awarded to persons serving in any capacity as a member of the U.S. Armed Forces who are killed or wounded (requiring treatment by a medical officer) in any action against enemies of the U.S. Commended purple heart actions must take place as a result of wounds caused by an enemy or opposing armed force; or as the result of maltreatment inflicted by captors when held as a prisoner of war.

b. **Collective (unit) citations** are made to an operating unit for outstanding performance inside or outside of the U.S. It is worn by only those persons who were members of that unit during the action or period specified by the award.

c. **Commemorative, campaign, and service medals** are issued to Soldiers who take part in particular campaigns or periods of service for which a medal is authorized.

(1) The **Army Good Conduct Medal** recognizes enlisted women and men who have served with exemplary behavior, efficiency, and fidelity in active Federal military service.

(2) Qualifying periods of service include:

(a) Each 3 years completed on or after 27 August 1940.

(b) For first award only, upon termination of service on or after June 27, 1950, of less than 3 years but more than 1 year.

(c) For first award only, upon termination of service on or after June 27, 1950, of less than 1 year when final separation was by reason of physical disability incurred in line of duty.

(d) For first award only, for those individuals who died before completing 1 year of active Federal military service if the death occurred in the line of duty.

(e) The following disqualification rules must be observed.

- Conviction by courts-martial terminates a period of qualifying service. A new period begins the following day after completion of the sentence imposed by courts-martial.

- Individuals whose retention is not warranted under standards prescribed in Army Regulation 604-10, paragraph 2-1, or for whom a bar to reenlistment has been approved under the provisions of Army Regulation 601-280, chapter 6, are not eligible for award.

- Disqualification as determined by the unit commander. The commander will prepare a statement of rationale for his/her decision. The statement will include the period of disqualification and will be referred to the individual.

- Disqualification for an award of the Army good conduct medal can occur at any time during a qualifying period (for example, when the manner of performance or efficiency declines.)

d. **Marksmanship badges** are awarded to individuals who qualify because they have demonstrated some special proficiency or skill.

(1) Marksmanship badges are worn to indicate the individual's prowess with:

(a) Specific weapons, pistols, and/or rifles.

(b) During specified competitions, matches, or practice exercises.

e. **Marksmanship trophies** are awarded at various levels to include:

(1) U.S. and international distinguished shooter competitions.

(2) U.S. Army rifle and pistol championships.

(3) National trophies for rifle and pistol championships.

(4) Inter-service rifle and pistol matches.

(5) Combat exercises.

(6) Division contests.

**3-20. Terrorism**

a. In 1991, one Soldier was killed in Panama in a drive-by shooting and one Air Force SGT was killed by the entryway of his Korean apartment house. In 1992, a Soldier was killed in an ambush in Panama. Personal animosity did not cause these incidents. These Soldiers were killed simply because they were American military personnel.

b. As symbols of U.S. power, Soldiers are always at risk from criminals and terrorists. While the level and type of threat vary from place to place and time to time, you can do several things to make yourself less likely to be the target of a criminal or terrorist.

c. By practicing these principles at all times, you will be better prepared for that time when you are living and working in an elevated threat environment.

d. These principles include:

(1) Know the threat in your area. Be especially cautious in high-crime areas or areas with a history of terrorist activity.

(2) Routinely practice crime-prevention measures.

(3) Be inconspicuous. DO NOT call attention to yourself by dress or action, such as by talking loudly or flashing large sums of money.

(4) Involve your family in security. A good personal security program covers security at work, at home, and while traveling.

(5) Ensure family members know where other members are at all time

(6) Ensure children DO NOT give any personal information, such as phone numbers, where parents work or other places, to strangers.

(7) Answer the phone "Hello"; never give your name until the caller identifies himself or herself.

(8) Ensure family members know emergency phone numbers (police, fire, medical).

(9) When traveling, DO NOT discuss your work with strangers (no one on the bus, airplane, or train needs to know that you are a Soldier).

(10) DO NOT use luggage or wear clothing or accessories that identify you as a Soldier.

(11) DO NOT work or drive in isolated or high-crime areas.

(12) Avoid public demonstrations.

(13) Know where safe areas are (police stations, military installations).

(14) Report all suspicious personnel or activities, to include surveillance, to the proper authorities (chain of command, security officer, and police). DO NOT confront suspicious personnel.

e. Above all, stay alert. If something seems "wrong," it might well be. Most attacks against U.S. military personnel occur when off-duty or when traveling personnel do not follow sound security practices.

f. Remember, there is no honor in becoming a victim of a criminal or terrorist attack, so practice personal protection to keep yourself and your family from becoming a victim.



**THIS PAGE LEFT BLANK INTENTIONALLY.**

## Chapter 4

### Basic Soldier Skills

#### 4-1. The buddy system

- a. **The Army's buddy system provides every Soldier an assigned buddy.**
- b. **Requirements to be a buddy:**
  - (1) In IET, the norm is only same-gender Soldiers will be buddies.
  - (2) If there are non-English speaking Soldiers in a platoon, they will be paired with English-speaking buddies who can assist in interpreting instructions.
  - (3) You will be paired based on your strengths that can complement another's weaknesses.
- c. **Responsibilities of a buddy:**
  - (1) Never go anywhere without a buddy.
  - (2) Inform your buddy where you will be at all times.
  - (3) Pass on information that might affect your buddy.
  - (4) Discuss each day's training and the next day's activities
  - (5) Lean on each other for problem solving. Help each other.
  - (6) Encourage your buddy to successfully complete all training requirements.
  - (7) Make sure your buddy adheres to appearance and conduct standards.
  - (8) Inform the drill sergeant of any problems or status changes in your buddy.
  - (9) Assist your buddy in living the Army core values.
- d. **The Soldier's responsibilities to the unit team:**
  - (1) Commit to the squad, platoon, company, and unit above self.
  - (2) Cooperate with peers to accomplish goals.
  - (3) Adopt standards and values of the unit.

#### 4-2. Drill and ceremonies

- a. Many drill procedures used by the U.S. Army today were developed during the Revolutionary War. The purpose of the drill then was to instill discipline in American Soldiers. As these Soldiers mastered the art of the drill, they began to work as a team and develop a sense of pride in themselves and in their unit.
- b. In today's Army, the same objectives—teamwork, confidence, pride, alertness, attention to detail, esprit de corps, and discipline are accomplished by drill.
- c. A drill consists of a series of movements by which a unit or individuals are moved in an orderly, uniform manner from one formation or place to another. Units vary in size, but in BCT, you will ordinarily be part of a squad, platoon, company, battalion or brigade. Figure 4-1 illustrates some drill formations without weapons

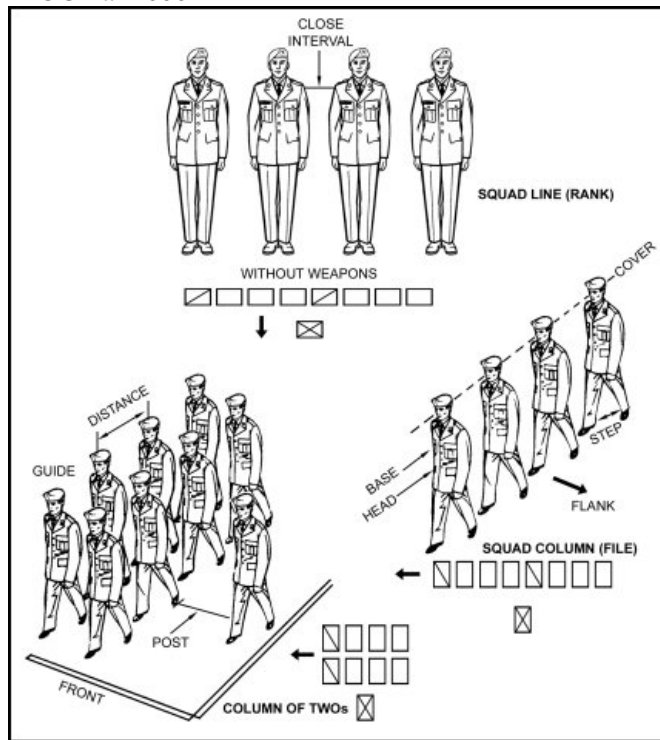

**Figure 4-1. Drill formations (without weapons)**

d. You will need to know the following drill terms:

- (1) Element. This is an individual, squad, section, platoon, company, or larger unit formed as part of the next higher unit.
- (2) Formation. This is an arrangement of the unit's elements in a prescribed manner such as a line formation in which the elements are side-by-side, and column formation in which the elements are one behind the other. In a platoon column, the members of each squad are one behind the other with the squads abreast.
- (3) Front. This is a space from one side to the other side of a formation, and includes the right and left elements.
- (4) Depth. This is a space from the front to the rear of a formation, including the front and rear elements.
- (5) Distance. This is the space between elements that are one behind the other. The distance between individuals is an arm's length, plus 6 inches, or approximately 36 inches measured from the chest of one Soldier to the back of the Soldier immediately to his front.
- (6) Interval. This is the space between side-by-side elements.
- (7) Rank. This is a line that is only one element in depth.
- (8) File. This is a column that has a front of one element.
- (9) Guide. This is the person responsible for maintaining the prescribed direction and rate of march.

(10) Post. This is the correct place for an officer or NCO to stand in a prescribed formation.

(11) Head. This is a column's leading element.

(12) Base. This is the element around which a movement is planned or regulated.

(13) Cadence. This is a uniform rhythm or number of steps or counts per minute.

(14) Quick time. This is a cadence of 120 counts (steps per minute).

(15) Double time. This is a cadence of 180 counts (steps per minute).

e. Drill commands are oral orders given by your commander or leader, usually in two parts. The preparatory command states the movement to be carried out and gets you ready to execute the order. The command of execution tells when the movement is to be carried out. In the command "Forward, march," the *preparatory* command is "Forward," the command of *execution* is "March."

f. In some commands, the preparatory command and the command of execution are combined. For example, "Fall in," "at ease," and "Rest." These commands are given without inflection and at a uniformly high pitch and loudness comparable to that of a normal command of execution.

### 4-3. Inspections

There are four inspection periods within the first nine weeks of training.

a. The **first inspection** is a working inspection covering inspection of bunks, wall lockers, individual clothing, and equipment. It will take place at the beginning of the cycle and introduce Soldiers to Army inspection procedures.

b. The second inspection is a stand-by inspection. Items to be inspected include: bunks, wall lockers, individual clothing, and equipment.

c. The **third inspection** period is an in-ranks inspection, and covers open and close ranks, inspection arms, port and order arms, and proper courtesy in an in-ranks inspection.

d. The **fourth inspection** period in basic training is a stand-by inspection. Items to be inspected include: Class A uniforms, weapons, protective masks, bunks, wall lockers, and common areas.

### 4-4. Personal appearance and uniform

a. Personal appearance is important—it demonstrates the pride and self-discipline you feel as a Soldier in the U.S. Army. Being neat and well groomed contributes to the esprit in your unit. Your uniform should fit well and be clean, serviceable, and pressed as necessary.

b. Your uniform is only part of your appearance. To look like a Soldier, you need to be physically fit, meet acceptable weight

TRADOC Pam 600-4

standards, and have a neat hairstyle in accordance with Army regulations.

c. **Hairstyle.** Many hairstyles are acceptable in the Army for Soldiers who have completed BCT.

(1) Male personnel—the hair must not fall over the ears or eyebrows, or touch the collar (except for closely cut hair at the back of the neck).

(a) Hair should be tapered, except that "block cut" fullness in the back is permitted in moderate degree.

(b) Neither the bulk nor length of hair may interfere with the wearing of military headgear.

(c) Sideburns must be neatly trimmed, not flared, and must not extend downward beyond the lowest part of the exterior ear opening.

(d) The face must be clean-shaven, except that mustaches are permitted.

(e) If a mustache is worn, it must be neatly trimmed.

(f) No part of the mustache will cover the upper lip line or extend horizontally beyond or below the corner points of the mouth where the upper and lower lips join.

(2) Female personnel—the hair must not fall over the eyebrows and must not extend below the bottom edge of the collar.

(a) Neither the bulk nor length of hair may interfere with the wearing of military headgear.

(b) Any hair-holding ornaments, such as barrettes or hairpins, must be of a natural hair color or transparent.

(c) Makeup and nail polish should be conservative and complement the uniform.

(d) Unless directed to wear another type of footwear, female personnel may wear pumps with all uniforms except field uniforms.

d. **Jewelry.** A wrist watch, identification bracelet, and up to two rings (a wedding set is considered to be one ring) may be worn with your uniform as long as they are conservative and tasteful. You may wear a religious medal on a chain around your neck provided neither medal nor chain can be seen.

e. **Body piercing.** Except for earrings worn by female Soldiers, no displaying objects, articles, jewelry, or ornamentation attached or affixed to or through the skin may be worn while in uniform. Neither can such adornments be worn while wearing civilian clothes (on or off duty) when on any military installation, or other places under military control. Females may wear any type of earrings off duty, on or off military installations.

f. **Tattoos.** Any tattoo or brand anywhere on the head or face is prohibited except for permanent make-up. Tattoos that are not extremist, indecent, sexist, or racist are allowed on the hands and neck. Initial entry determinations will be made according to current guidance. Any type of tattoo or brand that is visible while wearing a Class A uniform and detracts from Soldierly appearance is prohibited.

**4-5. Uniform wear and maintenance**

a. You are responsible for keeping your clothing in good serviceable condition. Clean your clothing regularly, keep it in good repair, and store it properly. Carrying large or heavy objects in your pockets is likely to change the shape of your tailored clothing.

b. Follow the cleaning and care instructions attached to most clothing. Clean your clothing as soon as possible after it becomes soiled. Dirty clothing wears out more quickly than clean clothing because dirt cuts fibers and holds in moisture from perspiration. Coated clothing such as ponchos and raincoats should be wiped clean or washed by hand with a soft brush and warm soapy water. These items should be thoroughly rinsed and hung up to air-dry.

c. If you need to press clothing, be sure it is clean and that the iron is not too hot. To press cotton clothing, dampen the surface of the cloth, and then apply the iron directly. Before storing clothing, be sure it is clean and dry. Figure 4-2 displays the proper wearing of the uniform beret.

d. **Beret:** The beret shown in figure 4-5 is worn so that the headband (edge binding) is straight across the forehead, 1 inch above the eyebrows.

(1) The flash is positioned over the left eye, and the excess material is draped over to the right ear, extending to at least the top of the ear, and no lower than the middle of the ear.



**Figure 4-2. Beret, male and female**

(2) Personnel will cut off the ends of the adjusting ribbon and secure the ribbon knot inside the edge binding at the back of the beret.

(3) When worn properly, the beret is formed to the shape of the head; therefore, Soldiers may not wear hairstyles that cause distortion of the beret.

**NOTE:** IET Soldiers will not wear unit insignia on the beret until they arrive at their new unit of assignment.

e. **Boots:** New boots should fit properly when you receive them.

(1) They should have a chance to air out between uses, so you should wear one pair one day and another pair the next.

TRADOC Pam 600-4

- (2) Scrape dirt or mud from boots and wash with just a little water and soap.
- (3) Wipe insides dry with a clean cloth and remove all soapsuds from the outside.
- (4) Stuff papers in the toes and let boots dry in a warm, dry place.
- (5) Do not put boots in the hot sun or next to a strong source of heat.
- (6) Let boots dry.
- (7) Heels of boots should be replaced after wear of 7/16 of an inch or more.

f. **Insignia placement:** Each Soldier is responsible for having the correct insignia properly placed on their uniform, as follows:

(1) Shoulder sleeve insignia. Soldiers in both BCT and AIT who are in one of the following categories may wear organizational shoulder sleeve insignia (see figure 4-3). Wear this insignia centered on the left sleeve, 1/2 inch below the top of the shoulder seam on all Army green uniform coats. Subdued shoulder sleeve insignia will be worn on all field and work uniforms.

(a) ARNG and USAR trainees are authorized to wear the insignia of their parent ARNG or USAR organization from the start of training.

(b) Unit-of-choice trainees are authorized to wear, from the start of training, the insignia of the specific unit for which they enlisted.

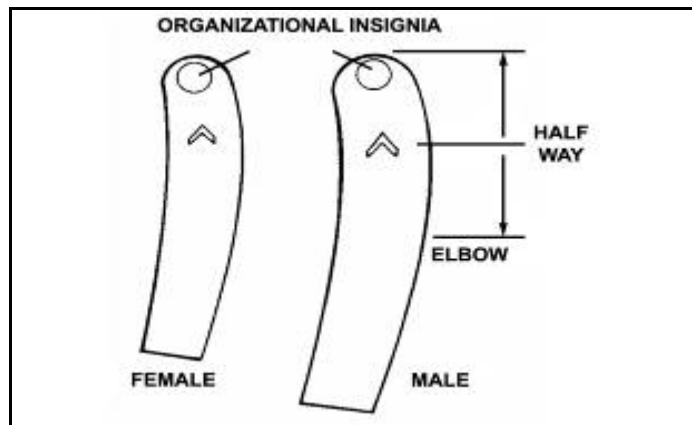
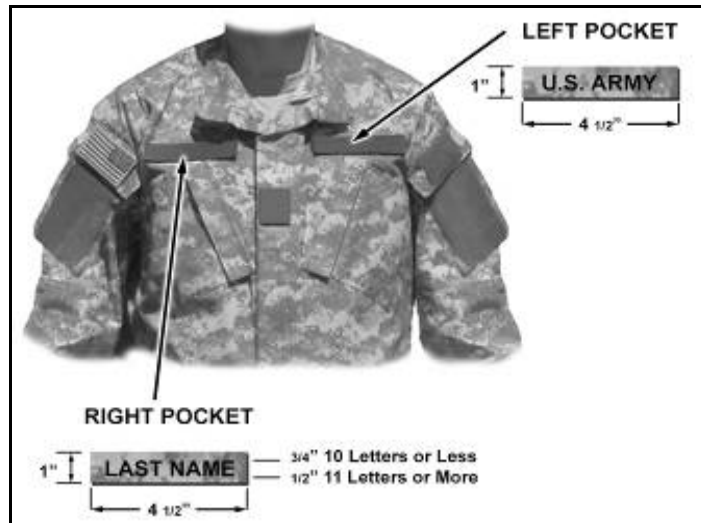

Figure 4-3. Shoulder sleeve insignia of current unit

- (2) "U.S. ARMY" insignia.
  - (a) Worn immediately above and parallel to the top edge of the left breast pocket.
  - (b) This insignia consists of black, 3/4-inch high block letters on a 1-inch wide by 4 1/2-inch long (or to the edges of the pocket flap) strip of olive green cloth.
- (3) Name tape.
  - (a) Worn immediately above, parallel to the top edge of the right breast pocket of all field, and work uniform coats and shirts.

- (b) It consists of black letters on a 1-inch wide by 4 1/2-inch long (or to the edges of the pocket flap) strip of cloth.
- (c) Names of 10 letters or less will be printed in 3/4-inch high Franklin Gothic Condensed.
- (d) Names of 11 letters or more will be printed in 1/2-inch high Franklin Gothic Extra Condensed (see 4-4).
- (e) The name and U.S. Army tapes will be the same length.



**Figure 4-4. Distinguishing insignia**

- (4) Grade insignia.
  - (a) Soldiers wear subdued (cloth) last name and U.S. Army identification insignia attached to Velcro areas shown. Grade insignia is attached to Velcro area provided in center of the jacket flap (see figure 4-5).

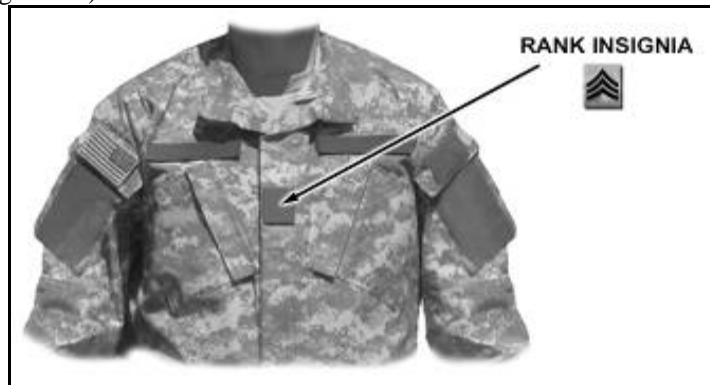

**Figure 4-5. Grade insignia**



(b) The Army green shirt may be worn with or without the Army green coat.

(c) E-4s (Specialists 4) and below must always wear their grade insignia on the collars of the green shirt (see figure 4-6).

(d) Corporals and above must wear shoulder board grade insignia on the green shirt.

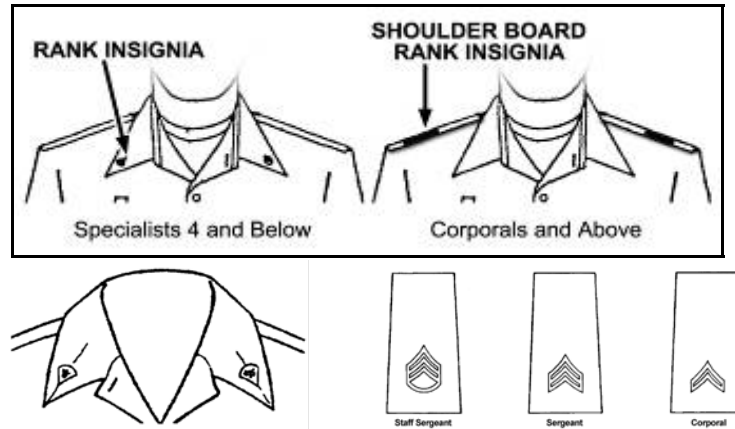

**Figure 4-6. Grade insignia, enlisted**

(5) U.S. and branch insignia - male.

(a) During IET, males will wear the "U.S." insignia disk on both collars.

(b) The bottom of the insignia disk will be 1 inch above the notch where the collar meets the lapel, centered between the seam and the outside edge of the collar. The "U.S." or branch insignia will be canted parallel to the inside edge of the lapel on the Army green, Army white, and Army blue uniform coats (see figure 4-7).

(c) After completing AIT or OSU, male Soldiers will wear MOS branch insignia on their left collar.

(d) On the male Army Green (Class A) jacket, the nametag will be worn on the right pocket flap, centered between the top of the pocket and the top of the button, centered on the flap and parallel to the ground.

(e) The regimental crest will be worn 1/8 inch above the top of the right pocket and centered.

(f) The ribbons will be worn 1/8 inch above the top of the left pocket, centered on the pocket, and parallel to the floor.

(g) The qualification badges will be worn 1/8 inch down from the top of the pocket and centered on the flap with 1 inch between badges if two are worn, and evenly spaced if three are worn.

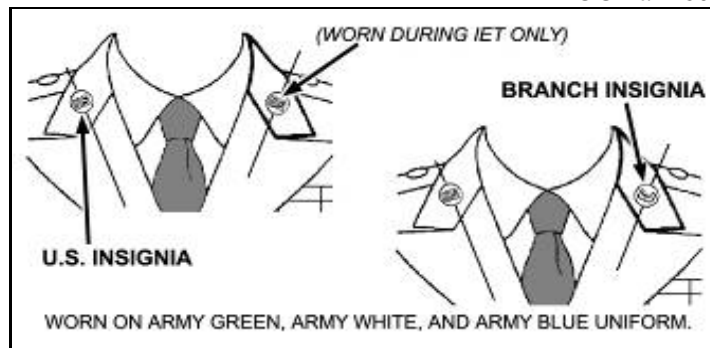

**Figure 4-7. U.S. and branch insignia, enlisted male**

- (6) U.S. and branch insignia - female.
- (a) During initial-entry training, females will wear the "U.S." insignia on both collars.
- (b) The bottom of the insignia disk will be worn 5/8 inch above the notch where the collar meets the lapel, centered between the seam and the outside edge of the collar. The "U.S." or branch insignia will be positioned parallel to the inside edge of the lapel on the Army green pantsuit jacket, and the Army green, Army white, and Army blue uniform coats (see figure 4-8).
- (c) After completing AIT or OSUT, female Soldiers will wear MOS branch insignia on their left collar.
- (d) On the female Army Green (Class A) jacket, the bottom edge of the nameplate will be 1 to 2 inches above the top of the top button, centered on the right side of the uniform and parallel to the ground.
- (e) The regimental crest will be worn 1 inch above, and centered on the nameplate.
- (f) The bottom edge of the ribbons will be parallel to the bottom edge of the name plate, and centered on the jacket.
- (g) The qualification badges will be 1 inch below and centered on the ribbons, with 1 inch between badges.
- g. Belts and buckles.**
- (1) The belt issued to Soldier's is black webbed with a nickel underplate for males and black cotton web for females.
- (2) The desert sand riggers belt will be worn with the Army combat uniform (ACU).

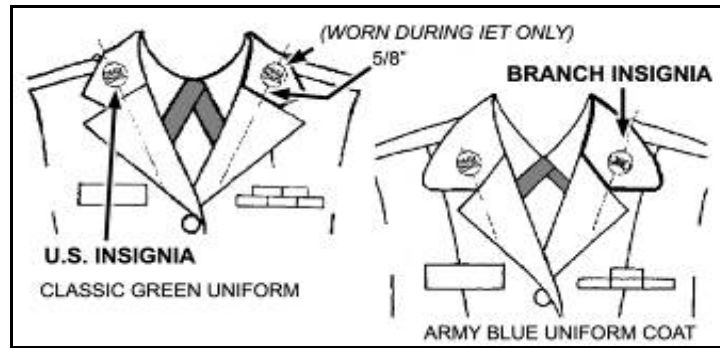

Figure 4-8. U.S. and branch insignia, enlisted female

#### 4-6. Personal hygiene

a. **The threat of illness:** Communicable diseases are caused by specific infectious organisms like viruses or bacteria transmitted from one person to another.

(1) The person who is infected may feel sick and look sick, or might carry the illness without feeling or looking sick.

(2) These diseases can rapidly degrade the medical readiness of military units and their ability to carry out their mission.

(3) They can also cause significant suffering and overwhelm the military health care system.

(4) You received vaccinations to protect you against the increased risk of these infections as a basic trainee, and you will receive additional vaccinations prior to traveling to foreign areas.

(5) Depending on the occurrence of strep in the training area, you may have received a shot of penicillin to protect you against strep.

(6) There are many communicable illnesses that do not have vaccines such as, the common cold and hepatitis C and D.

b. **Resistance to illness:** Vaccines do part of the job; the rest is up to you.

(1) You are immune to most illnesses most of the time because of your own immune system.

(2) It continues with things you do to protect yourself, like keeping yourself and your environment clean; wearing a clean uniform appropriate for the season; and avoiding contact with persons who are ill.

c. **Immediate threats to your health:** Do not take chances with your health. If in doubt, get medical help.

(1) Injuries that *pose a threat* to your health or life are:

(a) Any eye injury.

(b) Any human or animal bite that breaks the skin.

(c) Allergic reaction to an insect bite, chemicals, or medications.

(d) Bleeding that cannot be stopped.

(e) Burns, including severe sunburn.

- (f) Feeling very hot and/or confused after being out in the heat.
- (g) Exposure to cold temperatures and you think you may have a cold injury.
- (h) If you experience any of these, report to your drill sergeant immediately to get medical care.
- (2) Other symptoms of illnesses that can threaten your health or life include:
  - (a) Tightness, pressure, or pain in your chest that spreads to your neck, jaw, arm, or back.
  - (b) Shortness of breath, or wheezing while resting.
  - (c) Difficulty breathing, or the feeling of choking.
  - (d) Coughing up blood.
  - (e) Difficulty speaking, swallowing, or opening your mouth.
  - (f) Stiff neck with fever.
  - (g) Sudden loss of vision.
  - (h) Very bad pain anywhere on your body.
  - (i) Weakness and dizziness.
  - (j) Blood in your urine or brown urine.
  - (k) Vomiting up blood or what looks like coffee grounds.
  - (l) Blood in your stool or black, tar-like stools.
  - (m) You feel like you might hurt yourself or others.
  - (n) If you experience any of these symptoms, report to your drill sergeant immediately to get medical care.

**d. Take care of your skin and hair.**

- (1) Regular bathing with soap and water is important for both cleanliness and personal appearance.
- (2) Bathing prevents hygiene-related diseases such as scabies, ringworm, athlete's foot, skin infections, and pink eye.
- (3) You should especially wash your hands, face and ears, armpits, groin, and feet.
- (4) In addition to washing your skin regularly you should:
  - (a) Wash your hair at least twice a week.
  - (b) Shave daily.
  - (c) Avoid sharing combs or razors with others.

**e. Wash your hands regularly.**

- (1) Normally your immune system protects you against invasion by bacteria, viruses, and parasites.
- (2) However, if your hands become contaminated with these organisms and you put them up to your nose or mouth, disease germs can invade your body and cause an infection.
- (3) Many aspects of basic training can make you more vulnerable to respiratory illnesses, including close contact with other Soldiers.
- (4) The physical and psychological stresses of military training can make you more vulnerable to illness.
- (5) In addition, your immune system may not be ready to withstand the new organisms you are exposed to when first brought together as a group.

## TRADOC Pam 600-4

(6) Almost 90 percent of Soldiers get symptoms of respiratory illness at some point during basic training.

(7) In most cases, these illnesses are mild and trainees are able to continue training, but sometimes they progress to worse infections like pneumonia or meningitis.

(8) By washing or sanitizing your hands you can destroy these organisms and avoid getting sick from respiratory illnesses and diarrhea.

(9) You cannot see the organisms on your hands but they can make you very ill.

(10) It takes soap and water or alcohol-based sanitizer to remove them.

(11) Washing your hands regularly is the single most important action you can take to keep from getting sick.

(a) The most important times that hands should be washed or sanitized are:

- After using the latrine.
- Before eating or handling food.
- After sneezing or blowing your nose.

(12) It is important to practice good hygiene habits when you are in basic training, because it will become more difficult to wash your hands and bathe regularly when you are in the field or deployed.

### f. **Brush and floss your teeth.**

(1) Brush in the morning and before going to bed.

(a) Use a gentle circular motion.

(b) Take about 2 minutes to do a thorough job.

(c) Brush your tongue for fresh breath.

(2) Floss at least once a day.

(a) Use 18 inches of floss.

(b) Gently slide the floss between your teeth.

(c) Use a different area of the floss for each space.

### g. **Take care of your feet and nails.**

(1) Athlete's **foot** is caused by a fungus that lives in damp, warm, and dark areas like shower rooms, rubber boots, and old running shoes.

(a) Athlete's foot usually looks like little blisters between the toes.

(b) These can pop, causing itching and little sharp pains.

(c) The skin might also crack or look scaly.

(d) You can get athlete's foot from walking barefooted on unclean facilities and not washing your feet.

(e) The symptoms include itching, flaking, and cracking between toes or on bottom of feet.

(2) Prevention of Athlete's foot.

(a) Wear shower shoes while taking showers and when walking on the floor.

(b) Use a towel to dry thoroughly between your toes.

(c) Wear clean dry socks; never wear another Soldier's socks.

(d) Clean the showers and latrine floors daily.

- (e) Sprinkle foot powder in your socks to help absorb the moisture.
  - (f) Remove the inserts from your boots at night to prevent fungus from growing.
  - (g) If you get athlete's foot, you need an anti-fungal solution or cream to treat it.
  - (h) Wear one pair of boots one day and change to your other pair the next day.
- (3) Ingrown **toenails** are caused by a combination of tight shoes and trimming the toenails down to the edge of the nail. Symptoms include tenderness, swelling, sharp pain, redness, and discharge.
- (4) Prevention of ingrown toenails.
    - (a) You can prevent ingrown toenails by trimming nails straight across every two weeks (see figure 4-9).
    - (b) Seek medical attention for treatment.
    - (c) Surgery may be necessary to remove the nail from the skin.
- h. **Prevent blisters.** Blisters are caused by friction from tight fitting shoes, breaking in new boots, and road marches.
- (1) Symptoms are redness and tenderness of the skin.

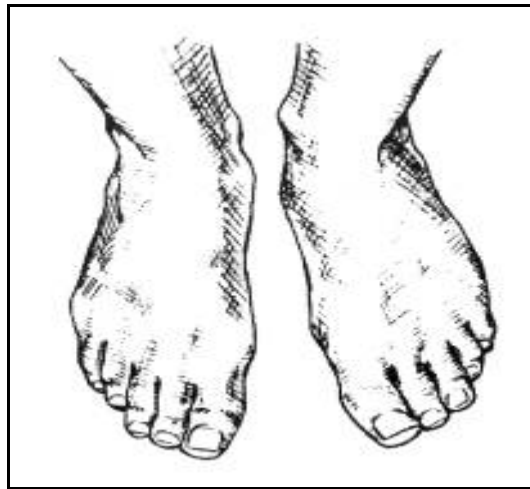

**Figure 4-9. Trimming of toenails**

- (2) All blisters cannot be prevented, but they can be minimized.
- (3) Proper fitting boots; tight fitting, clean, dry socks free of excessive wear; second skin (mole skin) on "hot spots;" knee-high nylons; and good personal hygiene will help reduce chances of getting a blister.
- (4) Wear work gloves if working with equipment that you will be doing repetitive movements, such as raking or shoveling.
- (5) To treat a blister:
  - (a) Wash with a mild soap and water and keep your skin clean and dry. Apply a topical anti-biotic ointment to prevent infection.

TRADOC Pam 600-4

- (b) Cover with bandage or second skin to prevent from opening.
- (c) **DO NOT** purposely open a blister.
- (d) If blister opens, treat as you would any open cut.
- (e) Always leave the top skin of a drained blister.
- (f) Pulling off the top layer of skin can damage the new skin underneath and cause infection.

i. **Take care of yourself in an austere environment.**

- (1) In a deployed environment you will frequently not have access to hot or running water.
- (2) It is still important to wash frequently with soap and water, paying particular attention to armpits, groin area, face, ears, hands, and feet.
- (3) A canteen of water can be used for a “bird bath” by pouring a small amount of water onto the cloth or hand, washing the skin, and rinsing with water poured into the hand or with a rinsed cloth.
- (4) Use skin cleaning wipes if available.

j. **Use a deep-breathing exercise to fall asleep.**

- (1) In basic training, you will have the opportunity for 7 hours of continuous sleep per night (unless you are scheduled for duty such as fireguard or charge of quarter’s runner).
- (2) During field training, the length of the training day and time for sleep will vary based on training requirements.
- (3) Your commander will ensure that the schedule allows sufficient time for rest during field training.
- (4) When you have the opportunity to rest or sleep, follow these guidelines:
  - (a) To fall asleep at night, breathe in deeply and slowly, expanding both the abdomen and chest.
  - (b) Hold for 5 seconds, and then breathe out slowly and completely.

k. **Fueling the body for optimal performance.**

- (1) As a Soldier, you are expected to achieve and maintain a high level of fitness for operations in combat. This fitness is not only achieved by your training, but also by how you fuel your body. Fueling with the wrong foods will lead to mental and physical fatigue and could play a large part in injuries and illnesses. The right kinds of food can be found in Army dining facilities and in the civilian world—optimal fueling requires a little knowledge, a little restraint, and a dedication to the Army Ethos that you have chosen.
- (2) What **should you load onto your tray?** General guidelines of what your tray should be loaded with are to have ½ of your plate full of a variety of fruits and vegetables, ¼ of your plate composed of complex carbohydrates (starches), and ¼ of your plate in the form of protein. Think in terms of the following:

- (a) **Energy.** Fuel with complex carbohydrates like whole wheat breads, pasta, and cereals; brown rice, and potatoes. Avoid simple sugars (sucrose, high-fructose corn syrup) that may cause a rise in energy, followed by a crash. Some fat (nuts, unsaturated oils) is

necessary in the diet to provide some energy and store vitamins, but limit intake.

(b) **Muscles.** Fuel with lean meats like (broiled or baked) fish, turkey, or chicken; eggs whites, and skim milk.

(c) **Bones.** Fuel with skim milk, low-fat chocolate or white milk, yogurt, or calcium-fortified juices.

(d) **Performance, repair, and growth.** Fuel with a variety of fruits and vegetables to obtain the minerals and vitamins necessary for optimal performance. Choose a variety of colors (red, yellow, orange, green) to ensure a wide spectrum of nutrients. Choose high-fiber foods to keep the body on “go”.

(e) **Cooling.** In dining facilities, choose nutrient dense fluids like skim milk, fruit juices, or vegetable juices. Vegetables and fruits also contain high levels of water. Leave the energy drinks for field training.

(3) **Basic guidelines include:**

(a) Fuel with a variety of foods.

(b) Practice moderation in fueling with fried foods, alcohol, or high calorie “comfort” foods.

(c) Try not to avoid meals.

(d) The brain and muscles run on carbohydrates—do not starve them.

(e) To lose weight, decrease calories while increasing exercise and activity. Keep the proportion of nutrients the same and do not starve the body. Fuel to lose! To gain weight, slightly increase calorie consumption while starting a resistance-training program. You want to gain muscle, not fat.

1. **Protect your hearing.**

(1) Survival on the battlefield could depend on your ability to hear.

(2) Hearing loss caused by noise is painless, progressive, permanent, and preventable.

(3) Insert your earplugs correctly whenever instructed to wear them.

(4) Don’t lose your earplugs.

(5) If you lose your earplugs, notify your drill sergeant immediately.

#### **4-7. Field sanitation and preventive medicine fieldcraft**

a. **Personal protection items.** Every Soldier should be issued and maintain a supply of personal protection items while they are training or while they are deployed. These items include:

(1) Lip balm protects lips from cracking/chapping during weather extremes (cold, heat, and in sustained windy conditions).

(2) Insect repellent, personal (DEET - containing) are the only repellants recommended by the Army for use by Soldiers in garrison and in the field.

(a) Apply insect repellent every 8 hours (more frequently if a Soldier is performing activities that result in significant sweating, or allows the repellent to wash off during waterborne operations).



## TRADOC Pam 600-4

(b) These repellants protect Soldiers from insects like mosquitoes, sand flies, and filth-flies; from arthropods such as ticks and fleas; and from spiders.

(c) All of these "bugs" can transmit diseases to Soldiers that can make them combat ineffective.

(d) Once a Soldier becomes ill, medics/doctors must treat the illness with special medications.

(e) If untreated, some of these diseases can result in death.

(3) Hand sanitizing gel is an acceptable substitute Soldiers can use to clean their hands when soap and water are either unavailable or impractical.

(a) These gels are over 99 percent effective in killing germs (bacteria and viruses) that can cause respiratory illness (sinus infections, sore throats, pneumonia) and gastrointestinal diseases (vomiting, diarrhea, and dysentery).

(b) Most of these illnesses can render a Soldier combat ineffective and, if serious, can result in hospitalization.

(4) Sunscreen lotions protect Soldiers from the sun's ultraviolet rays that can cause sunburn, dehydration, and skin cancer.

(a) Use these lotions on sun-exposed body parts whenever a Soldier spends more than 15 minutes at a time in sunlight (especially in desert and high mountain areas).

(b) When the complete Army combat uniform, /desert combat uniform is worn, only the hands/wrists and neck/face/ears require protection.

(5) Foot powder is designed to keep feet dry when Soldiers are spending significant amounts of time training outdoors. These powders also help prevent foot fungus (athlete's feet) and blisters when used properly

### b. **Importance of preventive medicine measures.**

(1) Historically, only 20 percent of all hospital admissions resulting from U.S. military conflict were from combat injuries.

(2) The other 80 percent were from diseases and non-battle injuries.

(3) These statistics point to the importance of following standard field hygiene measures.

(4) As a Soldier, you are going to be asked to train and fight in some of the harshest conditions imaginable.

(5) You must perform your duties in the heat and in the cold.

(6) Environment can be your enemy. It can take you out of the fight just as fast as enemy contact.

(7) As a Soldier, you must know how to treat these injuries. More importantly, though, you must be able to prevent them.

(8) Preventive medicine measures are simple, common sense actions that any Soldier can perform for protection against cold weather conditions, heat injury, insect-borne disease, intestinal disorders known as diarrhea and dysentery, and hearing loss.

(9) It is each individual's responsibility to maintain good health and use preventive medicine measures to reduce time lost due to disease and non-battle injuries.

c. **Reasons for Soldier vulnerability.**

(1) Harshness of the environment.

(a) Harsh environments are a part of military operations.

(b) Soldiers must be prepared to live and fight in deserts, jungles, and the Arctic.

(2) Natural immune defenses are reduced by exposure and fatigue.

(a) Our immune defense mechanisms operate efficiently to protect us against disease and climatic injury and are dependent upon our overall well-being.

(b) When you are placed in high stress situations such as climatic changes, sleep deprivation, and irregular meals, you become more susceptible to illness and combat stress.

(3) Breakdowns in basic sanitation.

(a) While in garrison, clean water and proper waste disposal are rarely subjects of interest or concern to most Soldiers.

(b) While in the field, and especially when wearing Mission Oriented Protection Posture (MOPP) gear, things change.

(c) Even the most common tasks such as changing socks, using the latrine, or washing hands become challenges and daily concerns.

(d) When basic personal hygiene practices are ignored or forgotten, Soldiers will become ill and unable to help their unit accomplish its mission.

d. **Operating in hot weather.**

(1) The physiologic effects of heat exposure include:

(a) **Heat load.**

- Exposure to high environmental temperature produces heat stress in the body.

- As the body attempts to compensate, physiological strain results.

- This strain, usually in combination with other strains caused by work, dehydration, and fatigue, may lead to heat injury.

- Environmental conditions that influence the heat equilibrium of the body and its physiologic adjustments include air temperature; the temperature of surrounding objects; vapor pressure of water in the air (humidity), and air movement.

(b) **Heat relief.**

- The body rids itself of heat normally through the skin and by exhaled breath.

- Some heat is discharged by radiation from the skin, but the body relies mostly on evaporation of sweat from the skin to cool.

- The adverse impact of high environmental temperature and humidity can be reduced by drinking enough water, wearing clothing properly, maintaining a high level of fitness, and resting after exposure to heat.

TRADOC Pam 600-4

- These measures contribute to the body's normal mechanisms for relieving its heat load.

(c) To protect against heat injury:

- **Drink sufficient amounts of water.**

- Your body needs a minimum amount of water for cooling, waste elimination, and metabolism.
- Drink water frequently.
- As you acclimatize to the heat, your requirement for water actually increases.

**NOTE:** Any attempt to "train" the body to use less water can be harmful and may lead to heat injuries.

(d) **Drink small quantities of water frequently.**

- It is better not to rely on thirst to remind you when to drink water.
- Individuals in a hot climate seldom feel thirsty enough to make up all water lost.

(e) **Drink extra water before an attack or mission.**

- Excess water in your system will help keep you physically strong and mentally sharp until the tactical situation allows time to drink again.
- Maintain excess water in your system for strength and alertness.
- Protect yourself from dehydration and heat injuries associated with wearing full chemical protective gear.
- Drink more water.
- Work and rest as your leader directs.
- Remember that heat injuries can be prevented by drinking plenty of water.
- In hot climates, the body depends upon sweating to keep it cool; therefore, water intake must be maintained to allow sweating to occur.
- Depending on the type of work and the temperature, you should drink ½ to 1 ½ canteens of water every hour (if your urine is dark yellow, you are not drinking enough water).

**CAUTION**

Hourly fluid intake should not exceed 1½ quarts. Daily fluid intake should not exceed 12 quarts.

(f) **Rest whenever possible.**

- Rest breaks give the body a chance to cool off; that is why it is important to rest whenever the tactical situation permits.
- Use rest breaks to drink water and to cool off. Work and rest in the shade if possible.

(g) **Take a cool shower.**

- Your body builds up heat when you are working in a hot environment.
- By taking a cool shower, you can help your body to release the heat and cool down.

- You reduce the risk of becoming a casualty the next time you are exposed to heat.

(h) Eat **meals and DO NOT take supplements.**

- Heavy sweating will cause salt loss from the body.
- Eating meals replaces salt.
- Eat regular meals daily to replace salt lost through heavy

sweating.

- Avoid excess intake of salt.
- Military rations contain all the salt needed.
- Avoid using salt tablets as a preventive measure.
- Take a salt solution only when directed by medical personnel.
- **DO NOT** take herbal-type medications, performance-enhancing drugs, diet supplements, or especially ephedra (contained in ma huang). These increase your risk for heat injury.

(i) Protect **your skin from exposure by:**

- Wearing your uniform properly.
- Use shade whenever possible.
- Using sunscreen creams and lotions on sun exposed skin areas.

e. **Heat injuries.**

(1) Heat cramps are caused by an imbalance of chemicals (called electrolytes) in the body as a result of excessive sweating.

(a) Signs and symptoms:

- Cramping in the extremities (arms and legs).
- Abdominal (stomach) cramps.
- Excessive sweating.

**NOTE:** Thirst may or may not occur. Cramping can occur without the Soldier being thirsty.

(b) First aid measures:

- Monitor mental status by asking simple questions, such as “what day is it?” or “who is the President?”
- Move the casualty to a cool, shady area or improvise shade if none is available.
- Loosen his clothing and boots (if not in a chemical environment).

**NOTE:** In a chemical environment, transport the heat casualty to a non-contaminated area as soon as the mission permits.

(4) Have him or her slowly drink at least one canteen full of water (the body absorbs cool water faster than warm or cold water; therefore, cool water is preferred if it is available).

- (5) Seek medical assistance should cramps continue.
- (6) Check the casualty for signs and symptoms of heat

exhaustion.

(2) Heat **exhaustion** is caused by loss of body fluids (dehydration) through sweating without adequate fluid replacement. It can occur in an otherwise fit individual who is involved in physical exertion in any hot environment (especially if the Soldier is not acclimated to that environment).

## TRADOC Pam 600-4

### (a) Signs and symptoms:

- Excessive sweating with pale, moist, cool skin.
- Headache.
- Weakness.
- Dizziness or lightheadedness.
- Loss of appetite.
- Cramping.
- Nausea (with or without vomiting).
- Urge to defecate.
- Chills (gooseflesh).
- Rapid breathing.
- Tingling of hands and/or feet.
- Confusion (not answering easy questions properly such as name, drill sergeant's name, day of the week.)

### (3) First aid measures.

(a) Monitor mental status by asking simple questions.

(b) Move the casualty to a cool, shady area or improvise shade if none is available.

(c) Loosen or remove his or her clothing and boots (unless in a chemical environment).

(d) Pour water on him and fan him. Use iced sheets, if available.

(e) Have him slowly drink at least one canteen of water.

(f) Elevate his legs.

(g) Monitor the casualty until the symptoms are gone or medical assistance arrives.

(h) Check the casualty for signs and symptoms of heat stroke.

### **WARNING**

**Heat stroke is a medical emergency that may result in death if care is delayed.**

(4) Heat **stroke** is caused when a Soldier has been exposed to high temperatures (such as direct sunlight) or been dressed in protective over garments, which causes the body temperature to rise. Heavy exertion without proper hydration can also cause a heat stroke.

(a) Higher levels of humidity, added to high heat exposure, decrease the time required to cause stroke.

(b) Heat stroke is caused by a failure of the body's cooling mechanism (which includes a decrease in the body's ability to produce sweat).

### (c) Signs and symptoms:

- The casualty's skin is red (flushed), hot, and dry.
- He may experience weakness, dizziness/ lightheadedness, confusion, headaches, seizures, nausea, and stomach pains or cramps.
- His respirations and pulse may be rapid and weak.
- Unconsciousness and collapse may occur suddenly.
- First aid measures.
  - Cool casualty immediately by:

- Monitoring mental status by asking simple questions.
- Moving him to a cool, shady area or improvising shade if none is available.
- Loosening or removing his clothing and boots (except in a chemical environment).
- Spraying or pouring water on him, fanning him to permit the coolant effect of evaporation.
- Massaging his extremities and skin, this increases the blood flow to those body areas, thus aiding the cooling process.
- Elevating his legs.
- Having him slowly drink at least one canteen full of water if he is conscious.
- Apply iced sheets if available.

**NOTE:** Start cooling casualty immediately. Continue cooling while awaiting transportation and during transport to a medical treatment facility.

(5) Medical assistance. Seek medical assistance because the casualty should be transported to an aid station or hospital as soon as possible.

(a) **DO NOT** interrupt the cooling process or lifesaving measures to seek help; if someone else is present send them for help.

(b) The casualty should be continually monitored for development of conditions that may require the performance of necessary basic lifesaving measures.

f. **Operating in cold weather.**

(1) The physiological effects of cold exposure.

(a) First, the body loses heat by radiation if the outside temperature is lower than the body's temperature.

(b) It loses heat by evaporation cooling from sweating (which is useful in hot weather but problematic in cold weather, especially when sweat trapped by clothing diminishes the insulating value of the clothing).

(c) Touching cold objects can cause heat loss by conduction (such as losing heat from your hands into a metal pole).

(d) If it is breezy outside, you can lose heat from convection (cool air blowing across skin with resultant heat loss).

(2) To protect against cold injury:

(a) **Exercise to increase blood circulation.**

- Exercising body parts increases blood circulation and helps you detect numbness.
- Tighten and relax your arm and leg muscles.
- Tighten and relax your fingers and toes.
- Use your hands to massage and warm the face.

**NOTE:** The normal response to the cold is for the blood vessels in the skin and remote parts of the extremities to constrict and conserve warmed blood for the vital organs. This makes the hands, feet, face, and ears more susceptible to cold injury. Moving large muscle groups

TRADOC Pam 600-4

through exercise can help shift blood from the central body to the periphery.

(3) **Wear layers of loose clothing.**

- (a) Avoid any tight-fitting clothing, including underwear.
- (b) Dress as lightly as possible consistent with the weather to prevent sweating and subsequent chilling.
- (c) Minimize sweating. When clothing becomes wet or dirty, it loses its ability to provide warmth.
- (d) Remove layers of clothing before doing strenuous work or when working in heated areas. This helps to prevent overheating that causes sweating.
- (e) Replace layers of clothing when your strenuous work is completed.

(f) Wet or dirty clothing adds to the cold injury process.

(g) Change into clean, dry clothing as soon as possible.

(h) Launder clothing regularly.

(4) **Change socks** to protect the feet in a cold environment.

(a) Put on dry socks during rest breaks (situation permitting) to reduce the risk of frostbite and trench foot.

(b) Keep socks clean and dry.

(c) Dry damp socks by placing them inside your shirt.

(d) Severe frostbite and trench foot can result in the loss (amputation) of hands or feet.

(e) Immersion foot and trench foot may result from exposure of the feet to wet conditions at temperatures from approximately 50° to 32° F.

**NOTE:** Inactive feet in damp or wet socks and boots or in tightly laced boots that impair circulation are even more susceptible to injury.

Ideally a Soldier should keep at least five pairs of boot socks with them when in the field.

(5) **Prevent dehydration** in cold weather by practicing the following:

(a) Continue to drink fluids such as potable water, juices, and warm, non-alcoholic beverages.

(b) The amount of additional liquids consumed depends upon the individual and the type of work being done.

(c) Drinking a sufficient amount of fluids in cold weather is as important as it is in hot weather.

(d) In cold weather, you may not realize that your body is losing fluids and salt.

(e) Sweat evaporates rapidly or is absorbed so completely by the layers of clothing that it is seldom visible on the skin.

(6) **Rest when possible** is an important preventive measure.

(a) Individuals must realize that work done while bundled in several layers of clothing is extremely exhausting.

(b) Leaders will determine appropriate work/rest cycles.

(7) **Watch your buddy.**

(a) Remind each other to do warming exercises often.

- (b) Watch for signs of cold injury such as frostbite, trench foot, and hypothermia.
- (c) Drink sufficient amounts of water.
- (d) Avoid smoking because smoking decreases blood flow to the skin.
- (e) Physical and mental fatigue contributes to apathy, which leads to inactivity, personal neglect, carelessness, and reduced heat production. In turn, these increase the risk of cold injury.
- (f) Buddies must help each other stay sharp to prevent injury.
- (8) **Wear appropriate uniform** for cold weather (see table 4-1).
  - (a) In cold weather, it is especially important to ensure your clothing and footgear is serviceable and fits properly.
  - (b) Your clothing is designed in multiple layers to allow for adjustment to the environment and your activity level.

**Table 4-1**  
**How to keep warm**

<b>TO KEEP WARM, REMEMBER THE WORD C-O-L-D</b>		
<b>C</b>	Cleanliness and Care	Socks and clothing work more effectively when clean. This is why you carry extra pairs with you to the field.
<b>O</b>	Avoid Overheating	Wearing too much clothing can cause overheating and excessive sweating, which makes clothes wet and decreases insulation. You will be instructed when to remove clothing.
<b>L</b>	Layers and Looseness	Clothing in loose layers assures air spaces to prevent heat loss. You will be instructed when to add clothing. If you notice your clothing is too tight, let your drill sergeant know.
<b>D</b>	Dry	A wet garment is a cold garment. You will be instructed to wear your water repellent items, such as wet weather ensemble or poncho, when appropriate.

- (c) You should wear enough layers to maintain body temperature but not sweat.
- (d) Dampness from sweat degrades insulation and allows heat to be lost.
- (e) For this reason, polypropylene underwear is designed to be worn next to the skin.
- (f) Gortex outer garments protect from wind/rain/snow, but **DO NOT** allow adequate evaporation of sweat, so they should not be worn during physical activity.
- (g) Protect feet.



TRADOC Pam 600-4

**NOTE:** You will carry extra pairs of socks to the field and change them when they become wet or damp. Use foot powder on your feet and in your boots. If your socks or boots are too tight, notify your drill sergeant. Wash your feet daily if possible. You will carry overshoes to the field to keep your boots dry.

(h) Protect hands.

**NOTE:** You will wear gloves and inserts when necessary to protect from wind chill and contact with cold surfaces.

- Warm hands under clothes if they become numb.
- Avoid skin contact with snow, fuel, or bare metal.

(i) Protect face and ears.

• You will be instructed when to wear your insulated cap with flaps down, your scarf, or your Balaclava to cover face and ears.

• You can warm your face and ears by covering them with your hands. **DO NOT** rub face or ears.

• You will be instructed when to use sunscreen and camouflage in the cold.

g. **Cold injuries.**

(1) Chilblain is caused by repeated prolonged exposure of bare skin at temperatures from 60° F to 32°F, or 20°F for acclimated, dry, unwashed skin.

(a) Signs and symptoms.

• The area may be acutely swollen, red, tender, and hot with itchy skin.

• There may be no loss of skin tissue in untreated cases, but continued exposure may lead to infected, ulcerated, or bleeding lesions.

(b) First aid measures.

• Within minutes, the area usually responds to locally applied body heat.

• Re-warm the affected part by applying firm steady pressure with your hands, or placing the affected part under your arms or against the stomach of a buddy.

• **DO NOT** rub or massage affected areas.

**NOTE:** Medical personnel should evaluate the injury because signs and symptoms of tissue damage may be slow to appear.

(2) **Frostbite** is the injury of tissue caused from exposure to cold, usually below 32°F depending on the wind chill factor, duration of exposure, and adequacy of protection.

(a) Individuals with a history of cold injury are likely to suffer an additional cold injury.

(b) The body parts most easily frostbitten are the cheeks, nose, ears, chin, forehead, wrists, hands, and feet.

(c) Frostbite may involve only the skin (superficial), or it may extend to a depth below the skin (deep).

(d) Deep frostbite is very serious and requires prompt first aid to avoid or to minimize the loss of parts or all of the fingers, toes, hands, or feet.

(e) Signs and symptoms.

- Loss of sensation (numb feeling) in any part of the body.
- Sudden blanching (whitening) of the skin of the affected part, followed by a momentary tingling sensation.
- Redness of skin in light-skinned individuals; grayish coloring in dark-skinned individuals.
- Blisters.
- Swelling or tender areas.
- Loss of previous sensation of pain in affected area.
- Pale, yellowish, waxy-looking skin.
- Frozen tissue that feels solid (or wooden) to the touch.

**CAUTION**

**Deep frostbite is a very serious injury and requires immediate first aid and subsequent medical treatment to avoid or minimize loss of body parts.**

- Immediate first aid measures.
  - Face, ears, and nose - cover the casualty's affected area with his and/or your bare hands until sensation and color return.
  - Hands - open the casualty's jacket and shirt.
    - Remove the casualty's arms from their jacket. (In a chemical environment, **DO NOT** loosen or remove the clothing and protective over garments.)
    - Place the affected hands under the casualty's armpits.
    - Close the jacket and shirt to prevent additional exposure.
  - Feet - remove the casualty's boots and socks if he does not need to walk any further to receive additional treatment (thawing the casualty's feet and forcing him to walk on them will cause additional pain and injury). Place the affected feet under clothing and against the body of another individual.
  - Ensure a cold injury casualty is kept warm and that he is covered (to avoid further injury).
  - Seek medical treatment as soon as possible.
  - Reassure the casualty, protect the affected area from further injury by covering it lightly with a blanket or any dry clothing, and seek shelter out of the wind.
  - Remove or loosen constricting clothing (except in a contaminated environment) and increase insulation.
  - Ensure the casualty exercises as much as possible, avoiding trauma to the injured part, and is prepared for pain when thawing occurs.
  - Protect the frostbitten part from additional injury.
  - **DO NOT** rub the injured part with snow or apply cold-water soaks.

TRADOC Pam 600-4

- o **DO NOT** warm the part by massage or exposure to open fire because the frozen part may be burned due to the lack of feeling.
- o **DO NOT** use ointments or other salves.
- o **DO NOT** manipulate the part in any way to increase circulation.
- o **DO NOT** use alcohol or tobacco because this reduces the body's resistance to cold.

**NOTE:** Remember, when freezing extends to a depth below the skin, it is a much more serious injury. Extra care is required to reduce or avoid the chances of losing all or part of the toes or feet. This also applies to the fingers and hands.

**WARNING**

**DO NOT attempt to thaw the casualty's feet or other frozen areas if he will be required to walk or travel to an aid station or hospital for treatment. The possibility of additional injury from walking is less with frozen feet than when they are thawed (if possible avoid walking). Thawing in the field increases the possibilities of infection, gangrene, or other injury.**

**NOTE:** Thawing may occur spontaneously during transportation to the medical treatment facility; this cannot be avoided.

**h. Hypothermia.**

(1) When exposed to prolonged cold weather, a Soldier may become both mentally and physically numb (thus neglecting essential tasks or requiring more time and effort to achieve them).

(2) Under some conditions (particularly cold-water immersion), even a Soldier in excellent physical condition may die in a matter of minutes.

(3) Hypothermia is the destructive influence of cold on the body. This means bodies lose heat faster than they can produce it.

(4) Hypothermia can occur from exposure to temperatures either above or below freezing, especially from immersion in cold water, wet-cold conditions, or from the effect of wind.

(5) General cooling of the entire body to a temperature below 95°F is caused by continued exposure to low or rapidly dropping temperatures, cold moisture, snow, or ice.

(6) Fatigue, poor physical condition, dehydration, faulty blood circulation, alcohol or other drug use, trauma, poor or inadequate nutrition, and immersion increase the risk for hypothermia.

(7) Remember, cold may affect the body systems slowly and almost without notice.

(8) Soldiers exposed to low temperatures for extended periods may suffer ill effects even if well protected by clothing.

(9) Signs and symptoms.

(a) **Early:**

- Shivering (an attempt by the body to generate heat).
- Pulse is faint or very difficult to detect.
- Drowsiness and mental slowness.
- Stiffness and lack of coordination.
- Slurred speech.

(b) **Moderate:**

- Glassy eyes.
- Slow and shallow breathing.
- Very weak or absent pulse.
- Increasing stiffness and lack of coordination.
- Unconsciousness.

(c) **Severe:**

- Frozen extremities.
- Irregular heart action.
- Sudden death.

## (10) First aid measures.

## (a) Early or moderate:

**CAUTION**

DO NOT expose the casualty to an open fire, as they may become burned.

- Provide heat by using a hot water bottle or canteen filled with hot water, wrapped in cloth.
- Call or send for help.
- Move casualty to a warm place.
- Immediately remove all wet clothing.
- Place casualty in dry clothing and/or sleeping bag.

## (b) Severe:

- Start rescue breathing at once, if the casualty's breathing has stopped or is irregular or shallow.
  - Warm liquids (not too hot!) may be given gradually if the casualty is conscious.
  - **DO NOT** force liquids on an unconscious or semiconscious casualty because they may choke.
  - Transport casualty on a litter.

**WARNING**

**Re-warming a severely hypothermic casualty is extremely dangerous in the field due to the possibility of such complications as re-warming, shock, and disturbances in the rhythm of the heartbeat. These conditions require treatment by medical personnel.**

**CAUTION**

**The casualty is unable to generate his own body heat. Therefore, merely placing him in a blanket or sleeping bag is not sufficient.**

(c) Immersion **foot and trench foot** are injuries that result from prolonged exposure to 32-50 deg F temperatures.

- Inactive feet in damp or wet socks and boots, or tightly laced boots which impair circulation, are even more susceptible to injury.
  - This injury can be very serious; it can lead to amputation of toes or parts of the feet.
  - If exposure of the feet has been prolonged and severe, the feet may swell so much that pressure closes the blood vessels and cuts off circulation.
  - Should an immersion injury occur, dry the feet thoroughly and transport the casualty to a medical treatment facility by the fastest means possible.
  - Signs and symptoms.
    - At first, the parts of the affected foot are cold and painless, the pulse is weak, and numbness may be present.
    - Next, the parts may feel hot and burning; shooting pains may begin.
    - In later stages, the skin is pale with a bluish cast and the pulse decreases.
    - Other signs and symptoms that may follow are blistering, swelling, redness, heat, hemorrhaging (excessive bleeding), and gangrene.
  - First aid measures are required for all stages of immersion injury.
    - Re-warm the injured part gradually by exposing it to warm air.
    - Protect the part from trauma and secondary infections.
    - Dry, loose clothing or several layers of warm coverings are preferable to extreme heat.
    - Under no circumstances, expose the injured part to an open fire.
    - Elevate the injured part to relieve the swelling.
    - Transport the casualty to a medical treatment facility as soon as possible.
    - When the part is re-warmed, the casualty often feels a burning sensation and pain.
    - Symptoms may persist for days or weeks even after re-warming.
- NOTE:** When providing first aid for immersion foot and trench foot -  
**-DO NOT** massage the injured part.  
**-DO NOT** moisten the skin.  
**-DO NOT** apply heat or ice.

i. **Preventive measures against arthropods (insects such as mosquitoes, ticks, and lice), poisonous reptiles, and plants.**

(1) Avoiding **injury**.

(a) To avoid injury from insects and insect related diseases:

- Keep sleeves down and trouser legs tucked into boots to protect from biting insects.
- Apply insect repellent to exposed skin, your ankles, and your waistline.
- Apply insect repellent to your uniform (if not treated with permethrin).
- Check yourself and your buddy for ticks twice a day.
- (b) To avoid injury from poisonous reptiles and plants:
  - Look inside sleeping bag before getting in.
  - **DO NOT** play with snakes.
- Keep sleeves down and trouser legs tucked into boots to protect from poisonous plants.
- Look inside boots before putting them on.

j. **Proper use of repellent.**

(1) The DOD Arthropod Repellent System consists of N-diethyl-m-toluamide (DEET) on the skin, plus permethrin on the uniform, plus wear of the uniform. This combination provides Soldiers total protection from biting insects that can transmit disease.

(2) Extended duration arthropod repellent skin lotion (DEET lotion) is a preparation that can be used on the skin.

(3) Repellent should be applied to exposed areas of skin including the face, ears, neck, arms, and hands.

**CAUTION**

Repellent will NOT be applied to eyes, lips, and sensitive skin.

(4) Apply DEET repellent skin lotion two inches under the edges of the Army combat uniform, to include the wrists, ankles, and waistline.

(a) Apply to the ankles to prevent insects from creeping between the uniform and boots.

(b) Blouse the uniform inside the boots to hinder insects getting inside the clothing.

(c) Keep the repellent skin lotion away from flame or excessive heat and always wipe hands after application.

(d) Repeat application of repellent skin lotion every six hours during strenuous activity and soon after any activity (such as stream crossing) that washes away the repellent.

(e) Read the label on the insect repellent for directions and precautions before use.

**NOTE:** Wearing after-shave lotion or cologne in the field attracts biting or stinging insects. Do not use these items during field operations.

(f) If your uniform has not been treated with permethrin prior to issue, then you may be required to apply permethrin clothing repellent. (Use either the individual dynamic absorption kit (most effective) or aerosol treatments.)

(g) Follow the directions on the product label.

TRADOC Pam 600-4

- (h) Use only on fabric.
  - (i) Treat outside of the Army combat uniform, insect head net, and mosquito bed net.
  - (j) Treat all areas of the uniform.
  - (k) Dry clothing (Army combat uniform) thoroughly prior to wearing.
    - (l) Follow these precautions:
      - **DO NOT** apply to skin.
      - **DO NOT** treat Army combat uniforms while being worn.
      - **DO NOT** treat underwear or inside the cap.
      - Avoid breathing vapors.
      - Wear your uniform properly.
      - Tuck pant legs into the boots, roll the sleeves down, and close the collar.
        - Wear the uniform loosely.
        - Check clothing frequently.
        - Use the buddy system to check areas of your body not easily seen during self-examination.
- (5) Malaria **pills**.
- (a) Take malaria pills to protect against malaria parasites (transmitted by infected mosquitoes).
  - (b) Take these pills when directed by the commander.
- (6) Clean **and inspect yourself and your clothing**.
- (a) Cleaning and inspecting your body to protect against arthropod bites includes the following:
    - Wash yourself daily if the tactical situation permits.
    - Pay particular attention to the groin and the armpits.
    - Use the buddy system to check each other for ticks and other arthropod bites.
      - If ticks are found attached, seek medical attention.
      - Use insecticide powder, cream, or shampoo when prescribed by medical personnel.
  - (b) Proper wear of the uniform will also reduce the incidence of bites.
    - The following points will be helpful in protecting your body:
      - Wear headgear to protect the top of your head.
      - Wear a loose-fitting uniform (not tightly tailored) and repair any tears or holes.
        - When the arthropod threat is high, use the following measures for protection:
          - Blouse the pants in the boots and completely lace the boots.
          - Tuck the undershirt in at the waist.
          - Wear sleeves down.
          - Button the blouse or shirt at the neck and the wrists.
      - Clean and inspect your clothing.

- o Cleaning and inspecting your uniform provides protection against insect bites.
  - o Wash your uniform to remove arthropods and their eggs.
  - o If the situation permits, use the available military laundry service (quartermaster laundry).
  - o When laundry service is not available, scrub the uniform yourself with soap and water.
  - o The clothing seams may contain lice eggs, which will hatch after a few days.
- k. Use a **bed net when sleeping, if available and the tactical situation permits.**
- (1) Protecting yourself against biting arthropods at night includes the use of a bed net and the use of insect spray inside the bed net.
    - (a) Suspend the bed net above the sleeping area.
    - (b) Tuck the edges of the bed net under the sleeping pad or bag.
    - (c) Treat the bed net with permethrin clothing repellent.
    - (d) Spray the interior space with d-phenothrin aerosol spray insecticide.
  - (2) Keep bed nets in good repair (mend any holes) in order for the preceding measures to be effective.
  - (3) Observe the following precautions when preparing the bed net:
    - (a) Avoid breathing vapors.
    - (b) **DO NOT** use permethrin clothing repellent or d-phenothrin aerosol spray insecticide on skin.
- l. **Obtain food and water from an approved source.**
- (1) Sources of bacteria.
    - (a) Intestinal diseases spread usually through contact with infectious organisms that can contaminate improperly prepared or disinfected food and water supplies as well as in human waste.
    - (b) Our hands are exposed to many sources of bacteria such as the latrine door, friend's hands, our nose, our weapons, and many others.
  - (2) Fight **preventable illness** to keep from getting sick from illnesses carried by contaminated food and water:
    - (a) Drink water from approved sources only.
    - (b) Eat from approved sources only.
    - (c) Obtain ice only from medically approved sources.
    - (d) **DO NOT** buy food, drinks, or ice from civilian vendors unless approved by medical personnel.
    - (e) When eating in local establishments, eat only hot, cooked food.
    - (f) When eating food obtained from approved vendors, eat only foods that can be cooked or raw foods that can be washed and peeled.
    - (g) Inspect all cans and food packets prior to use.
    - (h) Discard cans with leaks or bulges.
    - (i) Discard food packets with visible holes or obvious signs of deterioration.
    - (j) **DO NOT** eat foods or drink beverages that have been prepared in galvanized containers since they could cause zinc poisoning.



TRADOC Pam 600-4

- (k) Obtain food from the dining facility when possible.
- (l) The dining facility is the best source for safe food.
- (m) Wash your hands:
  - For at least 30 seconds to prevent disease.
  - After using the latrine.
  - Before touching eating utensils or food.
  - After eating.

**NOTE: Street vendors in deployed environments are normally not approved food sources since they are not inspected by U.S. military preventive medicine or veterinary personnel. Foods consumed from street vendors can cause severe illness in U.S. troops. Foods sold by food vendors may be contaminated with night soil (fertilized with human waste - common in many countries) or improperly prepared and/or cooked.**

(3) Purify **your drinking water** if there is no approved source of drinking water:

- (a) Fill your canteen with the cleanest water available.
- (b) Add iodine tablets.
  - Add two tablets to a one-quart canteen of water.
  - Double the amount of tablets if a two-quart canteen is used.
- (c) Replace the cap.
- (d) Wait 5 minutes for the tablets to dissolve.
- (e) Shake the canteen to mix the contents.
- (f) Tip the canteen to disinfect the cap threads.
- (g) Loosen the cap.
- (h) Tip the canteen over to allow leakage around the canteen threads.
- (i) Turn the canteen right side up.
- (j) Tighten the cap.
- (k) Wait 30 additional minutes before drinking.

**NOTE:** There are alternate methods for purifying water such as chlorine ampoules, tincture of iodine, or common household bleach. If none of these purifying agents is available, boil water for 5-10 minutes.  
m. **Prevent skin infections.**

(1) Hand **washing** regularly is the best defense against germs from the soil and from objects handled by other people.

- (a) The most important times to wash your hands are:
  - After using the latrine.
  - Before touching eating utensils or food.
  - After eating.
  - After handling any item that can potentially transfer germs.
  - Frequently during the workday to keep your hands free of germs.

(2) Cleaning your hands with **hand-sanitizing gel** is an effective way to disinfect them from nearly all germs that cause illnesses. **Hand-sanitizing gel** does a better job at destroying germs than soap and water, but you must use soap and water to remove grime,

and use a grease-cutting solvent to remove grease. You should use soap and water to wash your face and to bathe the rest of your body.

(3) While in the field, deployed, or during convoy operations, you will not always have ready access to your rucksack. Carry these items with you at all times:

- (a) Bar of soap.
- (b) Washcloth/baby wipes.
- (c) Toilet paper/baby wipes.
- (d) Toothbrush and toothpaste.
- (e) Shampoo.
- (f) Hand-sanitizing gel.

(4) You can use your washcloth to wash your skin with soapy water, then wring it out and use it to rinse your skin, and let the air dry your skin.

(5) Preventing skin infections involves three simple steps:

(a) **Bathe frequently.**

- Take a full bath or shower at least once every week (when available).
- If showers or baths are not available, use a washcloth daily to wash your genital area, armpits, feet, and other areas you sweat or which become wet.
- These areas include the thighs, and for females, under the breasts.
- Use of perfumed soaps or feminine deodorants in the field can cause irritation and should not be used.
- Males should shave facial hair often enough to be clean-shaven and allow a tight fit of the protective mask.

(b) **Keep your skin dry.**

- Use foot powder on your feet.
  - This is especially important if you have had fungal infections in the past.
  - Use talcum powder for areas where wetness is a problem.
  - If talcum powder is not available, use cornstarch as a substitute.
- (c) **Change to clean clothing after a full bath or shower.**
- Loose-fitting uniforms allow for better ventilation and blood circulation.
  - Wear proper clothing for the environment.
  - Nylon and silk-type undergarments are not suitable, especially in hot weather.
  - Cotton undergarments are absorbent, and they allow the skin to dry.

n. **Proper foot care.**

(1) Foot care (**before movement**) includes taking the following steps:

- (a) Wear footgear that is, the proper type, correctly fitted, and broken in.
- (b) Wear clean socks that are free of holes or knotty darns.

TRADOC Pam 600-4

- (c) Use foot powder and clean socks.
- (d) Treat and protect blisters, pressure spots, and infections before movement.
- (2) Foot care (**during movement**) includes the following steps:
  - (a) Keep your feet as dry as possible.
  - (b) Change socks (if possible) when they become damp or wet.
  - (c) Dry socks by putting them under your shirt around your waist.
  - (d) Relieve tender pressure spots on the feet by adjusting your gear.
  - (e) Dust your feet with foot powder once or twice daily.
  - (f) Inspect your feet (if possible) at rest periods.
  - (g) Wash your feet during the noon break if possible.
  - (h) Raise your feet (if possible) while resting to help reduce congestion and swelling.
    - (i) Take care of blisters whenever time permits.
    - (j) Wash blisters and the surrounding areas with soap and water.
- (3) Seek medical treatment for painful blisters or signs of infection such as redness, throbbing, and drainage.
  - (a) Sprinkle foot powder in your socks to help absorb the moisture.
  - (b) Remove the inserts from your boots at night to prevent fungus from growing.
  - (c) If you get athlete's foot (seek medical attention), you need an anti-fungal solution or cream to treat it.
  - (d) Wear one pair of boots one day and change to your other pair the next day.
  - (e) Use boot/sock liners for road marches greater than 5 km (3.1 mi) in length to prevent blisters.
  - (f) Boot/sock liners are your military issued black dress socks worn underneath your military black boot socks.
- o. **Waste disposal.**
  - (1) **Food waste disposal.**
    - (a) Waste disposal is an important element in the protection of Soldiers' health in the field.
    - (b) Intestinal diseases are spread through contact with infectious organisms that can be spread by flies.
    - (c) Use covered containers if available to keep out pests and to prevent breeding of flies.
    - (d) Use plastic bags in the event you have dumpster-type receptacles and regular waste pick-up.
    - (e) Bury your food waste immediately if other options (burning or contract pick-up) are not available.
    - (f) Promptly burning or burying your waste helps to prevent the spread of germs by flies and other insects.
    - (g) Burying waste also helps keep unwanted animals out of your bivouac area.
  - (2) **Human waste disposal.**
    - (a) Intestinal diseases are usually spread through contact with infectious organisms that can be spread in human waste.

- (b) The method used for disposal of waste depends upon the military situation, the unit, and its location.
  - (c) Waste disposal impacts upon the health of a unit's personnel and must be done correctly.
  - (d) Recommended methods of disposing of human waste follow:
    - Use the unit latrine when available (deep pit for extended field operations).
      - Deep-pit latrines are constructed for temporary camps (intended for stays of more than 3 days).
      - These type latrines are found in some training areas and base camps.
      - They are sometimes enclosed in buildings.
    - Dig a cat hole to use for excreting waste if your unit is on the move.
      - The cat hole is dug 12 inches across and from 6 to 12 inches deep.
      - Cover it sufficiently to prevent flies from spreading germs from waste to your food and to keep unwanted animals out of your area.
      - On a march, cover the cat hole with dirt immediately after use.
    - Use a straddle trench for 1-3 day field operations.
      - Screen these latrines for privacy.
      - Dig two trenches per 100 males, and three trenches per 100 females.
    - Use individual waste collection bags (if available) on the march, on convoys, or for small groups in isolated areas.
      - It is important to seal and transport the waste with you until it can be safely burned or buried.
      - Waste collection bags are effective on convoys where it is unsafe to leave the main route.
      - Remember to sanitize your hands and any containers that are reusable when appropriate.
    - The pail latrine and the burnout latrine are similar.
      - Construct these when chemical toilets are not available, the ground is too hard, or the soil is very wet.
      - Burn out the latrine daily by adding sufficient fuel to incinerate the excrement.
      - A mixture of 1 quart (1 liter) of gasoline to 4 quarts (4 liters) of diesel oil is effective, but must be used with caution.
      - If possible, have two sets of drums, one set for use while the other set is being burned clean.
      - The contents are burned until they are dry and odorless.
      - Any remaining ash should be buried. Burn the waste daily to keep from attracting pests.
- p. **Oral hygiene.**
- (1) Good oral hygiene consists of three simple steps:

TRADOC Pam 600-4

(a) **Brush your teeth** after every meal if possible (toothpaste helps but it is not a necessity).

(b) **Use dental floss** at least once a day.

(c) **Rinse your mouth** with potable water after brushing and flossing.

(2) This care may prevent gum disease, infection, and tooth decay.

(3) **Going to the dentist** at least once a year for an examination (and treatment, as needed) can prevent serious problems.

q. **Prevent hearing loss.**

(1) To protect against hearing loss use individual measures against noise hazards:

(a) **Use protective devices** (earplugs, ear canal caps, or earmuffs) to reduce the risk of noise-related hearing loss.

(b) Earmuffs should be worn over earplugs in high steady-state noise level areas.

(c) **Use vehicle headgear** such as helicopter crew helmets and armored vehicle crew helmets when appropriate.

(d) Keep hearing protection devices (meant to be inserted into the ear canal) clean to avoid ear infections.

(e) **Avoid noise** and limit the time in noise hazardous areas to only the time necessary to perform the mission.

r. **Department of the Army smoking policies.**

(1) **Smoking policy.**

(a) The DOD has a smoke-free workplace policy.

(b) The Army has the same policy.

(c) Programs have been established to help Soldiers and family members become tobacco-free.

(2) **Effects of tobacco use.**

(a) Long-term health costs of tobacco use.

- Heart disease—leading risk for heart attack.

- Contributes to strokes and poor circulation (due to diseased blood vessels).

- Chronic lung diseases—emphysema, bronchitis.

- Cancers - lung, throat, mouth, bladder, possibly cervix.

- Osteoporosis (brittle bones).

- Increases risk in surgery and prolongs healing process.

- May decrease male fertility.

- Affects health of nonsmokers.

- Second-hand smoke linked to lung cancer, asthma attacks.

- Children exposed to cigarette smoke have more middle ear and lower respiratory infections.

- Smoking during pregnancy is associated with low birth weight and pre-term births.

- May increase risk of sudden infant death syndrome (SIDS).

- Leading cause of death in the U.S.—heart and blood vessel disease.

- (10) Leading preventable cause of death— tobacco use.

**NOTE:** Tobacco use is responsible for more deaths than all other causes (450,000 plus deaths per year). That's equivalent to two fully loaded jumbo jetliners colliding in mid-air, each day, with no survivors.

(3) **Smokeless tobacco.**

- (a) Many people believe smokeless tobacco is safer than smoking.
- (b) It is well established that smokeless tobacco of all types (chew, snuff, bandits) leads to the development of heart disease, various cancers, gum recession, and bone loss around the teeth.
- (c) Cancers of the mouth and throat are particularly deforming and deadly.
- (4) **Effect of tobacco use on Soldiers' performance and health.**
  - (a) Increases number of sick call visits.
  - (b) Increases susceptibility to upper respiratory infections (colds and flu), which may progress to pneumonia.
  - (c) Decreases readiness.
  - (d) Decreases night vision.
  - (e) Decreases hand-eye coordination.
  - (f) Decreases stamina.
  - (g) Increases cold weather injuries.
  - (h) Increases overall number of injuries.
  - (i) Leads to addiction.

**NOTE:** There are far more smoking-related deaths every year than deaths due to illicit drug use. Despite the fact that people know tobacco is bad for their health and longevity and want to give it up, it is very difficult for most to do so. The physical and emotional dependence developed with tobacco use is very great. Withdrawal symptoms are unpleasant. Often tobacco users feel jittery and irritable after a certain period of time without nicotine. These are symptoms of withdrawal! We need Soldiers who are alert, can concentrate on the task at hand and who are team players—not individuals who are easily aggravated by other people or stressful situations due to their bodies' reaction to not having tobacco.

(5) **Army Regulation 600-63, Army Health Promotion.**

- (a) Smoking is prohibited during BCT.
- (b) Smoking prohibited during AIT.
- (c) Smoking prohibited in all Army-occupied work places.
- (d) Resources available for tobacco use cessation:
- (e) Your doctor, nurse practitioner, physician's assistant (PA), primary care provider, or community health nurse.

**NOTE:** Your health care provider may be able to prescribe medication to help with your cessation effort.

- Smoking cessation programs are usually sponsored by the health care facility or the local preventive medicine service.
  - Self-help materials are available from-
    - The medical treatment facility and health care providers.
    - The preventive medicine/ community health nurse.

#### TRADOC Pam 600-4

- Various community agencies, such as the American Cancer Society Health Initiatives Department “Quit Line” (available 224 hours a day) at 1-877-937-7848 or the local public health department can offer training, counseling, free materials and information.
- (6) **The bottom line is that tobacco use detracts from readiness.**
  - (a) Using tobacco affects your ability to function when you are in the field or deployed.
  - (b) Tactical hazards include:
    - Cigarette smoke can be detected up to 300 meters down wind by the enemy.
    - The flame can be detected by enemy snipers.
    - There are possibilities of starting a fire.
    - Smoking can be hazardous to a Soldiers’ health even if it is their buddy who is smoking.
    - Long-term adverse effects of using tobacco can cause chronic diseases of heart and lungs, cancer, stroke, and high blood pressure.
    - Short-term effects can cut into your effectiveness in performing your mission. They include:
      - The enemy can find you!
      - Watering eyes.
      - Runny nose.
      - Cough.
      - Loss of smell and taste.
      - Increase in heart rate (up to 30percent).
      - More easily fatigued.
      - Elevation in blood pressure (up to 15percent).
      - Decreased appetite.
      - Diarrhea, constipation, or both.
      - Reduced stamina.

#### **4-8. Guard duty: general and special orders**

- a. One of the most important duties you will perform in the Army is guard duty. In a combat zone, an alert, cautious guard can make the difference between life and death. However, guards are important everywhere due to the terrorist threats that can occur anywhere.
- b. A guard on post is governed by two sets of orders: general orders and special orders. Special orders give details on how to perform on a particular post. General orders outline the basic responsibilities of all guards. The three general orders are:
  - (1) **General order number 1:** "I will guard everything within the limits of my post and quit my post only when properly relieved."
    - (a) This general order gives you responsibility for everything that occurs within the limits of your post while on duty.

(b) You must immediately investigate any unusual or suspicious occurrences on or near your post, provided you do not have to leave your post.

(c) You must apprehend all suspicious persons, using only necessary force to overcome resistance.

(d) If you should require relief for any purpose, you must contact the commander of the relief for instructions.

(2) **General order number 2:** "I will obey my special orders and perform all my duties in a military manner."

(a) This general order requires you to become thoroughly familiar with the special orders before you are actually posted.

(b) In addition to the special orders connected with your post, you are required to obey and carry out any orders or instructions from the commanding officer, field officer of the day, and officers and NCOs of the guard.

(c) No other persons are authorized to give orders to Soldiers on guard duty.

(d) You should pass instructions and special information to your relief when appropriate.

(e) An example is: You are a guard on duty at an ammunition dump and discover a hole in the fence, which you report to the commander of the relief. You also pass the information on to your relief so that special attention can be paid to that part of the fence until the hole is repaired.

(f) General order number 2 also requires you to perform your duties in a military manner, to be courteous to all, and to speak to no one, except in the line of duty.

(g) You must maintain an erect and Soldierly bearing, carrying your weapon as instructed by the commanding officer or commander of the guard.

(h) You must salute individuals according to FM 3-21.5.

(i) The special orders will tell you whether and when to challenge.

(3) **General order number 3:** "I will report violations of my special orders, emergencies, and anything not covered in my instructions to the commander of the relief."

(a) General order number 3 requires you to report all special order violations and emergencies.

(b) In case of a fire on or near your post, call fire post number

(c) You should alert the occupants if the fire is in an occupied building. Also, give the alarm or make sure one is given.

(d) If possible, extinguish the fire and help direct fire fighting apparatus to the fire.

(e) If a disturbance occurs that requires assistance, call guard post number \_\_\_\_\_(fill in the blank).

(f) If the danger is great, fire your weapon into the air three times in rapid succession.



**4-9. Guard duty: interior and exterior**

a. **Interior guard:** An interior guard is set up by the commander of the military installation to protect property and to enforce specific military regulations.

(1) The main guard is a combination of patrols and fixed guard posts.

(2) Special guards are used to protect parks, boats, aircraft, and other places or property.

(3) All interior guards must memorize, understand, and comply with the three general orders.

(4) When you, as a guard, are asked to state your orders by an inspecting officer, the proper answer is: "Sir/Ma'am, my orders are of two classes: general and special. My general orders are, Number 1: I will guard everything within the limits . . .," continuing until stopped by the officer or until you recite all the general orders. You should be able to answer any questions concerning the special orders for your post.

(5) The commanding officer prescribes uniform, arms, and equipment for guard mounts. If armed, you must have completed training with the weapon to be used on guard duty.

(6) The sergeant of the guard will organize the Soldiers making up the guard into a formation, using commands and movements described in FM 3-21.5, paragraph 7-7. The commander of the guard then prepares the guards for inspection.

(7) The officer of the day inspects the guards and orders those found unsatisfactory to fall out to the rear of the formation and await further instructions. The guards then move to the guardhouse, and the commander of the first relief prepares the relief to be posted.

(8) At the appropriate time, the old guard will be relieved by the new guard. The changing of the guard is accomplished through a ceremony conducted by the two commanders.

b. **Exterior guards:** Exterior guards are not as formal and restricted as interior guards are.

(1) Examples of exterior guards are lookouts, listening posts, outposts, certain patrols, and other guards in combat zones and field training, and guards outside the limits of a military installation.

(2) Exterior guards perform their duties according to special orders and instructions.

**4-10. Guard duty: reacting to an inspecting officer**

a. When a guard on duty is approached by an inspecting officer, these steps are followed:

(1) Stop walking and assume a position of attention.

(2) When the inspecting officer approaches, render a proper hand salute.

(3) When the salute is returned, execute order arms.

- (4) Remain at attention.
- (5) The inspecting officer will command, "At ease."
- (6) The inspecting officer will ask questions pertaining to the general orders.
- (7) When finished with the inspection, the inspecting officer will say, "Carry on."
- (8) Assume a position of attention and render a proper hand salute, holding it until it is returned.
- (9) Resume walking your post.

**4-11. Guard duty: challenging unknown persons (night) and summoning the commander of the relief**

- a. The following steps are carried out when challenging unknown person (night) and summoning the commander of the relief:
  - (1) Upon seeing or hearing an unknown person, come to port arms.
  - (2) Issue the command "Halt." (Person halts.)
  - (3) Call out "Who is/goes there?" Unknown person identifies him/herself.
  - (4) State "Advance to be recognized."
  - (5) Command "Halt," when the person can be seen but not closer than 2 to 3 meters away.
  - (6) Say "State your business." Unknown person states reason for presence in guarded area.
  - (7) Require the unknown person to place their identification on the ground and move back six steps.
  - (8) Check the identification while keeping the person under observation.
  - (9) If the ID and authorization do not match, move to the phone and call the commander of the relief while keeping the person under observation.
  - (10) Release the person to the commander of the relief and explain that their identification and authorization do not match.

**THIS PAGE LEFT BLANK INTENTIONALLY.**

## Chapter 5 Rifle Marksmanship

### 5-1. Rifle marksmanship: fundamentals

- a. The Soldier must understand the five key rifle marksmanship fundamentals before approaching the firing line.
  - (1) Establish a **steady position** that allows observation of the target.
  - (2) Apply proper **aiming** of the rifle at the target by aligning the sight system.
  - (3) Apply proper **breath control** without disturbing the alignment.
  - (4) Apply proper **trigger squeeze** without disturbing the alignment.
  - (5) Follow-through by keeping your finger on the trigger all the way through the rear and releasing the trigger after the recoil has stopped (2 sec).
- b. When expanded with additional techniques and information, these rifle marksmanship skills will aid the firer in achieving target hits under many conditions.
- c. Applying the five fundamentals rapidly and consistently is called “the integrated act of firing.”
  - (1) **Steady position.** When the Soldier approaches the firing line, he should assume a comfortable, steady firing position in order to hit targets consistently. The time and supervision each Soldier has on the firing line are limited. Therefore, he must learn how to establish a steady position during dry-fire training. The firer is the best judge as to the quality of his position. If he can hold the front sight post steady through the fall of the hammer, he has a good position. The steady position elements (see figure 5-1) are as follows:

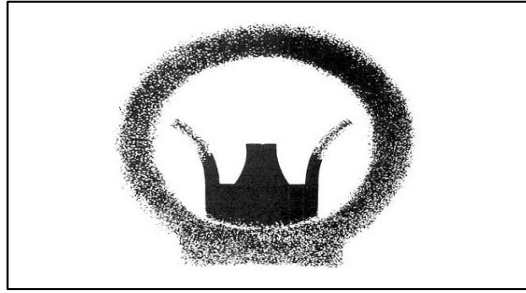

**Figure 5-1. Steady position elements**

- (a) **Non-firing handgrip.** Hand forms a “U” by placing the thumb and forefinger over the handguard.
  - (b) **Rifle butt stock placed in pocket of firing shoulder.**
  - (c) **Firing hand grip.** Firing hand forming a “V” sitting high on the pistol grip; slight rearward pressure
    - The forefinger is placed on the trigger so that the lay of the rifle is not disturbed when the trigger is squeezed.
    - A slight rearward pressure is exerted by the remaining three fingers to ensure that the butt of the stock remains in the pocket of the shoulder, minimizing the effect of recoil.
  - (d) **Firing elbow placement.** The location of the firing elbow is important in providing balance.
    - The exact location, however, depends on the firing/ fighting position used. For example, kneeling, prone, sitting, or standing.
    - Placement should allow shoulders to remain level.
    - Keep the magazine firmly on the ground.
  - (e) **Non-firing elbow:** ensure elbows are firmly on the ground stabilizing the weapon;
  - (f) **Head:** the head is erect with proper cheek to stock contact for every round.
- (2) **Aiming.** open both eyes, scan sector, acquire target; close non-firing eye, focus is on front of sight post; tip on front sight post is center of rear hole; eye is directly lined up with center of rear sight
- (a) It involves placing the tip of the front sight post in the center of the rear sight aperture (see figure 5-2).

(b) Any alignment error between the front and rear sights repeats itself for every 1/2 meter the bullet travels.

(c) For example, at the 25-meter line, any error in rifle alignment is multiplied 50 times. If the rifle is misaligned by 1/10 inch, it causes a target at 300 meters to be missed by 5 feet.



**Figure 5-2. Correct sight picture**

(3) **Focus of the eye.** A proper firing position places the eye directly on line with the center of the rear sight.

(a) When the eye is focused on the front sight post, the natural ability of the eye to center objects in a circle and to seek the point of greatest light (center of the aperture) aid in providing correct sight alignment.

(b) For the average Soldier firing at combat-type targets, the natural ability of the eye can accurately align the sights.

(c) Therefore, the firer can place the tip of the front sight post on the aiming point, but the eye must be focused on the tip of the front sight post.

(d) This causes the target to appear blurry, while the front sight post is seen clearly.

(e) Two reasons for focusing on the tip of the front sight post are:

- Only, a minor aiming error should occur since the error reflects only as much as the Soldier fails to determine the target center. A greater aiming error can result if the front sight post is blurry due to focusing on the target or other objects.

- Focusing on the tip of the front sight post aids the firer in maintaining proper sight alignment (see figure 5-2).

(4) **Sight picture.** Once the Soldier can correctly align his sights, he can obtain a sight picture.

(a) A correct sight picture has the target, front sight post, and rear sight aligned.

(b) The sight picture includes two basic elements: sight alignment and placement of the aiming point.

- Placement of the aiming point varies, depending on the engagement range.

• Figure 5-3 shows a Soldier obtaining a correct sight picture as it relates to figure 5-2. The aiming point is the center of mass, and the sights are in perfect alignment. This is a correct sight picture.



**Figure 5-3. Prone unsupported showing correct sight alignment**

(5) **Front sight.** The front sight post is vital to proper firing and should be replaced when damaged.

(a) The post should be blackened anytime it is shiny since precise focusing on the tip of the front sight post cannot be done otherwise.

(b) Two techniques that can be used are the carbide lamp and the burning plastic spoon.

(6) **Aiming practice.** Aiming practice is conducted before firing live rounds.

(a) During day firing, the Soldier should practice sight alignment and placement of the aiming point.

(b) This can be done by using training aids such as the M15A1 aiming card and the Riddle sighting device.

(7) **Breath control.** As the firer's skills improve and as timed or multiple targets are presented, he must learn to hold his breath at any part of the breathing cycle. Two types of breath control techniques are practiced during dry fire:

(a) The first is the technique used during zeroing and when time is available to fire a shot (see figure 5-4, top graph).

- There is a moment of natural respiratory pause while breathing when most of the air has been exhaled from the lungs and before inhaling.

- Breathing should stop after most of the air has been exhaled during the normal breathing cycle.

- The shot must be fired before the Soldier feels any discomfort.

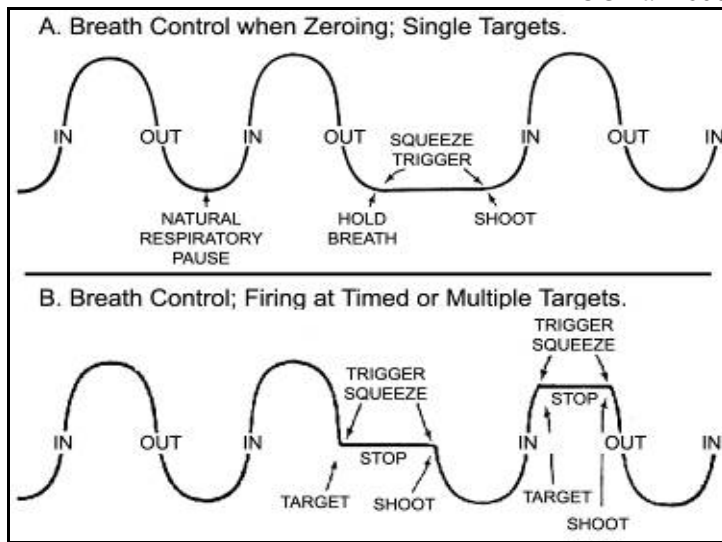

**Figure 5-4. Breath control**

(b) The second breath control technique is employed during rapid fire (short-exposure targets [see figure 5-4, bottom graph]). Using this technique, the Soldier holds his breath when he is about to squeeze the trigger.

(8) **Trigger squeeze.** Any sudden movement of the finger on the trigger (see figure 5-5) can disturb the lay of the rifle and cause the shot to miss the target. The precise instant of firing should be a surprise to the Soldier.



**Figure 5-5. Trigger squeeze**



## TRADOC Pam 600-4

(a) The Soldier's natural reflex to compensate for the noise and slight punch in the shoulder can cause him to miss the target if he knows the exact instant the rifle will fire.

(b) The Soldier usually tenses his shoulders when expecting the rifle to fire, but it is difficult to detect since he does not realize he is flinching.

(c) When the hammer drops on a dummy round and does not fire, the Soldier's natural reflexes demonstrate that he is improperly squeezing the trigger.

(d) A novice firer can learn to place the rifle in a steady position and to correctly aim at the target if he follows basic principles.

(e) If the trigger is not properly pulled, the rifle is misaligned with the target at the moment of firing.

(f) The trigger finger (index finger on the firing hand) is placed where it naturally lies.

- The trigger finger must pull the trigger smooth, slow, steady to the rear so that the hammer falls without disturbing the lay of the rifle.

- When a live round is fired, it is difficult to see what effect trigger pull had on the lay of the rifle.

- Therefore, it is important to experiment with many finger positions during dry-fire training to ensure the hammer is falling with little disturbance to the aiming process.

(g) As the firer's skills increase with practice, he needs less time spent on trigger squeeze.

(h) Novice firers can take five seconds to perform an adequate trigger squeeze. As skills improve, he can squeeze the trigger in a second or less.

(i) The proper trigger pull should start with a smooth, slow, steady to the rear pull on the trigger during the initial aiming process.

(j) The firer applies more pressure after the front sight post is steady on the target and he is holding his breath.

(9) Follow-through. Keep finger on the trigger all the way to the rear; ease the trigger forward without taking your finger off, only after the recoil has stopped (2 sec).

### **5-2. Rifle marksmanship: firing positions combat applicable training course (CATC)**

a. All firing positions are taught during basic rifle marksmanship training.

b. During CATC training, the basic firing positions used are the prone position, the kneeling position, and the seated position. IET Soldier's qualify from the prone supported, prone unsupported, and kneeling firing positions.

c. All offer a stable platform for firing the rifle and are the positions used during basic record fire.



**Figure 5-6. Prone unsupported position**

d. Prone unsupported position. This firing position (see figure 5-6) offers another stable firing platform for engaging targets.

(1) To assume this position, the Soldier faces his target, and drops to the ground, breaking his fall with the butt of the weapon.

(2) Legs are spread apart, toes pointing out assuming a natural point of aim.

(3) Both elbows are placed on the ground to support the upper body with the magazine offering stabilization.

(4) The firing hand is placed on the pistol grip; the non-firing hand is placed on the upper handguard.

(5) Elbow and knee pads can be worn to relieve pressure and IBA induced pain in these areas. The butt of the weapon should be placed between the SAPI plate and bicep to help stabilize the weapon and absorb recoil.



**Figure 5-7. Kneeling firing position**

(6) This position (see figure 5-7) offers another firing platform for engaging targets.

(a) To assume the kneeling firing position, the Soldier keeps his left foot in place, steps back with the right foot, then drops to the right.

## TRADOC Pam 600-4

(b) He places the left non-firing hand on the upper handguard with the upper arm (triceps) on the left knee for support.

(c) The right hand is placed on the pistol grip with the butt of the weapon between the SAPI plate and bicep to help stabilize the weapon and absorb recoil.

(d) The ball of the right foot should rest firmly on the ground so the Soldier can sit back with his buttock on the heel. Relaxing and leaning forward into the position can help absorb recoil.

(e) The butt of the weapon should be placed between the SAPI plate to help stabilize the weapon and absorb recoil.



**Figure 5-8. Seated firing position**

(7) Seated position. This firing position (see figure 5-8) offers another firing platform for engaging targets.

(a) To assume the sitting position the Soldier assumes a seated position with legs tucked.

(b) He places the left non-firing hand on the upper handguard with the elbows on both knees for support.

(c) The right hand is placed on the pistol grip with the butt of the weapon between the SAIP plate and bicep to help stabilize the weapon and absorb recoil.

### **5-3. Rifle marksmanship: positions of the coach**

a. The coach constantly checks and assists the firer in applying marksmanship fundamentals during firing.

b. He observes the firer's position and his application of the steady position elements.

c. The coach is valuable in checking factors the firer is unable to observe for himself and in preventing the firer from repeating errors.

d. During an exercise, the coach should be positioned where he can best observe the firer when he assumes position.

e. He then moves to various points around the firer (sides and rear) to check the correctness of the firer's position.

- f. The coach requires the firer to make adjustments until the firer obtains a correct position.
- g. When the coach is satisfied with the firing position, he assumes a coaching position alongside the firer.
- h. The coach usually assumes a position like that of the firer, which is on the firing side of the Soldier (see figure 5-9).



**Figure 5-9. Prone position of coach (right-handed firer)**

#### **5-4. Rifle marksmanship: checklist for the coach**

- a. In order to determine and eliminate rifle and firer deficiencies, the coach checks to see that the:
  - (1) Rifle is cleared and defective parts have been replaced.
  - (2) Ammunition is clean, and the magazine is properly placed in the pouch.
  - (3) Sights are blackened and set correctly for small (day) aperture vs. large (limited visibility).
- b. The coach also observes the firer to see:
  - (1) position elements.
  - (2) If he properly loads the rifle.
  - (3) If he obtains the correct sight alignment (with the aid of an M16 sighting device).
  - (4) If he holds his breath correctly (by watching his back at times).
  - (5) If he applies proper trigger squeeze, determines whether he flinches or jerks by watching his head, shoulders, trigger finger, and firing hand and arm.
  - (6) If the firer is tense and nervous, the coach has him breathe deeply several times to relax.
- c. Supervisory personnel and peer coaches correct errors as they are detected. If many common errors are observed, it is appropriate to call the group together for more discussion and demonstration of proper procedures and to provide feedback.

### 5-5. Weapons status

See figure 5-10 for weapons status.



Figure 5-10. Weapons status

**5-6 Weapons clearing**

See figure 5-11 for weapons clearing

**M16/M4Series Rifles****Clear the rifle.**

- a. Attempt to place the selector lever on SAFE. If the weapon is not cocked, the lever cannot be placed on SAFE.
- b. Remove the magazine from the rifle, if there is one present.
- c. Lock the bolt open
  - (1) Pull the charging handle rearward.
  - (2) Press the bottom of the bolt catch.
  - (3) Allow the bolt to move forward until it engages the bolt catch.
  - (4) Return the charging handle to the forward position.
  - (5) If the selector lever is not on SAFE, place it on SAFE.
- d. Observe the receiver and chamber to ensure positively that they do not contain ammunition.
- e. Allow the bolt to go forward by pressing the upper portion of the bolt catch.
- f. Place the selector lever on SEMI and squeeze the trigger.
- g. Pull the charging handle fully rearward and release it, allowing the bolt to go forward.
- h. Place the selector lever on SAFE.



Figure 5-11. Weapons clearing

**THIS PAGE LEFT BLANK INTENTIONALLY.**

## Chapter 6 U.S. Weapons

### 6-1. M16-series rifles and M4 series carbines description (weapons)

The M16- and the M4-series weapons (see figure 6-1) are lightweight, gas-operated, air-cooled, magazine-fed, shoulder-fired weapons. Depending on the specific weapon system, they can be fired in either automatic, three-round bursts, or semiautomatic mode. The purpose of the weapons is to provide personnel an offensive/ defensive capability to engage targets in the field. Adapter rails allow operators the capability to mount various accessories on to the M16A4 rifle and M4/M4A1 carbines.

**M16A1 rifle:** This weapon can be fired in either the semiautomatic or automatic fire mode by rotating the selector lever to the desired mode (SAFE, SEMI, and AUTO).

**M16A2/A3 rifle:** This weapon features several improvements over the M16A1. It is designed to fire either semiautomatic or a three-round burst through the use of a selector lever (SAFE, SEMI, and BURST). The M16A3 rifle has the same characteristics as the M16A2 with the exception of the selector lever (SAFE, SEMI, and AUTO). This weapon fires full automatic.

**M16A4 rifle:** This weapon features additional product improvements. It is designed to fire either semiautomatic or a three-round burst through the use of a selector lever (SAFE, SEMI, and BURST). The only changes from the M16A1/A2/A3 are the addition of the M5 rail adapter system and the detachable carrying handle.

**M4 carbine:** This weapon is a 5.56-mm, magazine-fed, gas operated, shoulder-fired weapon. It is designed to fire either semiautomatic or a three-round burst through the use of a selector lever (SAFE, SEMI, and BURST). The M4-series carbine features several modifications that make it an ideal weapon for close combat operations.

**M4A1 carbine:** This weapon is fully automatic. The M4-series carbine butt stock has four positions: closed, 1/2 open, 3/4 open, and full open. The M4 carbine becomes the M4 MWS (see figure 6-1) when the M4 rail adapter system is installed on it.

**Magazine:** A magazine may be inserted with the bolt assembly open or closed. After the selector lever is placed on SAFE, insert a loaded cartridge magazine in the magazine well and chamber a round. Face the target, place the weapon to your shoulder, and move the selector lever from SAFE to SEMI or AUTO/BURST. Align the front and rear sights with the target and squeeze the trigger. Squeezing the trigger releases the hammer, which strikes the firing pin, causing it to impact



the primer of the round. The primer ignites the propellant in the round. The gas from the burning propellant pushes the projectile along the barrel of the weapon. The rifling in the barrel causes the projectile to rotate, which provides stability during flight to the target. When the round reaches the approximate end of the barrel, expanding gases from the burning propellant pass through gas port, gas tube and into the bolt carrier assembly forcing it to the rear. This causes the bolt to extract and eject the spent cartridge case and chamber a new round.



Figure 6-1. M16- and M4-series weapon systems

**MAJOR ASSEMBLIES (M16A2 and M16A3)**

The major assemblies for the M16A2 and M16A3 are described and numbered below (see figure 6-2).

**Charging Handle Assembly (1)**—Provides initial charging of the weapon. The charging handle locks in the forward position during sustained fire to prevent injury to the operator.

**Bolt and Bolt Carrier Assembly (2)**—Provides stripping, chambering, locking, firing, extraction, and ejection of cartridges using the drive springs and projectile propelling gases for power.

**Carrying Handle (3).**

**Upper Receiver and Barrel Assembly (4)**—Provides support for the bolt carrier assembly. The barrel chambers the cartridge for firing and directs the projectile.

**Lower Receiver and Butt stock Assembly (5)**—Provides firing control for the weapon and provides storage for basic cleaning materials.

**Cartridge Magazine (6)**—Holds cartridges ready for feeding and provides a guide for positioning cartridges for stripping. Provides quick reload capabilities for sustained firing.

**Small Arms Sling (7)**—Provides the means for carrying the weapon.

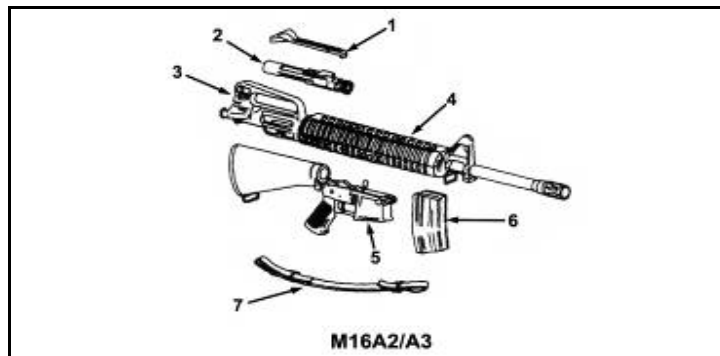

**Figure 6-2. M16A2 and M16A3 major assemblies**

**MAJOR ASSEMBLIES (M16A4 and M4/M4A1)**

The major assemblies for the M16A4 and M4/M4A1 are described and numbered below (see figure 6-3).

**Charging Handle Assembly (1)**—Provides initial charging of the weapon. The charging handle locks in the forward position during sustained fire to prevent injury to the operator.

TRADOC Pam 600-4

**Bolt and Bolt Carrier Assembly (2)**—Provides stripping, chambering, locking, firing, extraction, and ejection of cartridges using the drive springs and projectile propelling gases for power.

**Detachable Carrying Handle (3)**—May be removed for attachment of various accessories to the integral accessory mounting rail.

**Upper Receiver and Barrel Assembly (4)**—Provides support for the bolt carrier assembly. The barrel chambers the cartridge for firing and directs the projectile.

**Lower Receiver and Butt stock Assembly (5)**—Provides firing control for the weapon. Provides storage for M16A4 basic cleaning materials and adjustable butt stock for M4/M4A1.

**Cartridge Magazine (6)**—Holds cartridges ready for feeding and provides a guide for positioning cartridges for stripping. Provides quick reload capabilities for sustained firing.

**Small Arms Sling (7)**—Provides the means for carrying the weapon.

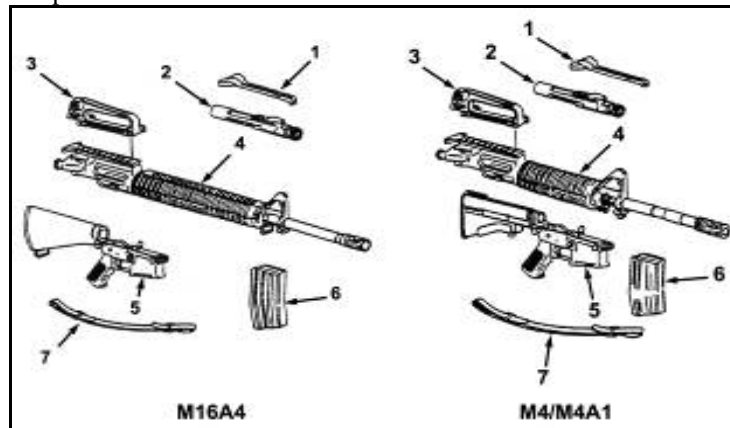

Figure 6-3. M16A4 and M4/M4A1 major assemblies

#### MAJOR ASSEMBLIES (RIGHT AND LEFT VIEWS)

The major assemblies for the M16- and M4-series weapons are described and numbered below (see figure 6-4).

**NOTE:** The following are Right View assemblies.

**Elevation Knob (1)**—Allows operator to adjust sights for range changes.

**Windage Knob (2)**—Allows operator to adjust to correct for effects of wind.

**Rear Sight Assembly (3)**—Contains short range (0-200m) and long range (300+m) apertures and adjustment controls.

**Brass Deflector (4)**—Prevents ejected cartridge case from striking operator.

**Front Sight Assembly (5)**—Contains adjustment front sight post.

**Bayonet Lug (6)**—Allows operator to attach bayonet to weapon.

**Ejection Port Cover (7)**—Closes over ejection port to prevent sand, dust, and other debris from entering chamber. Should remain closed when not firing the weapon.

**Cartridge Magazine (8)**—Contains up to 30 rounds of 5.56 mm ammunition.

**Magazine Catch (9)**—Holds magazine in place in magazine well and allows operator to release magazine and remove it from weapon.

**Trigger (10)**—When activated by operator, initiates firing sequence.

**Forward Assist Assembly (11)**—Ensures that the bolt is fully closed and locked.

**Charging Handle (12)**—Allows the operator to chamber a round and cock the weapon.

**NOTE:** The following are Left View assemblies.

**Compensator (13)**—Prevents the muzzle of the weapon from rising during firing.

**Carrying Handle (14)**—Allows the operator to carry the weapon.

**Front Sight Post (15)**—Allows operator to adjust strike of bullet up and down.

**Bolt Catch (16)**—Holds the bolt assembly to rear when last round is fired.

**Butt stock Assembly (17)**—Houses the action spring, buffer assembly, and extension assembly.

**Sling Swivel (18)**—Allows operator to attach sling to the weapon.

**Selector Lever (19)**—Allows the operator to select the mode of fire and place weapon on safe.

**Slip Ring (20)**—Holds the hand guards in place on the weapon.

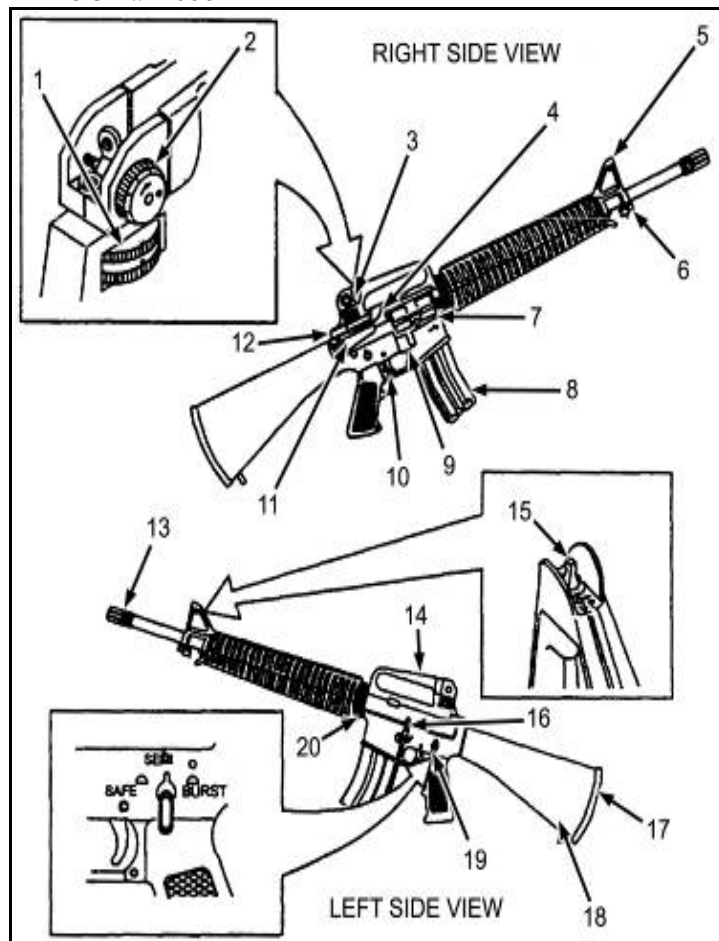

Figure 6-4. Major assemblies for the M16- and M4-series weapons (right and left views)

**DESCRIPTION (general accessories).**

The following are descriptions of various general accessories that can be attached to the M16- and/or M4-series weapons (see figure 6-5).

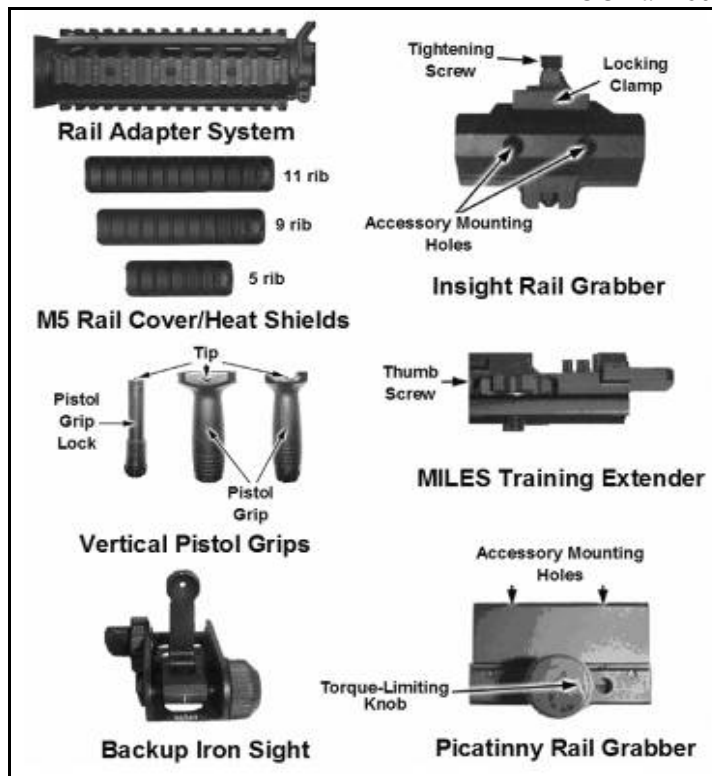

Figure 6-5. M16 and M4 series weapon system general accessories

**M4 Rail Adapter System:** The M4 rail adapter system (RAS) consists of a set of lightweight sections that replace the standard hand guards on the M4 carbine. The M5 RAS is standard issue on the M16A4. The RAS provides a secure mounting point for various accessories that may be mounted top, left, and right. The user may only remove the lower assembly to perform preventive maintenance checks and services. Accessories may be mounted on the right side of the RAS, but are not currently supported with 10- and 25-meter zeroing procedures. Only accessories that do not require retention such as a flashlight or vertical pistol grip can be mounted on the bottom rail.

**RAS Rail Covers/Heat Shields:** These protect the shooter's hands from direct contact with the metal parts of the RAS. They also protect the RAS surfaces from excess wear and damage, and can be quickly attached or detached from the RAS. The M5 RAS rail covers/heat shields are available in 11-, 9-, 6-, 5-, and 4-rib sections. Unused rail sections (full or partial) should stay covered with rail cover/heat shield sections. Each RAS also contains holes within the notches that are threaded 1/4-inch deep with 20 threads per inch—the standard thread size for a camera tripod adapter—which is used to attach standard camera or video accessories.

**Vertical Pistol Grip:** Each RAS comes with a vertical pistol grip.

**Insight and Picatinny Rail Grabbers:** The Insight rail grabber and the Picatinny rail grabber were designed to mount accessories onto the M16A4 and M4-series weapons. The Insight rail grabber is used to install the AN/PEQ-2A and AN/PAQ-4B/C. Each rail grabber has proven its ability to retain zero when installed and tightened properly. Both rail grabbers attach accessories on the upper receiver and on all four sides of the RAS. Once zeroed the rail grabbers can be removed from the weapon and will retain zero as long as they are not separated from the accessory and remounted on the exact same notch they were zeroed on. If the accessory and rail grabber is reinstalled on a different notch, or the rail grabber is separated from the accessory, they must be re-zeroed. A one-time retightening of the rail grabber and accessory is recommended after the first three rounds are fired to fully seat both.

**MILES Training Extender for the Insight Rail Grabber:** This extender is needed to elevate the accessory above the MILES laser during force-on-force training. Once the extender is installed, the accessory is installed on top of the extender and tightened. The training extender is only used when the Insight rail grabber is top mounted.

**Backup Iron Sight:** The backup iron sight (BIS) is a semi-permanent flip up iron sight, equipped with a rail-grabbing base. It is intended to remain on the MWS while the M68 close combat optic (CCO) reflex sight is used as the primary means of day fire control. If the M68 fails, the pre-zeroed BIS can be flipped up and used to continue the mission. The BIS provides a backup capability effective out to at least 600 meters and can be installed on the M16A4 and M4-series weapons. It also provides a sighting capability when all other accessories have been removed, and can be used to establish approximate zeros for other sighting components without requiring live fire. Figure 6-5 shows which weapons systems upon which this BIS can be mounted.

#### **DESCRIPTIONS (Optical Accessories)**

The following are descriptions of various optical accessories that can be attached to the M16- and/or M4-series weapons (see figure 6-6).

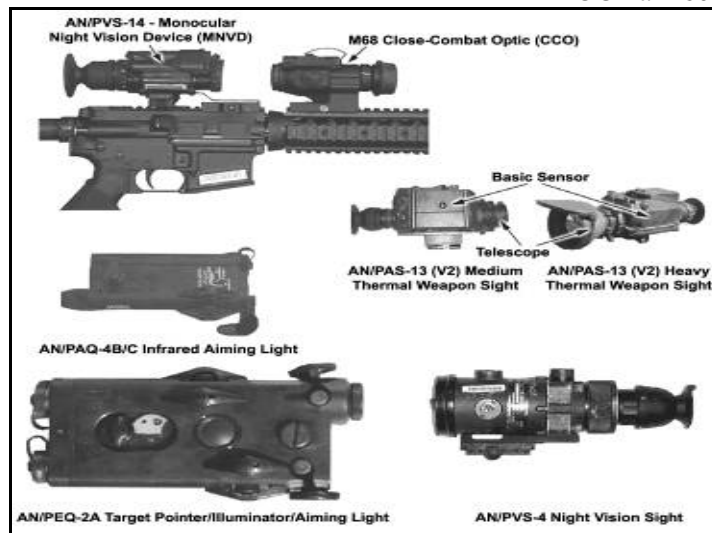

**Figure 6-6. M16 and M4-series weapon system optical accessories**

**M68 Close-Combat Optic (CCO):** This close-combat optic (CCO) is a reflex (non-telescopic) sight using a red dot aiming point and is designed for the “two-eyes-open” method of sighting. The M68 can be shot with one eye open as well. The dot follows the horizontal and vertical movement of the gunner’s eye while remaining fixed on the target. The M68 can be mounted to the M16- and M4-series weapons. Table 6-1 shows which weapons systems upon which this CCO can be mounted.

**AN/PVS-14 Monocular Night Vision Device (MNVD):** This lightweight night vision device can be used in observation and in command and control missions. It can be hand held, head mounted, helmet mounted, or attached to the rifle. A 3X magnifier can be used for longer-range observations, and can be used in overcast and starlight conditions. The eyecup should be exchanged with the eye guard to reduce the light signature from the display when not viewing. Table 6-1 shows which weapons systems upon which this MNVD can be mounted.

**AN/PAQ-4B/C Infrared Aiming Light:** This infrared aiming light projects an infrared laser beam that cannot be seen with the eye but can be seen with night vision devices. This aiming light works with the AN/PVS-7-series goggles and the AN/PVS-14. The AN/PAQ-4B/C mounts on various M16-/M4-series weapons with mounting brackets or rail grabbers. A remote activation switch can be installed as well. The C designator is for models where the light stays on constantly, whereas the B model has a light that pulses. Table 6-1 shows which weapons systems upon which this aiming light can be mounted.



**AN/PEQ-2A Target Pointer/Illuminator/Aiming Light:** This target pointer/illuminator/aiming light (TPIAL) emits a highly collimated beam of infrared light for precise aiming of the weapon as well as a separate infrared illumination beam with adjustable focus to illuminate shadowed areas. The AN/PEQ-2A can be used during force-on-force training in the low power modes only. High power modes can only be used on live-fire ranges exceeding 220 meters. The AN/PEQ-2A is used in conjunction with night vision devices and can be used as a handheld illuminator/pointer or can be weapon-mounted with included brackets/accessory mounts. The AN/PEQ-2A can be used to accurately direct fire as well as illuminate and designate areas and targets. Table 6-1 shows which weapons systems upon which this TPIAL can be mounted.

**AN/PAS-13 (V2) Medium and (V3) Heavy Thermal Weapon Sights (TWS):** These medium and heavy thermal weapon sight systems are silent, lightweight, compact, and durable battery-powered infrared imaging sensors that operate with low battery consumption. The Thermal Weapon Sights (TWSs) are capable of target acquisition under conditions of limited visibility such as darkness, smoke, fog, dust, and haze. The TWS operates effectively at night and during the daytime. The TWS is composed of a telescope and a basic sensor. Table 6-1 shows which weapons systems upon which these TWSs can be mounted.

**AN/PVS-4 Night Vision Sight:** This night vision sight is a portable, battery-operated electro-optical instrument used for observation and aimed fire of weapons at night. It amplifies reflected light, such as moonlight, starlight, and sky glow so that the viewed scene becomes clearly visible to the operator. The AN/PVS-4 does not emit visible or infrared light (except from the eyepiece) that can be detected by the enemy. AN/PVS-4 is primarily designed for use with the M14 and M16 rifles, M249 squad automatic weapon, M72A1 rocket launcher, and M203 grenade launcher. Table 6-1 shows which weapons systems upon which this night vision sight can be mounted.

**Table 6-1**  
**Accessory weapon system matrix**

INTEGRATION MATRIX - INDIVIDUAL WEAPONS						INTEGRATION MATRIX - CREW SERVED WEAPONS				
Accessory	M16A2	M16/ M203	M4A1	M4/ M203	M24	Accessory	M249	M240	M2	MK19
AN/PAQ-4B/C	✓	✓	✓	✓		AN/PAQ-4B/C	✓	✓		
AN/PAS-13, TWS	✓					AN/PAS-13, TWS	✓	✓	✓	✓
AN/PEQ-2A	✓					AN/PEQ-2A	✓	✓	✓	✓
AN/PVS-4(A)	✓	✓	✓	✓		AN/PVS-4(A)	✓	✓		
AN/PVS-10, SNS					✓	AN/PVS-10, SNS				
AN/PVS-14						AN/PVS-14				
AN/TVS-5	✓					AN/TVS-5			✓	✓
M68, CCO	✓		✓			M68, CCO				
M145, MGO						M145, MGO	✓	✓		
BIS			✓	✓		BIS				
MILES	✓	✓	✓	✓	✓	MILES	✓	✓	✓	✓
AN/PSX-1	✓	✓	✓	✓	✓	AN/PSX-1	✓	✓	✓	✓
Notes: When mounting the AN/PAQ-4B/C to the M203 the grenadier must first have the Quadrant Sight Removed. CCO - Close Combat Optic MGO - Machine Gun Optic BIS - Back-up Iron Sight						1. Final configuration for the M240B will be w/the AN/PEQ-2A. The AN/PAQ-4B/C may be used if the AN/PEQ-2A is unavailable. 2. The MGO will used on the M249 only when it is employed in the light machine gun role. 3. The AN/PSX-1 will replace the AN/PAQ-4B/C once fielded.				

**TECHNICAL DATA:** Table 6-2 contains the general characteristics of each weapon system. Table 6-3 shows the characteristics of the various optical accessories.

**Table 6-2**  
**Characteristics of the M16-/M4-series weapons**

CHARACTERISTIC	M16A1	M16A2/A3	M16A4	M4
<b>WEIGHT (pounds):</b>				
Without magazine and sling	6.35	7.78	9.08	6.49
With sling and loaded				
20-round magazine	6.75	8.48	9.78	7.19
30-round magazine	7.06	8.79	10.09	7.50
Bayonet knife, M9	1.50	1.50	1.50	1.50
Scabbard	0.30	0.30	0.30	0.30
Sling M1	0.40	0.40	0.40	0.40
<b>LENGTH (inches):</b>				
Rifle w/bayonet knife	44.25	44.88	44.88	N/A
Overall rifle length	30.00	39.63	39.63	N/A
Buttstock closed	N/A	N/A	N/A	29.75
Buttstock open	N/A	N/A	N/A	33.0
<b>OPERATIONAL CHARACTERISTICS:</b>				
Barrel rifling-right hand 1 twist (inches)	12	7	7	7
Muzzle velocity (feet per second)	3,250	3,100	3,100	2,970
Cycle rate of fire (rounds per minute)	700-800	700-900	800	700-900
<b>MAXIMUM EFFECTIVE RATE OF FIRE:</b>				
Semiautomatic (rounds per minute)	45-65	45	45	45
Burst (3-round bursts) (rounds per minute)	N/A	90	90	90
Automatic (rounds per minute)	150-200	150-200 A3	N/A	N/A
Sustained (rounds per minute)	12-15	12-15	12-15	12-15
<b>RANGE (meters):</b>				
Maximum range	2,653	3,600	3,600	3,600
Maximum effective range				
Point target	460	550	550	500
Area target	N/A	600	600	600

**Table 6-3**

**Characteristics of various accessories for the M16-/M4-series weapons**

CHARACTERISTICS	ACCESSORY				
	CCO	PAQ-4C	PEQ-2A	MTWS	HTWS
WEIGHT	6.2 oz	5.75 oz	7.5 oz	4.1bs	4.5bs
LENGTH	4.9 in	5.5 in	6.4 in	15.5 in	18 in
HEIGHT	2.5 in	1.2 in	1.2 in	6.25 in	6.25 in
RANGE	300m	*600m	*600m	*1,600m	*2,200m
MOUNTING DEVICE: M16A1/A2/A3 M4 carbine M16A4 and M4 MWS	M16 mount **Upper receiver **Upper receiver	Bracket Assy Bracket Assy ***Rail grabber	Bracket Assy Bracket Assy ***Rail grabber	M16 mount Upper receiver Upper receiver	M16 mount Upper receiver Upper receiver
WINDAGE (1 increment clockwise) Top side mounted Left side mounted	Left 4 mm N/A	Left 1 cm Left 1 cm	Right 1 cm Left 1 cm	Wide / Narrow 1 1/4 cm / 3/4 cm N/A	Wide / Narrow 3/4 cm / 3/4 cm N/A
ELEVATION (1 increment clockwise) Top side mounted Left side mounted	Down 4 mm N/A	Up 1 cm Down 1 cm	Up 1 cm Up 1 cm	1 1/4 cm / 3/4 cm N/A	3/4 cm / 3/4 cm N/A

\* Actual range is dependent upon ambient light, NVGs, and background contrast.  
 \*\* With half-moon spacer installed.  
 \*\*\* Picatinny or insight rail grabbers may be used.

**AMMUNITION:** Use only approved ammunition (see figure 6-7). Do not fire seriously corroded ammunition, dented cartridges, cartridges with loose bullets, cartridges exposed to extreme heat (135°) until they have cooled, or cartridges with the bullet pushed in (short rounds). Turn all found ammunition to the Range NCO. Use only authorized ammunition. Keep ammunition dry and clean.

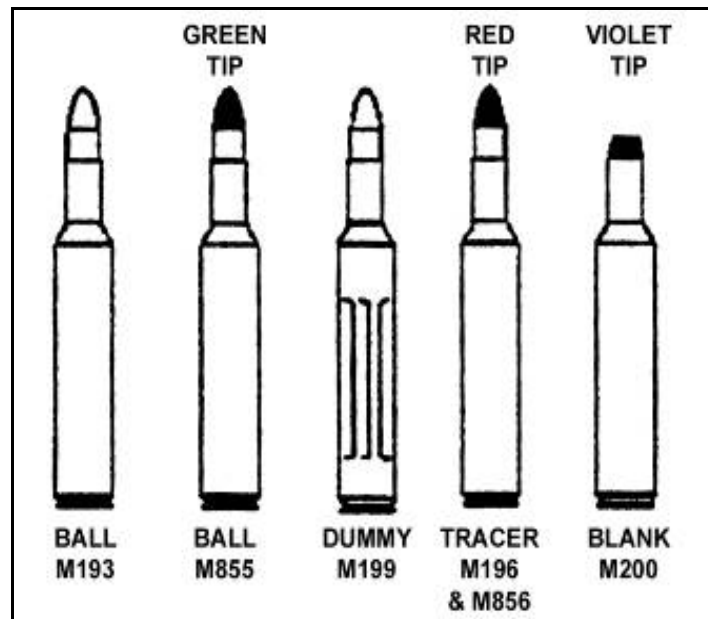

**Figure 6-7. Approved ammunition**

## 6-2. M203 grenade launcher

**DESCRIPTION:** The M203 grenade launcher is a lightweight, single-shot, breech-loaded, pump action (sliding barrel), shoulder-fired weapon that is attached to an M16 rifle series, or the M4 carbine series with the M203A1 (see figure 6-8), and M4 carbine series with the rail system (see figure 6-9).



Figure 6-8. M4 carbine with M203A1 (left side view)



Figure 6-9. M4 carbine with rail system

**MAJOR ASSEMBLIES:** Figure 6-10 shows the M203's major assemblies, and the following paragraphs describe their purposes.

**Handguard:** The handguard assembly houses the rifle barrel.

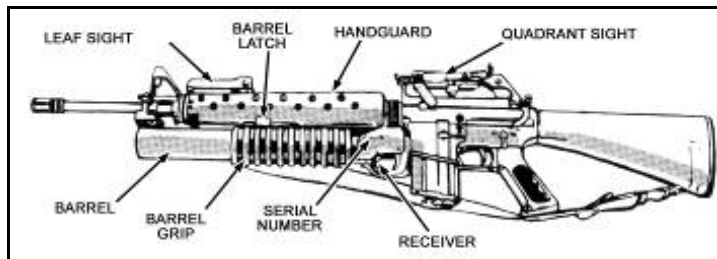

Figure 6-10. Major assemblies of the M203 grenade launcher

**Quadrant Sight Assembly:** The quadrant sight assembly, which attaches to the left side of the rifle's carrying handle, enables the grenadier to adjust for elevation and windage. This assembly consists of the sight, mounting screw, sight latch, rear sight aperture, sight aperture arm, front sight post, and sight post arm.

TRADOC Pam 600-4

**Receiver Assembly and Serial Number:** The receiver assembly houses the firing mechanism and ejection system and supports the barrel assembly. On the left side of the receiver, assembly is the launcher's serial number.

**Barrel Assembly:** The barrel assembly holds the cartridges ready for firing and directs the projectile.

**Barrel Latch:** On the left side of the barrel is a latch that locks the barrel and receiver together. To open the barrel, depress the barrel latch and slide the barrel forward.

**Leaf Sight Assembly:** The leaf sight assembly is attached to the top of the handguard. The leaf sight assembly consists of the sight, its base and mount, an elevation adjustment screw, and a windage adjustment screw. Elevation and windage scales are marked on the mount. The folding, adjustable, open ladder design of the sight permits rapid firing without sight manipulation. The front sight post of the M16-series rifle serves as the front aiming post for the M203 leaf sight.

**Trigger Guard:** The trigger guard protects the trigger. Depressing the rear portion of the trigger guard rotates it down and away from the magazine well of the rifle, which allows the weapon to be fired while the firer is wearing gloves or mittens.

**Safety:** The safety is inside the trigger guard, just in front of the trigger. For the launcher to fire, the safety must be forward. When the safety is rearward, the launcher is on SAFE. The safety is manually adjusted.

#### **TECHNICAL DATA**

Table 6-4 contains M203/M203A1 grenade launcher technical data.

**Table 6-4**  
**M203/M203A1 grenade launcher technical data**

<b>M203/M203A1 Grenade Launcher Technical Data</b>	
<b>Weapon</b>	
<b>Length</b>	
Rifle and Grenade Launcher (overall)	99.0 cm (39 inches)
Barrel Only	30.5 cm (12 inches)
Rifling	25.4 cm (10 inches)
<b>Weight</b>	
Launcher Unloaded	1.4 kg (3.0 pounds)
Launcher Loaded	1.6 kg (3.5 pounds)
Rifle and Grenade Launcher, Both Fully Loaded	5.0 kg (11.0 pounds)
Number of Lands	6 right hand twist
<b>Ammunition</b>	
Caliber	40 mm
Weight	About 227 grams (8 ounces)
<b>Operational Characteristics</b>	
Action	Single shot
Sights	Front leaf sight assembly Rear quadrant sight
Chamber Pressure	206,325 kilopascals (35,000 psi)
Muzzle Velocity	76 mps (250 fps)
Maximum Range	About 400 m (1,312 ft)
Maximum Effective Range	Fire-team sized area target - 350 m (1,148 ft)
	Vehicle or weapon point target - 150 m (492 ft)
<b>Minimum Safe Firing Range (HE)</b>	
Training	130 meters (426 feet)
Combat	31 meters (102 feet)
Minimum Arming Range	About 14 to 38 meters (46 to 125 feet)
Rate of Fire	5 to 7 rounds per minute
Minimum Combat Load	36 HE rounds

**AMMUNITION:** The M203 grenade launcher uses several fixed-type, low-velocity 40-mm rounds. The M203 fires high explosive, illuminating, signaling, CS, training, and multipurpose ammunition (see figure 6-11). The following paragraphs discuss only the most commonly used ammunition.

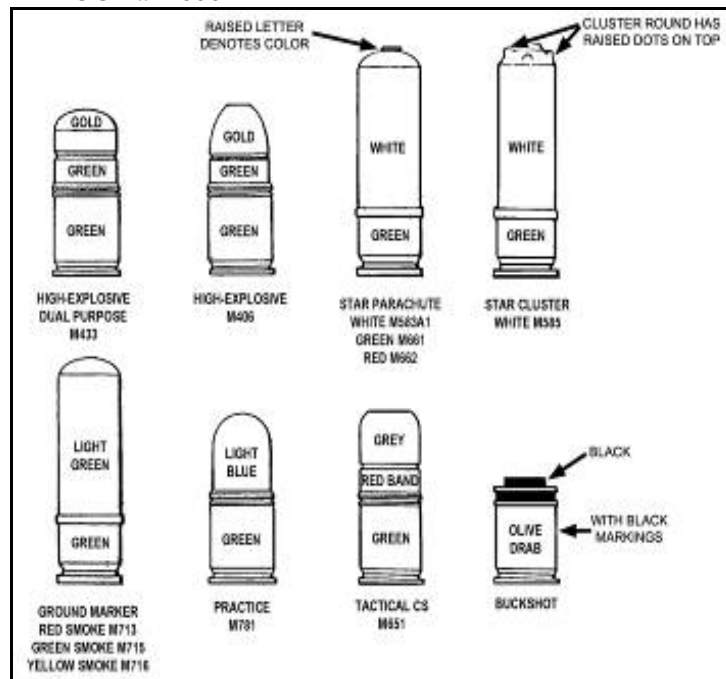

Figure 6-11. Cartridges for the M203 grenade launcher

**High-Explosive Dual Purpose Round:** The HEDP round has an olive drab aluminum skirt with a steel cup attached, white markings, and a gold ogive (head of the round). It penetrates at least 5 cm (2 inches) when fired straight at steel armor at 150 meters or less. It arms between 14 and 27 meters, causes casualties within a 130-meter radius, and has a kill radius of 5 meters when fired at a point target.

**High-Explosive Round:** The HE round has an olive drab aluminum skirt with a steel projectile attached, gold markings, and a yellow ogive. It arms between 14 and 27 meters, produces a ground burst that causes casualties within a 130-meter radius, and has a kill radius of 5 meters.

**Star Parachute Round:** This round is white impact or bar alloy aluminum with black markings. It is used for illumination, signals and is lighter and more accurate than comparable handheld signal rounds. The parachute attached to the round deploys upon ejection to lower the candle at 7 feet per second. The candle burns for about 40 seconds. A raised letter on the top of the round denotes the color of the parachute.

**White Star Cluster Round:** This round is white impact or bar aluminum alloy with black markings. The attached plastic ogive has five raised dots for night identification. The round is used for illumination or signals. It is lighter and more accurate than comparable handheld signal rounds. The individual stars burn for about 7 seconds during free fall.

**Ground Marker Round:** This round is light green impact aluminum with black markings. It is used for aerial identification and for marking the location of Soldiers on the ground. It arms between 15 and 45 meters. If a fuze fails to function on impact, the output mixture provided in the front end of the delay casing backs up the impact feature. The color of the ogive indicates the color of the smoke.

**Practice Round:** Used for practice, this round is blue zinc or aluminum with white markings. It produces a yellow or orange signature on impact, arms between 14 and 27 meters, and has a danger radius of 20 meters.

**CS Round:** This round is gray aluminum with a green casing and black markings. Though it is a multipurpose round, it is most effective for riot control and in MOUT. It arms between 10 and 30 meters and produces a white cloud of CS gas on impact.

**Buckshot Round:** This round is olive drab with black markings. Though it is a multipurpose round, it is most effective in thick vegetated areas or for room clearing. Inside are 2,000 pellets that cast a cone of fire 30 meters wide and 30 meters high at 269 meters per second. Be sure to aim buckshot rounds at the foot of the target. The round has no mechanical-type fuze.

### 6-3. M249 machine gun

**DESCRIPTION:** The M249 AR is a gas-operated, air-cooled, belt-and magazine-fed, automatic weapon that fires from the open-bolt position (see figure 6-12). It has a maximum rate of fire of 850 rounds per minute. Primarily, ammunition is fed into the weapon from a 200-round ammunition box containing a disintegrating metallic split-link belt. As an emergency means of feeding, the M249 AR can use a 20- or 30-round M16 rifle magazine, but this will increase the chance of stoppages. Although the M249 AR is primarily used as an automatic rifle, it is also used as a light machine gun. It can be fired from the shoulder, hip, or underarm position, or from the biped-steadied position. When employed as a machine gun, it has a tripod with a T&E mechanism and a spare barrel. However, barrels must not be interchanged with those from other M249s unless the headspace has been set for that weapon by direct support personnel.

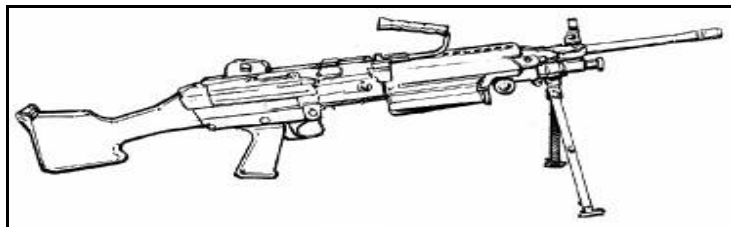

Figure 6-12. M249 automatic rifle



**MAJOR ASSEMBLIES:** The major assemblies of the M249 AR are numbered and shown in figure 6-13. Assembly details follow.

**Barrel assembly (1):** Houses cartridges for firing, directs projectile, and supports the gas regulator.

**Heat Shield Assembly (2):** Provides protection for the automatic rifleman's hand from a hot barrel.

**Rear Sight Assembly (3):** Adjusts for both windage and elevation.

**Cover and Feed Mechanism Assembly (4):** Feeds linked belt ammunition and positions and holds cartridges in position for stripping, feeding, and chambering.

**Feed Tray Assembly (5):** Positions belted ammunition for firing.

**Cocking Handle Assembly (6):** Pulls the moving parts rearward. Moves in a guide rail fixed to the right side of the receiver.

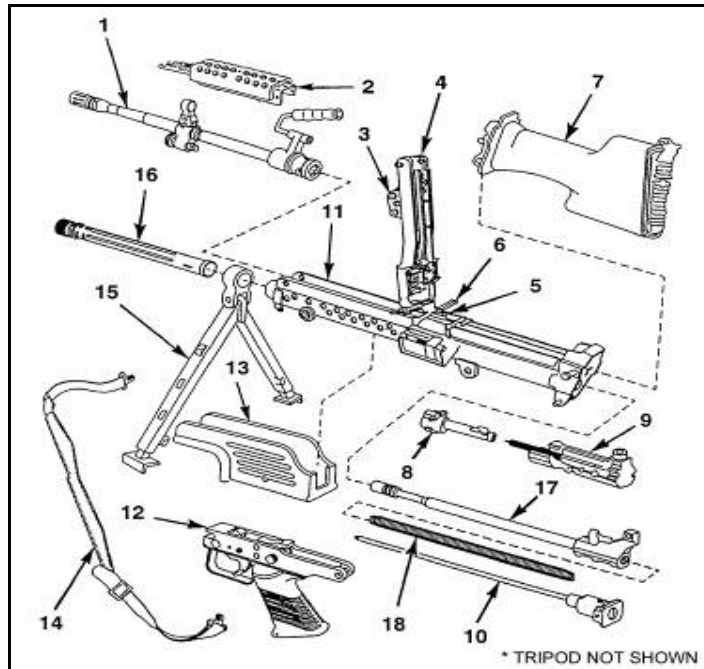

**Figure 6-13. M249 AR major assemblies**

**Butt stock and Buffer Assembly (7):** Contains a folding butt plate. Serves as a shoulder support for aiming and firing M249. Contains a buffer to absorb recoil.

**Bolt Assembly (8):** Provides feeding, stripping, chambering, firing, and extraction using the projectile gases for power.

**Slide Assembly (9):** Houses firing pin and roller assembly.

**Return Rod and Transfer Mechanism Assembly (10):** Absorbs recoil for bolt and operating rod assembly at the end of the recoil movement.

**Receiver Assembly (11):** Serves as a support for all major components and houses action of weapon. Through a series of camways, controls functioning of weapon.

**Trigger Mechanism (12):** Controls the firing of the weapon. Provides storage area for lubricant in grip portion.

**Handguard Assembly (13):** Provides thermal insulation to protect automatic rifleman's hands from heat or extreme cold and houses the cleaning equipment.

**Sling and Snap Hook Assembly (14):** Provides a means of carrying the weapon.

**Bipod (15):** Supports M249 AR in prone position. The telescopic legs can be individually adjusted to three different lengths.

**Gas Cylinder Assembly (16):** Locks bipod in place and provides passageway for operating gases.

**Piston Assembly (17):** Holds the bolt and slide assemblies and houses the return spring.

**Return Spring (18):** Returns the bolt, slide, and piston assemblies to locked position during counter-recoil cycle.

#### TECHNICAL DATA

Table 6-5 contains M249 automatic rifle technical data.

**Table 6-5**

**M249 AR technical data**

<b>M249 AR Technical Data</b>	
<b>Weapon</b>	
Tracer Burnout	900 meters (+)
Length of M249	40.87 inches
Weight of M249	
With Modification Kit	16.41 pounds
Without Modification Kit	15.30 pounds
<b>Ammunition</b>	
5.56-mm ball and tracer (mix) ammunition. Packaged in 200-round boxes, each weighing 6.92 pounds	
20-round magazines, each weighing .7 pounds	
30-round magazines, each weighing 1.07 pounds	
Other types of ammunition include tracer, blank, and dummy	

**Table 6-5**

**M249 AR technical data, continued**

<b>Operational Characteristics</b>	
Maximum Range	3,600 meters
Point Targets	600 meters
Area Targets	800 meters
Suppression	1,000 meters
<b>Rates of Fire</b>	
Sustained	85 rounds per minute (with no barrel changes)
Rapid	200 rounds per minute (with barrel change after 2 minutes)
Cyclic	850 rounds per minute (with barrel change after 1 minute)
Basic Load Ammunition	600 rounds carried by automatic rifleman in three 200-round boxes
Maximum Extent of Grazing Fire Obtainable Over Uniformly Sloping Terrain	600 meters

**AMMUNITION:** The M249 AR uses several different types of 5.56-mm standard military ammunition. Soldiers should use only authorized ammunition that is manufactured to U.S. and NATO specifications. Figure 6-14 shows the specific types of M249 AR ammunition and their characteristics.

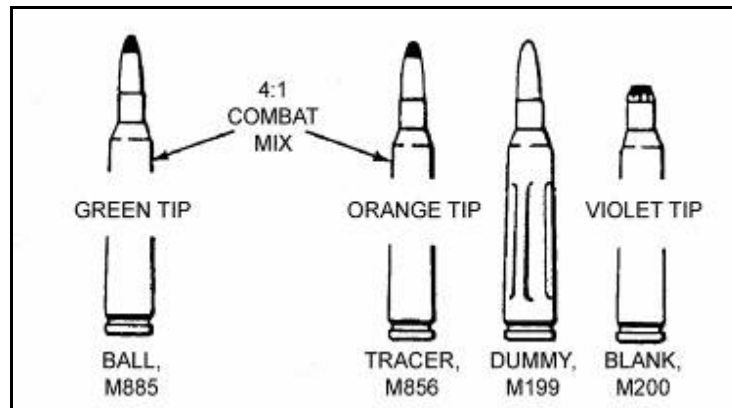

**Figure 6-14. Cartridges for the M249 AR**

**Cartridge, 5.56-mm ball M855 (A059):** The M855 cartridge has a gilding, metal-jacketed, lead alloy core bullet with a steel penetrator. The primer and case are waterproof. The ammunition is linked by a

disintegrating metallic split-linked belt for firing from the ammunition box. In an emergency, the M855 round can also be loaded and fired from the M16 20- or 30-round magazine. It is identified by a green tip, has a projectile weight of 62 grains, and is 2.3 cm long. This is the NATO standard round. It is effective against personnel and light materials, not vehicles.

**Cartridge, 5.56-mm tracer, M856 (A064):** This cartridge has a 63.7-grain bullet without a steel penetrator. It is identified by an orange tip. The tracer is used for adjustments after observation, incendiary effects, and signaling. When tracer rounds are fired, they are mixed with ball ammunition in a ratio of four ball rounds to one tracer round. The DODAC for ball and tracer mix is A064.

**Cartridge, 5.56-mm dummy M199 (A060):** This cartridge can be identified by the six grooves along the side of the case beginning about one-half inch from its head. It contains no propellant or primer. The primer well is open to prevent damage to the firing pin. The dummy round is used during mechanical training, dry-fire exercises, and function checks.

**NOTE:** The 5.56-mm NATO cartridge may be identified by its appearance, the painting of projectile tips, the stamping of the manufacturer's initials and year of manufacture on the base of the cartridge case, and the markings on the packing containers. When removed from the original packing container, the cartridge may be identified by its physical characteristics. The M193 and M196 cartridge for the M16 can be fired with the M249, but accuracy is degraded. Therefore, it should only be used in emergency situations when M855 or M856 ammunition is not available.

**Cartridge, 5.56-mm blank M200 (M2 link, A075):** The blank cartridge has no projectile. The case mouth is closed with a seven-petal rosette crimp and has a violet tip. The original M200 blank cartridge had a white tip. Field use of this cartridge resulted in residue buildup, which caused malfunctions. Only the violet-tipped M200 cartridge should be used. The blank round is used during training when simulated live-fire is desired. An M15A2 blank-firing attachment must be used to fire this ammunition.

#### 6-4. M136 AT-4 antitank weapon

**INTRODUCTION:** The Tactical Weapon M136 (AT4) is a short range, man-portable, shoulder-fired weapon, consisting of a fiberglass reinforced launch tube fitted with a firing mechanism, pop-up sights, protective covers, carrying sling, three safety devices, shoulder stop and bumpers. The weapon is a recoilless rifle design. The Cartridge: 84MM is packaged and sealed in its disposable launcher and is issued as a round of ammunition. The projectile is a free flight, fin stabilized shell with a shaped charge high explosive anti-tank (HEAT) warhead.

TRADOC Pam 600-4

**DESCRIPTION:** The AT4 is a fully self-contained, lightweight, man-portable, right shoulder fired anti-armor weapon. The weapon consists of a free flight, fin-stabilized projectile, which is packaged and sealed in an expendable launcher that also serves as a transport and watertight storage container.

The AT4 is issued as a round of ammunition.

The barrel, which is provided, with a venturi to the rear, houses the cartridge case assembly and a fin-stabilized HEAT shell incorporating a shaped charge warhead.

Firing is mechanical. The rearward-moving firing rod strikes a pin and ignites the percussion cap.

### MAJOR ASSEMBLIES

Figure 6-15 shows the location of major M136 AT-4 assemblies.

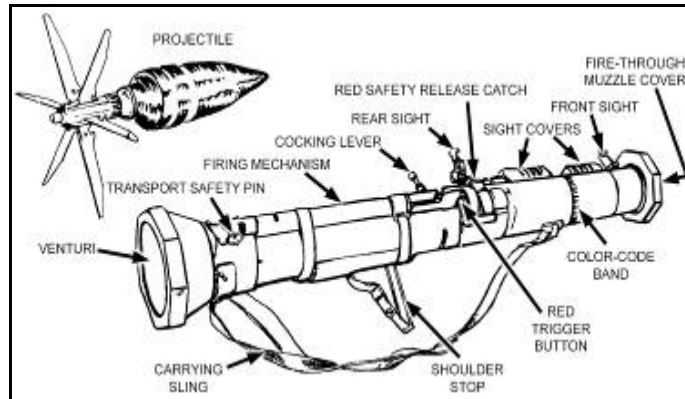

**Figure 6-15. M136 AT-4 antitank weapon major assemblies**

**Carrying Sling**—facilitates easy carrying of the weapon.

**Shoulder Stop**—folding metal and plastic bracket shoulder stop is designed to rest on the gunner's shoulder to support the AT4 while aiming and firing. When not in use, it is snapped to the under side of the launcher.

**Fire Control Mechanism**—Consists of a firing rod with firing rod spring, three safety devices (transport safety pin, cocking lever, and red safety release catch) and red trigger button. The weapon cannot be fired unless all three safeties have been disengaged.

**Transport Safety Pin**—Blocks the movement of the firing rod and prevents it from striking the percussion cap. To disengage: pull out.

**Cocking Lever**—Attached to the firing rod. When the lever is in the SAFE position, there is no engagement between the firing rod and the trigger. To cock: push lever forward and down. When the weapon is

cocked, the firing rod is engaged with the trigger through the hooks on the front part of firing rod and trigger.

**Red Safety Release Catch**—Located in forward end of firing mechanism. The red safety release catch consists of a steel rod that prevents the firing rod from striking the firing pin. To disengage press handle with fingertips of right hand.

**Red Trigger Button**—Located on the right side of the tube. To fire, apply pressure straight forward with right thumb in a steady, smooth movement.

**Front Sight**—Used in conjunction with the rear sight assembly for target engagement. The front sight consists of a sight blade, center post, and two lead posts. It is provided with a semicircular white line to aid in obtaining the proper sight picture.

**Rear Sight**—A 2-mil peephole rear sight is drilled in a leaf that covers the 7-mm peephole. To uncover the 7-mm peephole, lift cover leaf and push it to either side.

**Nightsight**—The AT4 can be fitted with the AN/PAQ-4C, AN/PEQ-2, or the AN/PAS-13, when used with the nightsight mounting bracket.

**Tactical Launcher**—A one-shot throwaway tube that houses the HEAT projectile. The launcher consists of:

- Barrel with venturi and fire-through muzzle cover.
- Firing mechanism.
- Shoulder stop.
- Carrying sling.
- Projectile.
- Mechanical sights protected by sliding covers.

**NOTE:** After firing cartridge, case remains in launcher tube.

**TECHNICAL DATA:** Table 6-6 contains M136 AT-4 technical data.

**Table 6-6****M136 AT-4 technical data**

<b>M136 AT-4 Technical Data</b>	
<b>Launcher</b>	
Length	1,020 mm (40 inches)
Weight (Complete System)	6.7 kg (14.8 pounds)
Rear Sight Range Indicator	Graduated in 50-meter increments
<b>Rocket</b>	
Caliber	84 mm
Muzzle Velocity	290 mps (950 fps)
Length	460 mm (18 inches)
Weight	1.8 kg (4 pounds)
<b>Minimum Range</b>	
Training	30 meters (100 feet)
Combat	10 meters (33 feet)
Arming	10 meters (33 feet)
<b>Maximum Range</b>	
2,100 meters (6,890 feet)	
<b>Maximum Effective Range</b>	
300 meters (985 feet)	
<b>Operating Temperature Range</b>	
-40°C to 60°C (-40° F to 140°F)	
<b>Front Sight Type</b>	
3-prong post	
<b>Rear Sight Type</b>	
Adjustable (with 2 and 7-mm peephole)	
<b>HEAT Warhead</b>	
Color code Black band identifies heat HEAT warhead	

**AMMUNITION:** The M136 AT4's warhead has excellent penetration ability and lethal after-armor effects. The extremely destructive, 440-gram shaped-charge explosive penetrates more than 14 inches (35.6 cm) of armor. Warhead effects are shown in figure 6-16. During the impact phase, the nose cone crushes and the impact sensor activates the fuze. During the ignition phase, the piezoelectric fuze element activates the electric detonator, and the booster detonates, initiating the main charge. During the penetration phase, the main charge fires and forces the warhead body liner into a directional gas jet that penetrates armor plate. During the after-armor effects (spalling) phase, projectile fragments and incendiary effects produce blinding light and destroy the interior of the target.

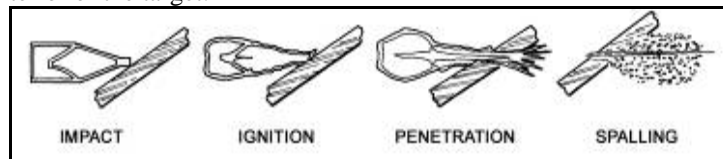
**Figure 6-16. Effects of M136 AT4 warhead**

## 6-5. Hand grenades

**DESCRIPTION:** The hand grenade is a handheld, hand-armed, and hand-thrown weapon. U.S. forces use colored smoke, white smoke, riot-control, special purpose, offensive, and practice hand grenades. Each grenade has a different capability that provides the Soldier with a variety of options to successfully complete any given mission.

Hand grenades give the Soldier the ability to kill enemy Soldiers and destroy enemy equipment. Historically, the most important hand grenade has been the fragmentation grenade, which is the Soldier's personal indirect weapon system. Offensive grenades are much less lethal than fragmentation grenades on an enemy in the open, but they are very effective against an enemy within a confined space.

Smoke and special purpose grenades can be used to signal (ground-to-ground or ground-to-air signaling devices, or as landing zone marking devices), to screen (as screening devices for unit movements), to control crowds or riots, to start fires, or to destroy equipment. The hand grenade is thrown by hand. Therefore, the range is short and the casualty radius is small. The 4 to 5-second delay on the fuze allows the Soldier to safely employ the grenade.

**COMPONENTS:** The hand grenade is made up of the following components (see figure 6-19). The figure also describes the functioning of the fuze.

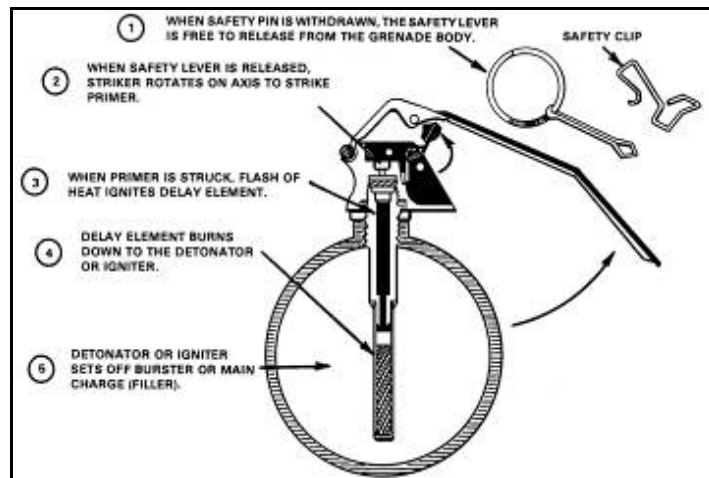

**Figure 6-17. Hand grenade components and fuze functioning**

**Body:** The body contains filler and, in certain grenades, fragmentation.

**Filler:** The filler is composed of a chemical or explosive substance that determines the type of hand grenade for employment factors.



**Fuze Assembly:** The fuze causes the grenade to ignite or explode by detonating the filler.

**Safety Pin:** The split end of the safety pin has an angular spread or diamond crimp.

**Safety Clip:** The safety clip (spring steel wire) consists of a loop, which fits around the fuze body and a clamp, which fits over the safety lever. It is designed to keep the lever in place should the safety pin be unintentionally removed from the grenade.

**FUZES:** The two types of fuzes used in current U.S. hand grenades are detonating and ignition. Both function in the same manner; the difference is how they activate the filler substance.

**Detonating Fuze:** Detonating fuzes explode within the grenade body to initiate the main explosion of the filler substance. Detonating fuzes include the M213 and M228 (see figure 6-20).

**Igniting Fuze:** Igniting fuzes are designed for use with chemical hand grenades. They burn at high temperatures and ignite the chemical filler. The M201A1 is designed for use with the AN-M83HC white smoke grenade, the AN-M14 TH3 incendiary grenade, and the M18 colored smoke grenade. This fuze is interchangeable with any standard firing device. The time delay element is a powder train requiring 1.2 to 2 seconds to burn to the igniter. The igniter ignites the filler or a pyrotechnic starter with a violent burning action and expels the filler from the grenade body (see figure 6-20).

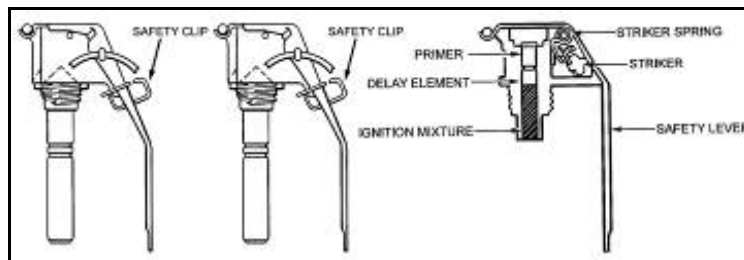

**Figure 6-18. M213, M228, and M201A1 Fuzes (left to right)**

**HAND GRENADE TYPES:** Cross-sectional views and descriptions of the commonly used hand grenades (see figures 6-19 through 6-26 and tables 6-7 through 6-14).

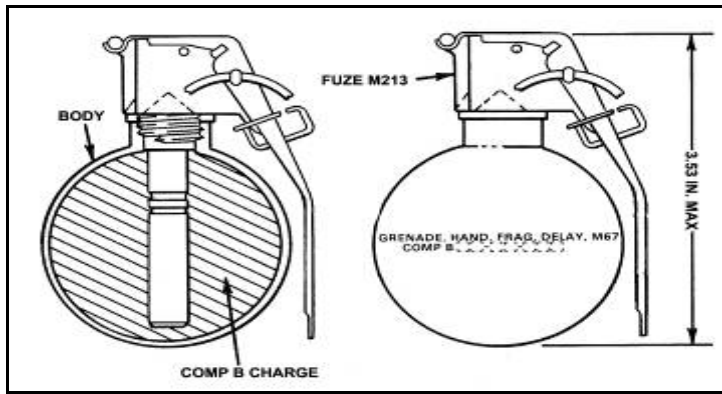

Figure 6-19. M67 Fragmentation hand grenade

Table 6-7

M67 Fragmentation hand grenade

	M67 Fragmentation Hand Grenade
<b>Body</b>	Steel sphere
<b>Filler</b>	6.5 ounces of Composition B
<b>Fuze</b>	M213
<b>Weight</b>	14 ounces
<b>Safety Clip</b>	Yes
<b>Capabilities</b>	The average Soldier can throw this grenade 35 meters. It has an effective killing radius of 5 meters, an effective casualty-producing radius of 15 meters, and fragmentation dispersal as far as 230 meters.
<b>Color and Markings</b>	Olive drab body with a single-yellow band at the top. Markings are in yellow.

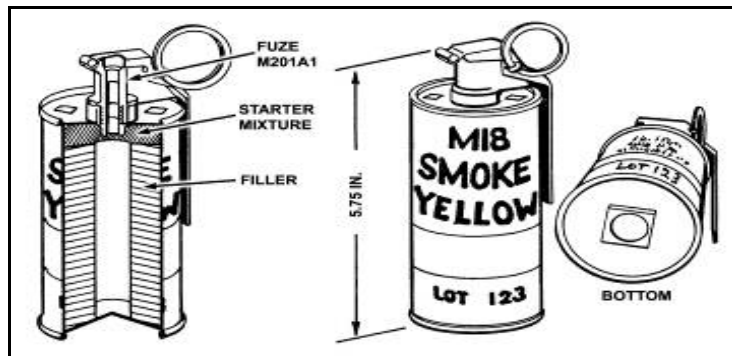
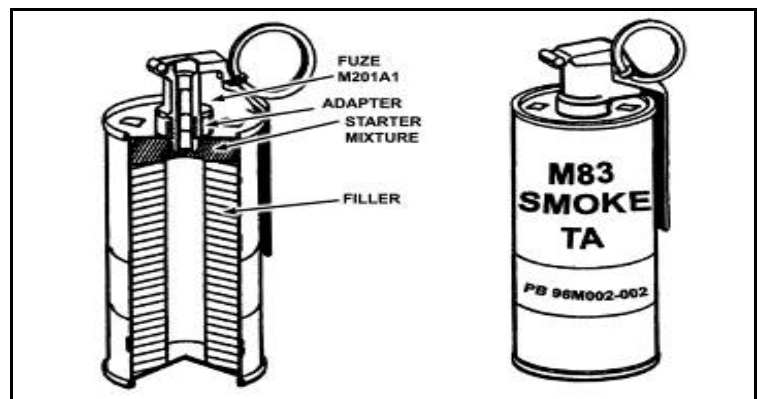

Figure 6-20. M18 Colored smoke hand grenade

**Table 6-8**

**M18 Colored smoke hand grenade**

<b>M18 Colored Smoke Hand Grenade</b>	
<b>Body</b>	Sheet steel cylinder with four emission holes at the top and one at the bottom. The holes allow smoke to escape when the grenade is ignited.
<b>Filler</b>	11.5 oz colored smoke mixture (red, yellow, green, and violet).
<b>Fuze</b>	M201A1
<b>Weight</b>	19 ounces
<b>Safety Clip</b>	None
<b>Capabilities</b>	The average Soldier can throw this grenade 35 meters. Produces colored smoke for 50 to 90 seconds.
<b>Color and Markings</b>	Olive drab body with the top indicating the smoke color.
<b>Field Expedient</b>	In combat, you may need to use the M18 hand grenade without the fuze. Use the following procedures in <u>combat only</u> : remove the tape from the grenade bottom to expose the filler, remove the fuze by unscrewing it from the grenade, ignite the starter mixture with an open flame, and throw the grenade immediately to avoid burn injury.



**Figure 6-21. AN-M83 HC White smoke hand grenade**

**Table 6-9**  
**AN-M83 HC white smoke hand grenade**

<b>AN-M83 HC White Smoke Hand Grenade</b>	
<b>Body</b>	Thin sheet metal cylinder (2.5 in dia, 5.7 in long).
<b>Filler</b>	11 ounces of terephthalic acid.
<b>Fuze</b>	M201A1
<b>Weight</b>	16 ounces
<b>Safety Clip</b>	None
<b>Capabilities</b>	Produces white smoke for 25-70 seconds.
<b>Color and Markings</b>	Forest green body with light green markings, a blue band, and a white top.

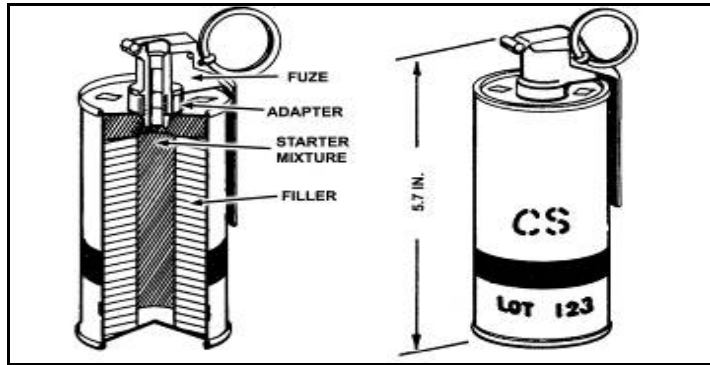
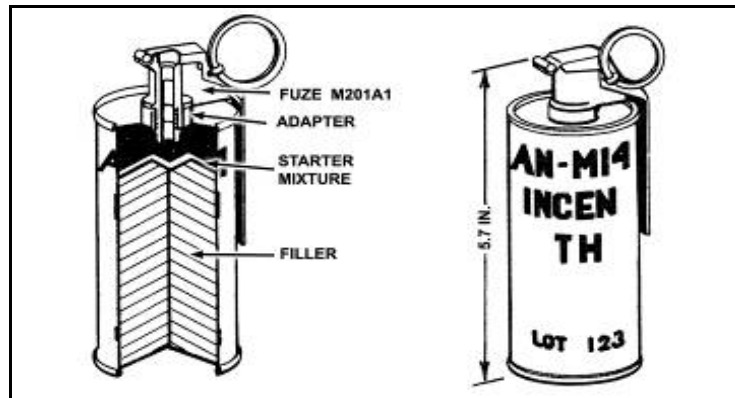

**Figure 6-22. ABC-M7A2 and ABC-M7A3 Riot-control hand grenades**

**Table 6-10**

**ABC-M7A2 and ABC-M7A3 Riot-control hand grenades**

	<b>ABC-M7A2 and ABC-M7A3 Riot-Control Hand Grenades</b>
<b>Body</b>	Sheet metal; 4 emission holes at the top and one at the bottom.
<b>Filler</b>	ABC-7A2 (5.5 oz burning mix and 3.5 oz CS in gelatin capsules); ABC-M7A3 (7.5 oz burning mix and 4.5 oz of pelletized CS agent).
<b>Fuze</b>	M201A1
<b>Weight</b>	15.5 ounces
<b>Safety Clip</b>	None
<b>Capabilities</b>	Average Soldier can throw it 40 meters. Both grenades produce a cloud of irritant agent for 15 to 35 seconds.
<b>Color and Markings</b>	Gray bodies with red bands and markings.



**Figure 6-23. AN-M14 TH3 Incendiary hand grenade**

**Table 6-11**  
**AN-M14 TH3 Incendiary hand grenade**

AN-M14 TH3 Incendiary Hand Grenade	
<b>Body</b>	Sheet metal
<b>Filler</b>	26.5 ounces of thermate (TH3) mixture
<b>Fuze</b>	M201A1
<b>Weight</b>	32 ounces
<b>Safety Clip</b>	None
<b>Capabilities</b>	Destroy equipment; start fires; damage, immobilize, or destroy vehicles, weapons systems, shelters, or munitions. Average Soldier can throw it 25 meters. A portion of the mix turns to molten iron (4,000* F) which fuzes together the metallic parts of any object it contacts; burns through a 1/2-inch homogenous steel plate. Burns under water.
<b>Color and Markings</b>	Gray with purple markings and a single purple band (current grenades). Under the standard color-coding system, incendiary grenades are light red with black markings.

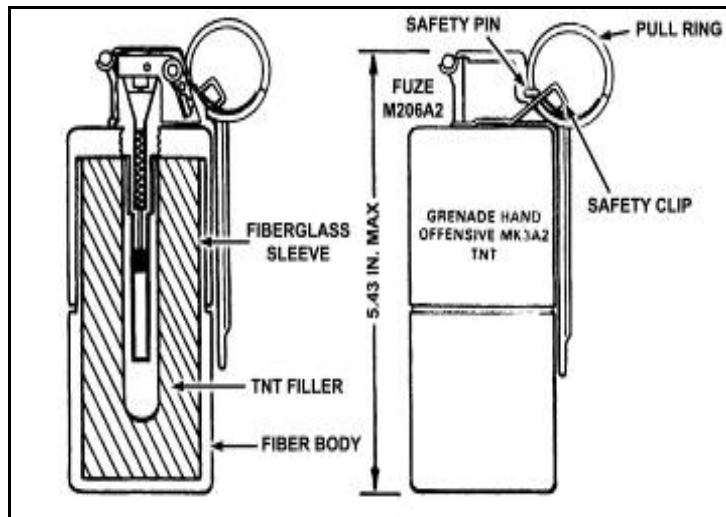
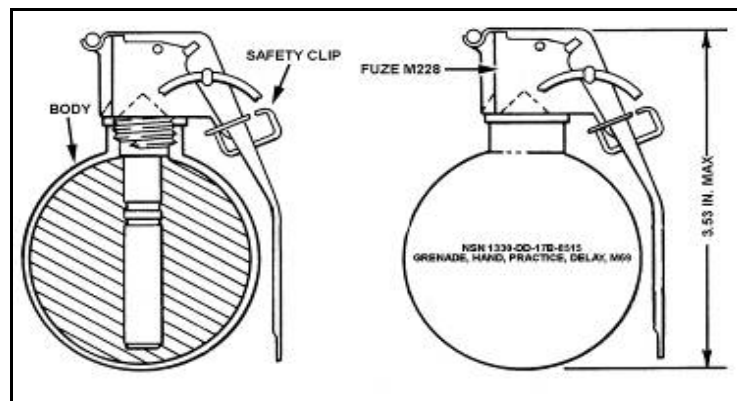

**Figure 6-24. MK3A2 Offensive (concussion) hand grenade**

**Table 6-12**

**MK3A2 offensive (concussion) hand grenade**

	<b>MK3A2 Offensive (Concussion) Hand Grenade</b>
<b>Body</b>	Fiber
<b>Filler</b>	8 ounces of TNT
<b>Fuze</b>	M206A1 or M206A2
<b>Weight</b>	15.6 ounces
<b>Safety Clip</b>	Issued with/without a safety clip.
<b>Capabilities</b>	Produce casualties during close combat; minimized fratricide; blasting/demolition tasks; enemy personnel located in bunkers, buildings, fortified areas. Average Soldier can throw it 40 meters; effective casualty radius of 2 meters in open areas, secondary effects to 200 meters from the detonation point.
<b>Color and Markings</b>	Black with yellow markings around the middle.



**Figure 6-25. M69 practice hand grenade**

**Table 6-13**  
**M69 practice hand grenade**

<b>M69 Practice Hand Grenade</b>	
<b>Body</b>	Steel sphere
<b>Filler</b>	
<b>Fuze</b>	M228
<b>Weight</b>	14 ounces
<b>Safety Clip</b>	Yes
<b>Capabilities</b>	Simulates M67 fragmentation grenades for realistic training; Average Soldier can throw it 40 meters. After a delay of 4 to 5 seconds, the M69 emits a small puff of white smoke and makes a loud popping noise. The grenade body can be used repeatedly by replacing the fuze assembly.
<b>Color and Markings</b>	Grenade: Light blue with white markings; Fuze: Light blue with black markings and a brown tip.

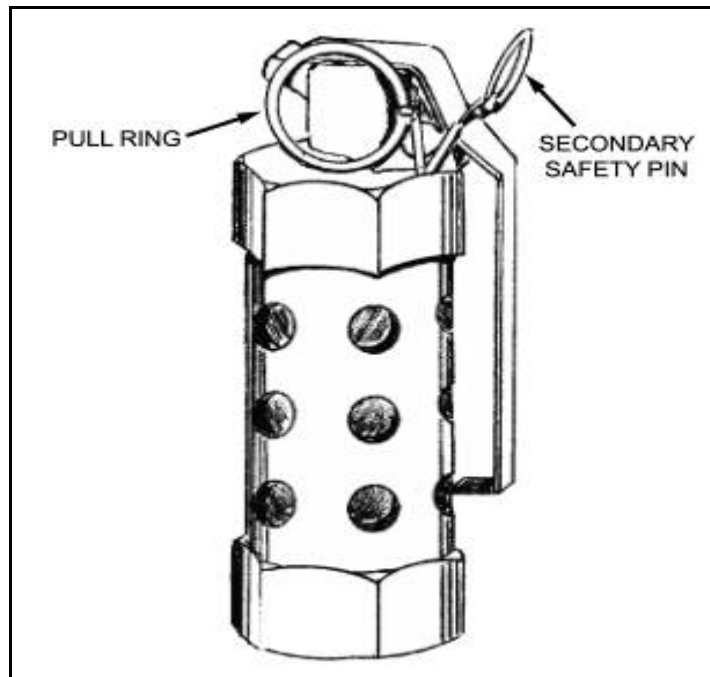

**Figure 6-26. M84 flash-bang stun hand grenade**



**Table 6-14****M84 flash-bang stun hand grenade**

	<b>M84 Flash-Bang Stun Hand Grenade</b>
<b>Body</b>	Steel hexagon tube; holes for emission of intense light/sound when ignited.
<b>Fuze</b>	M201A1
<b>Weight</b>	8.33 ounces
<b>Safety Clip</b>	Secondary safety pin w/ triangular pull ring.
<b>Capabilities</b>	Diversionsary for building/room clearing ops when noncombatants are likely/expected and assaulting element is attempting to achieve surprise; thrown into room/open door/window/opening; delivers loud bang/bright flash; temporary disorientation.
<b>Field Expedient</b>	Early warning device in <u>combat only</u> : grenade attached to secure object with tripwire extended across a path attached to modified grenade pull ring.

**6-6. M18A1 claymore mine****WARNING**

**This is meant to be a brief introduction to the M18A1 Antipersonnel Mine (Claymore). Never attempt to handle, maintain, emplace, connect, test, fire, or disarm a claymore mine using the narrative below. There are many safety procedures and instructions not covered here.**

**DESCRIPTION:** The number of ways in which the claymore mine may be employed is limited only by the imagination of the user. The Claymore is used primarily as a defensive weapon, but has its application in the offensive role. It must be emphasized that when the Claymore is referred to as a weapon, this implies that it is employed in the controlled role. In the uncontrolled role, the Claymore is considered a mine or booby trap.

**General:** The M18A1 antipersonnel mine was standardized in 1960, replacing the M18 antipersonnel mine. Both mines are similar in appearance and functioning. The M18A1 is a directional, fixed-fragmentation mine (see figure 6-27). When employed in the controlled role, it is treated as a one-shot weapon. It is primarily designed for use against massed infantry attacks. However, its fragments are also effective against light vehicles. The M18A1 mine is equipped with a fixer plastic slit-type sight, adjustable legs, and two detonator wells. The mine and all its accessories are carried in the M7 bandoleer (see figure 6-28). The instruction sheet for the M18A1 is sewn into the bandoleer. The Claymore mine weighs 3½ pounds, and

has the following dimensions (8½ inches long; 13/8 inches wide; 3¼ inches high (legs folded); 6 ¾ inches high [legs unfolded]).

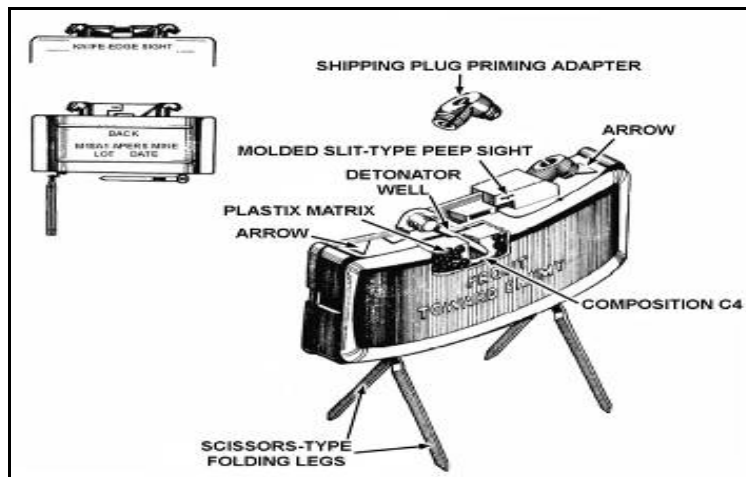

Figure 6-27. M18A1 antipersonnel mine (claymore) components

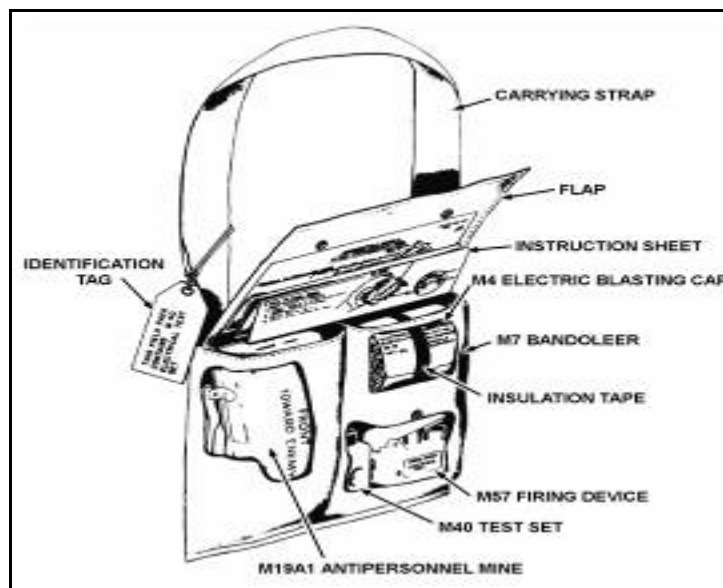
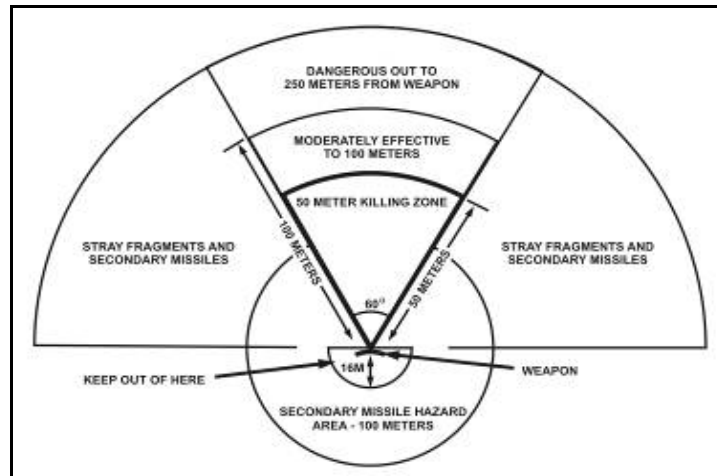

Figure 6-28. M18A1 antipersonnel mine and accessories packed in the M7 bandoleer

**Casualty Effects** (see figure 6-29): When detonated, the M18A1 mine will deliver spherical steel fragments over a 60° fan-shaped pattern that is 2 meters high and 50 meters wide at a range of 50 meters. These fragments are moderately effective up to a range of 100 meters and can travel up to 250 meters forward of the mine. The optimum effective

range (the range at which the most desirable balance is achieved between lethality and area coverage) is 50 meters.

**Danger Area** (see figure 6-29): The danger area consists of a 180° fan with a radius of 250 meters centered in the direction of aim. Within an area of 16 meters to the rear and sides of the mine, back blast can cause injury by concussion (ruptured eardrums) and create a secondary missile hazard. Friendly troops are prohibited to the rear and sides of the mine within a radius of 16 meters. The minimum safe operating distance from the mine is 16 meters. At this distance, and regardless of how the mine is employed, the operator should be in a foxhole, behind cover, or lying prone in a depression. The operator and all friendly troops within 100 meters of the mine must take cover to prevent being injured by flying secondary objects such as sticks, stones, and pebbles.



**Figure 6-29. Danger radius and effects of M18A1**

**MAJOR ASSEMBLIES:** The major assemblies of the M18A1 Claymore mine are described below (see figure 6-30).

**Firing unit (mine):** The firing unit's outer surface is a curved, rectangular, olive-drab, molded case of fiberglass-filled polystyrene (plastic). In the front portion of the case is a fragmentation face containing steel spheres embedded in a plastic matrix. The back portion of the case behind the matrix contains a layer of explosive.

**Explosive:** 1 ½ pounds of composition C4.

**Detonator wells and shipping plug priming adapter:** Two detonator wells are located on the top of the mine that allows for single or dual priming. These wells are sealed by the plug ends of the shipping plug priming-adapters that prevent entry of foreign materials into the detonator wells. The slotted end of the shipping plug priming-adapter is used to hold an electric blasting cap in place when the mine is armed.

The shipping plug priming-adaptor is merely reversed when the mine is to be armed.

**Peep sight and arrows:** The molded slit-type peep sight and arrows located on top of the mine are used to aim the mine.

**Legs:** Two pairs of scissors-type folding legs located on the bottom of the mine enable it to be emplaced on the ground. The mine can also be tied to posts, trees, etc.

**M57 firing device:** One M57 electrical firing device is issued with each M18A1. This device is a hand-held pulse generator. A squeeze of the handle produces a double (one positive, one negative) 3-volt electric pulse of sufficient energy to fire the electric blasting cap through the 100 feet of firing wire that is issued with the mine. The M57 device is 4 inches long, approximately 1½ inches wide, ¾ inches high, and weighs ¾ of a pound. On one end of the firing device is a rubber connecting plug with a dust cover. The safety bail on the M57 electrical firing device has two positions. In the upper SAFE position, it acts as a block between the firing handle and the pulse generator. In the lower FIRE position, it is clear of the firing handle and allows the pulse generator to be activated. The M57 electrical firing device and firing wire should not be discarded after initial use. Another electric blasting cap can be attached to the firing wire and the M57 device can be used to fire other devices, such as fougasse bombs and demolition charges, provided no more than 100 feet of firing wire and one M6 blasting cap are used.

**M4 electric blasting cap:** The M4 electric blasting cap consists of an M6 electric blasting cap attached to 100 feet of firing wire. Attached to the firing wire connection is a combination shorting plug and dust cover. The shorting plug prevents accidental functioning of the blasting cap by static electricity; the dust cover prevents dirt and moisture from entering the connector. The firing wire is wrapped around a flat paper and then rolled to form a package 6 inches long, 4 inches wide, and 2 inches high. A piece of insulating tape is used to hold the package together.

**M40 test set:** The M40 test set is an instrument used for checking the continuity of the initiating circuit of the mine.

**M7 Bandoleer:** The M7 bandoleer is constructed of water resistant canvas (olive-drab color) and has snap fasteners that secure the flap. The bandoleer has two pockets. One pocket contains the mine; the other contains a firing device, a test set, and an electric blasting cap assembly. A 2-inch wide web strap, which is used as a shoulder-carrying strap is sewn to the bag. An instruction sheet is sewn to the inside flap.

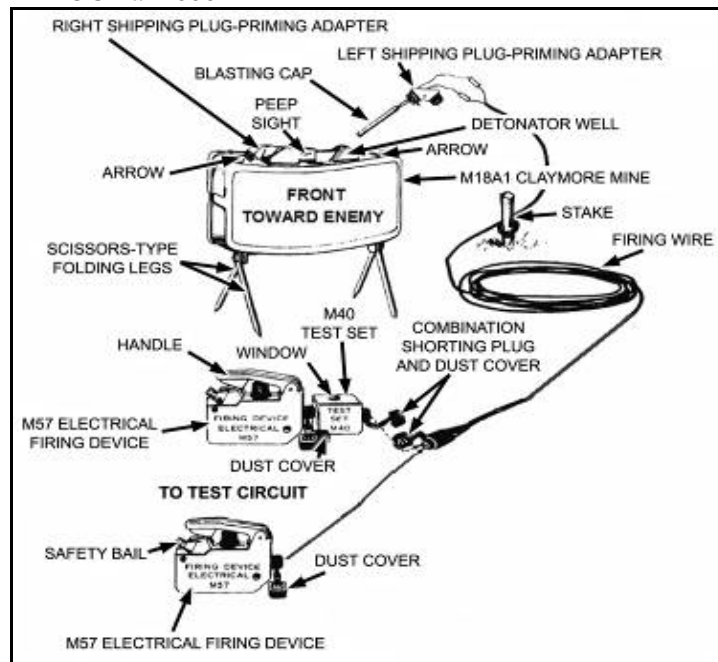

Figure 6-30. Arming and testing the M18A1 claymore mine

**FIRE DISCIPLINE:** Since the M18A1 mine can be fired only once, fire discipline is of paramount importance. The mine should not be used against single personnel targets; rather, it should be used for its intended purpose - massed personnel. When lead elements of an enemy formation approach within 20 to 30 meters of the mine, it should be detonated. If practicable, and to insure fire discipline, actual authority and responsibility for target selection and timely detonation should rest with squad leaders or their superiors.

**CONTROLLED FRONTAL COVERAGE:** For effective coverage of the entire front of a position, mines can be placed in a line no closer than 5 meters and no farther apart than 45 meters. Preferred lateral and rearward separation distance is 25 meters. If mines are placed in depth (from front to rear), the minimum rearward separation distance is 5 meters, provided secondary missiles are removed. This distance is sufficient to prevent possible disturbance or damage to the rearward mines.

**METHODS OF FIRE:** The M18A1 mine can be employed in either the controlled or uncontrolled role. In the controlled role, the mine is detonated by the operator as the forward edge of the enemy approaches a point within the killing zone (20 to 30 meters) where maximum casualties can be inflicted. Controlled detonation may be accomplished by use of either an electrical or a non-electrical firing system. When mines are employed in the controlled role, they are treated the same as

individual weapons and are reported for inclusion in the unit fire plan. They are not reported as mines; however, the emplacing unit must insure that the mines are either removed, detonated, or turned over to a relieving unit. Uncontrolled firing is accomplished when the mine is installed in such a manner as to cause an unsuspecting enemy to detonate the mine. Mines employed in this manner must be reported and recorded as land mines.

### FUNCTIONING

**Electrical Firing:** When the M18A1 is armed, actuating the M57 firing device handle with the safety bail in the FIRE position provides sufficient electrical energy to detonate the M6 electric blasting cap. The detonation of the blasting cap, in turn, sets off the high explosive charge (composition C4). Detonation of the high explosive charge causes fragmentation of the plastic matrix and projects spherical steel fragments outward in a fan-shaped pattern. This mine is sufficiently waterproof to function satisfactorily after having been submerged in salt or fresh water for 2 hours.

**Non-electrical Firing:** The M18A1 mine is deliberately detonated by the operator pulling or cutting a trip wire attached to a non-electrical firing device. A non-electric blasting cap attached to the firing device and crimped to a length of detonating cord sets off the detonating cord. At the other end of the detonating cord, a second crimped non-electric blasting cap, which is inserted in one of the detonator wells, detonates the mine.

**CAMOUFLAGE:** Although the M18A1 is painted olive-drab to facilitate camouflaging, it is necessary to blend the mine into its surroundings to prevent its detection. Only lightweight foliage, such as leaves and grass should be used to avoid increasing the secondary missile hazard to the rear of the mine. Both the front and rear of the mine should be camouflaged with foliage. The firing wire should also be camouflaged or buried underground. If used, detonating cord should not be buried; however, it may be covered with light foliage.

## 6-7. M240-B machine gun

**DESCRIPTION:** The M240B machine gun supports the rifleman in both offensive and defensive operations. The M240B provides the heavy volume of close and continuous fire needed to accomplish the mission. The M240B is used to engage targets beyond the range of individual weapons, with controlled and accurate fire. The long-range, close defensive, and final protective fires delivered by the M240B form an integral part of a unit's defensive fires.

The M240B is a general-purpose machine gun designed as a tripod mounted or bipod supported machine gun (see figure 6-31) for use by ground forces, which is integrated into the receiver assembly of the

TRADOC Pam 600-4

weapon. It can also be mounted on an aircraft or vehicle. The M240B is a belt-fed, air-cooled, gas-operated, fully automatic machine gun that fires from the open bolt position. Ammunition is fed into the weapon from a 100-round bandoleer containing a disintegrating metallic split-link belt. The gas from firing one round provides the energy for firing the next round. The gun functions automatically as long as it is supplied with ammunition and the trigger is held to the rear. As the gun is fired, the belt links separate and are ejected from the side. Empty cases are ejected from the bottom of the gun. A spare barrel is issued with each M240B, and barrels can be changed quickly as the weapon has a fixed head space. However, barrels from different weapons should not be interchanged. The bore of the barrel is chromium plated, reducing barrel wear to a minimum.

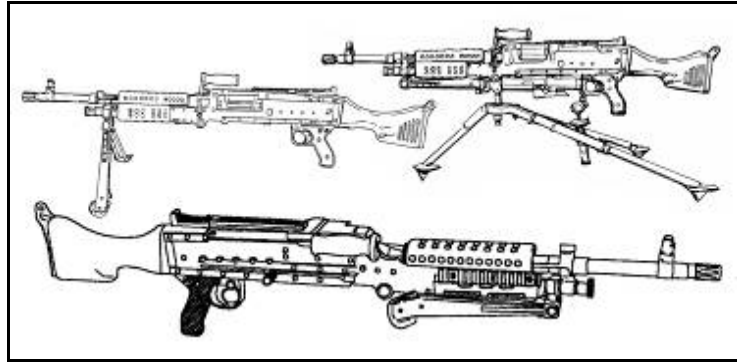

**Figure 6-31. M240B machine gun**

**TECHNICAL DATA**

Table 6-15 contains M240B machine gun technical data.

**Table 6-15**  
**M240B machine gun technical data**

<b>M240B Machine Gun Technical Data</b>	
Ammunition	7.62-mm ball, tracer, armor piercing, blank, dummy Armor-piercing round is not authorized for training
Tracer Burnout	900 meters
Length of the M240B	49 inches
Weight	27.6 pounds
Tripod-mount M122A1 Tripod with Flex-mount, Complete	20 pounds
Maximum Range	3,725 meters
Maximum Effective Range	1,100 meters with tripod and T&E
Area	
Tripod	1,100 meters
Bipod	800 meters
Point	
Tripod	800 meters
Bipod	600 meters



**Table 6-16****M240B machine gun technical data, continued**

<b>M240B Machine Gun Technical Data</b>	
Suppression	1,800 meters
Maximum Extent of Grazing Fire Obtainable Over Level or Uniformly Sloping Terrain	600 meters
Height of M240B on Tripod Mount M122A1	17.5 inches
<b>Rates of Fire</b>	
Sustained	100 rounds per minute fired in 6- to 9-round bursts and 4 to 5 seconds between bursts (barrel change every 10 minutes)
Rapid	200 rounds per minute fired in 10- to 13-round bursts and 2 to 3 seconds between bursts (barrel change every 2 minutes)
Cyclic	650 to 950 rounds per minute in continuous bursts (barrel change every minute)
Basic Ammunition Load (three-man crew)	900 to 1200 rounds
Elevation, Tripod Controlled	+247 mils
Elevation, Tripod Free	+300 mils
Depression, Tripod Controlled	-200 mils
Traverse, Controlled by T&E Mechanism	100 mils
Normal Sector of Fire (with tripod)	875 mils
Free Gun	6,400 mils

**MAJOR ASSEMBLIES:** The major assemblies for the M240B machine gun and M122A1 tripod assembly numbered and described below (see figure 6-32).

**Barrel assembly (1):** Consists of the barrel, flash suppressor, carrying handle, heat shield, front sight assembly, and gas-regulator plug. Houses the cartridge for firing and directs the projectile.

**Heat shield assembly (2):** Protects the gunner's hand from a hot barrel.

**Butt stock/buffer assembly, buffer, and spade grip assembly-but stock and buffer assembly (3):** Composite butt stock: buffer housing

that contains spring washers to absorb recoil from bolt and operating rod assembly at the end of recoil movement.

**Receiver assembly (4):** Consists of receiver, handguard, bipod, and rear sight assembly. Serves as support for all major components. Houses action of the weapon and, through a series of cam ways, controls function of weapon.

**Handguard assembly (not shown) (5):** Provides thermal insulation to protect the gunner's hands from heat or extreme cold.

**Cocking handle assembly (6):** Pulls the moving parts rearward. Moves in a guide rail fixed to the right side of the receiver.

**Trigger housing assembly (7):** Controls the firing of the machine gun. Contains trigger and safety components

**Sling and snap hook assembly (8):** Provides a means of carrying the weapon.

**Bipod (9):** Supports M240B machine gun in prone position.

**Drive spring rod assembly (10):** Provides energy for returning bolt and operating rod assembly to firing position.

**Bolt/operating rod assembly (11):** Provides feeding stripping, chambering, firing, extracting, and ejecting of cartridges using propellant gases for power.

**Cover assembly (12):** Feeds linked belt, positions, and holds cartridges in position for stripping, feeding, and chambering. Top rail configuration allows mounting of optical and electronic sights.

**Feed tray (13):** Serves as guide for positioning cartridge to assist in chambering. Has a slotted top to allow air to circulate around barrel for cooling purposes.

**M122A1 Tripod assembly (14):** The tripod T&E mount assembly is flexible, provides a stable mount, absorbs recoil, and improves accuracy.

**Fork Assembly (14a)**

**Pintle Mount (14b)**

Traversing and Elevating (T&E) Mechanism (14c)

**Tripod Leg Assembly (14d)**

**Trigger Housing Mounting Hole (14e)**

**Spring Pin (14f)**

**Quick Release Pin (14g)**

**Front Receiver Bushing (14h)**

**Pintle Assembly Slots (14i)**

**Ejection port (15):** Provides guide for ejection of spent cartridges.

**Front sight (16):** The front sight is attached to the barrel and can be adjusted for elevation and windage to allow the gunner to zero his weapon. Since the sight on the barrel is adjusted to zero the machine gun, both barrels must be zeroed before combat and training.

**Rear sight (17):** The rear sight is attached to the rear of the receiver and is marked for each 100 meters of range, from 200 to 800 meters on the upper surface of the leaf, and on the reverse side of the leaf from 800 to 1,800 meters.

**Safety mechanism (18):** The safety mechanism is located on the pistol grip just behind the trigger well. When the safety is pushed to the right, the letter "S" is visible indicating the weapon is on safe. When pushed to the left, the letter "F" is visible on the safety indicating the weapon is on fire. The safety can only be engaged when the bolt is in the rear position. On the "S" position, the bolt cannot be released to go forward.

**Ammunition adapter (19):** It is used on the M240B machine gun when firing. This adapter allows the gunner to use the 100-round carton and bandoleer. The ammunition adapter is fitted to the left side and under the feed tray of the receiver. When looking at the left side of the receiver, you will see a slot and a button under the feed tray. The gunner first attaches the bandoleer holder to the base of the adapter by inserting the tapered end (green plastic) of the holder into the adapter. Then the gunner opens the cover assembly, and raises the feed tray. He inserts the curved lip of the adapter assembly into the slot located in the rail on the left of the receiver, below the feed tray, depressing the lever on the adapter assembly, and pushing the assembly towards the receiver, until it is against the receiver. Release the lever to allow the adapter assembly to secure itself onto the button on the receiver.

**M24 Blank firing attachment (20):** The blank firing attachment is used on the M240B machine gun when blank cartridges are fired to simulate live firing during training where live firing is not practical. The blank firing attachment is used on the M240B machine gun when blank cartridges are fired to support MILES force-on-force operations to simulate live-fire exercises. The blank firing attachment fits any M240B barrel. The tube fits inside the flash suppressor with the remaining portion fitting over the outside of the flash suppressor, flush against the gun muzzle, and flush with the forward end of the flash suppressor.

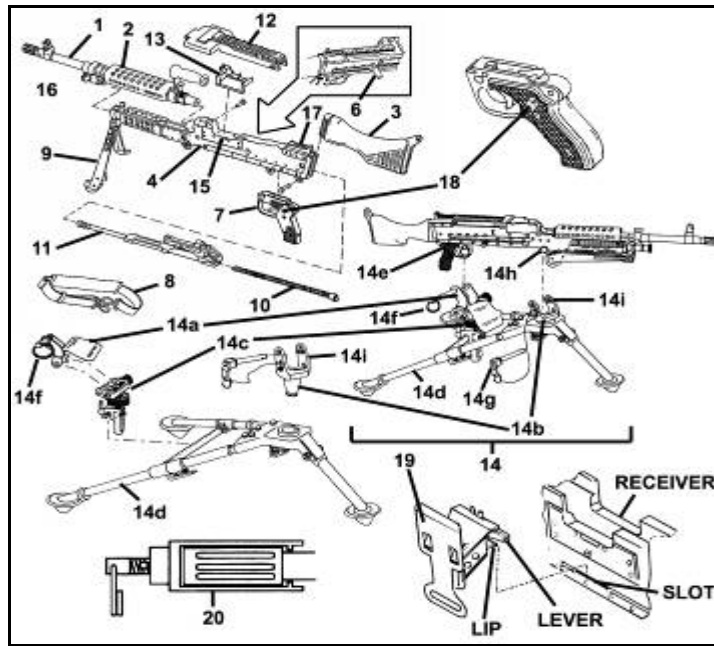

**Figure 6-32. M240B, M122A1 tripod assembly, ammunition adapter, and M24 blank firing attachment**

**AMMUNITION:** The M240B machine guns use several different types of 7.62-mm standard military ammunition. The specific type ammunition and its usage are listed in table 6-16 and shown in figure 6-33. Soldiers use only authorized ammunition that is manufactured to U.S. and NATO specifications. The ammunition is issued in a disintegrating, metallic, split-linked belt (see table 6-16).

**Table 6-16**

**M240B ammunition and usage**

<b>Ammunition</b>	<b>Usage</b>
(M61) 7.62-mm Armor-Piercing Cartridge	Lightly armored targets
(M80) 7.62-mm Ball Cartridge	Light materials and personnel Range training
(M62) 7.62-mm Tracer Cartridge	Observation of fire, incendiary effects, signaling, training When fired tracer rounds are mixed with ball ammunition in ratio of 4 ball rounds to 1 tracer round
(M63) 7.62-mm Dummy Cartridge	During mechanical training
(M82) 7.62-mm Blank Cartridge	During training when simulated live fire is desired Blank firing attachment should be used to fire this ammunition (see figure 6-34)

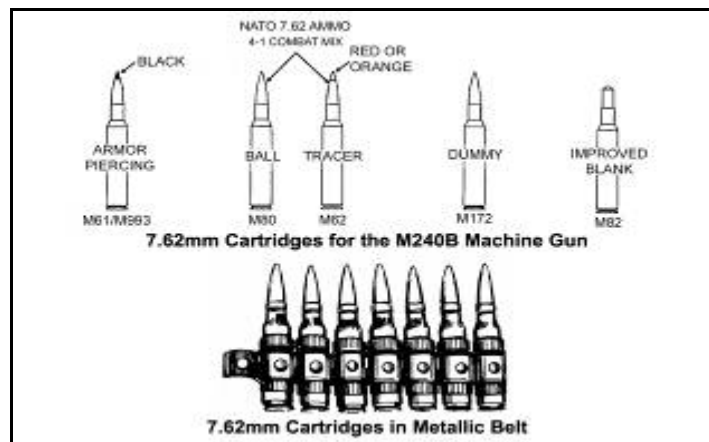

**Figure 6-33. M240B machine gun ammunition and metallic belt**

**6-8. Caliber .50 M2 machine gun**

**DESCRIPTION:** This weapon provides automatic weapon suppression fire for offensive and defensive purposes. This weapon can be used effectively against personnel, light armored vehicles, and low flying/slow flying aircraft. The caliber .50, M2 flexible version is used as a ground gun either on the M3 Tripod Mount or with the MK 93 Mod 0 Mount (see figure 6-34) on the M3 Tripod. The caliber .50, M2, M48 turret type, fixed type, and soft mount are installed on mounts of several different types of combat vehicles and ships.

You first open the feed tray cover, place the weapon on safe, insert a round, and close the feed tray cover. Keep muzzle pointed at target and move the safety from the safe to the fire position. Align the front and rear sight with the target and squeeze the trigger. Squeezing the trigger releases the firing pin and allows it to impact the primer on the round. The primer ignites the propellant in the round. Gas from the burning propellant pushes the projectile along the barrel of the bolt/receiver. The rifling in the barrel causes the projectile to rotate, which provides stability during flight to the target.

### WEAPON VARIATIONS

**Caliber .50 machine gun, M2, Heavy Barrel, Flexible:** A belt-fed, recoil operated, air-cooled, crew-served machine gun capable of firing single-shot and automatic (see figure 6-34). It is capable of right and left-hand feed. It is used as a ground gun mounted on the M3 Tripod, MK 56 Mod 0 and four gun mounts (Navy), MK 93 Mod 0 and Mod 1 mounts, or is installed on the M66 ring mount of several different types of combat vehicles.

**Caliber .50 machine gun, M2, Heavy Barrel, M48 Turret Type:** It is an air-cooled, recoil operated, alternate-feed, automatic, crew-served weapon mounted on the M1 and M1A1 Abram's main battle tank commander's station (see figure 6-34).

**Caliber .50 machine gun, M2, Heavy Barrel, Soft Mount Type:** A belt-fed, recoil operated, air-cooled, crew-served machine gun mounted on the MK 26 Mod 15, 16, and 17 gun mounts.

**Caliber .50 machine gun, M2, Heavy Barrel, Fixed Type:** A belt-fed, recoil operated, air-cooled, crew-served machine gun mounted on the MK 56 Mod 0 and 4 gun mounts. It is primarily fired by solenoid and requires a 24-28 Volts DC power source.

### MOUNT VARIATIONS

**M3 Tripod Mount:** A lightweight, portable folding mount that permits a high degree of accuracy and control of fire (see figure 6-34).

**MK 93 Mod 0 Mount:** An advanced soft recoil (for M2) dual purpose cradle mount to be used on the M3 Tripod or as part of the high mobility multipurpose wheeled vehicle with a vehicle mount MK 93 Mod 1 (see figure 6-34).

**MK 93 Mod 1 Mount:** Includes the carriage (MK 93 Mod 0), 40-mm ammunition can bracket, .50 Cal ammunition bracket, traversing and elevating mechanism, universal pintle adapter, and the catch bag assembly (see figure 6-34).

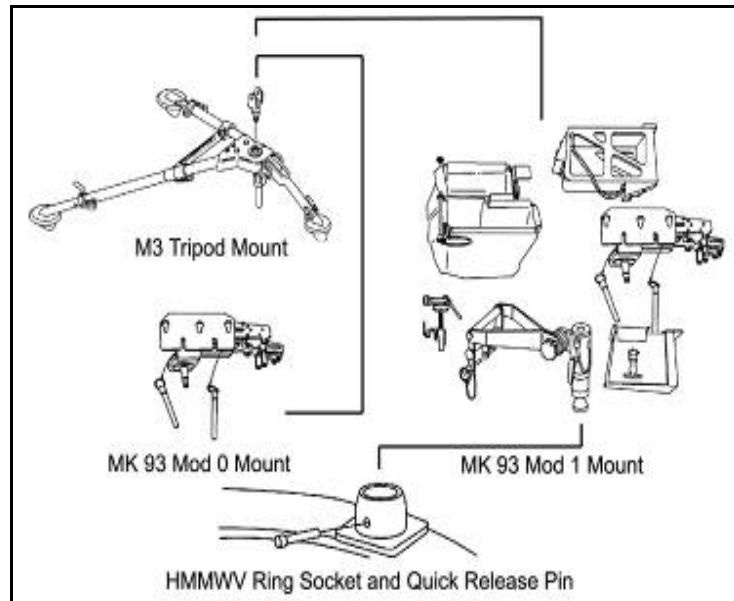

Figure 6-34. Caliber .50 machine gun, M2 mounts

**MAJOR COMPONENTS (CALIBER .50 MACHINE GUN, M2, HEAVY BARREL, FLEXIBLE TYPE)**

**Buffer Tube Sleeve (1):** Locks the bolt latch release in the open position to permit the machine gun to fire automatic or the unlocked position for single shot (flexible type only).

**Trigger (2):** Controls the firing of the machine gun.

**Back Plate (3):** Houses the trigger and buffer tube.

**Rear (4) and Front (6) Sights:** They zero and accurately sight the machine gun (flexible type only).

**Cover (5):** Feeds the belt and positions and holds the cartridges for chambering.

**Barrel (7):** Has rifling to give bullet spin for accuracy and a chamber for firing the cartridge.

**Receiver (8):** Houses the internal components of the machine gun and serves as support for the entire machine gun.

**Retracting Slide Handle (9):** Used for cocking the machine gun (flexible type and soft mount type only).

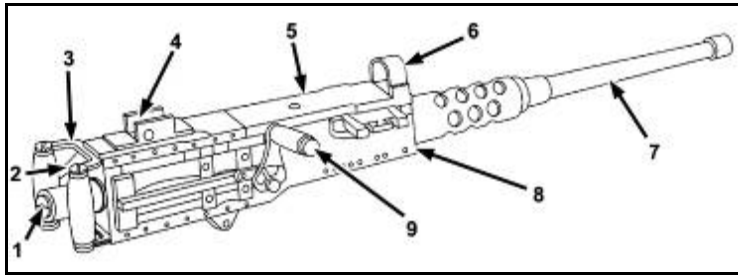

**Figure 6-35. Caliber .50 machine gun, M2, heavy barrel, M48 flexible type**

**MAJOR COMPONENTS (CALIBER .50 MACHINE GUN, M2, HEAVY BARREL, M48 TURRET TYPE) (Figure 6-36)**

**Cover (1):** Feeds the belt and positions and holds the cartridges for chambering.

**Backplate (2):** Houses trigger and buffer tube.

**Trigger (3):** Controls the firing of the machine gun.

**Buffer Tube Sleeve (4):** Locks the bolt latch release in the open position to permit the machine gun to fire automatic or the unlocked position for single shot.

**Safety (5):** Slides to select fire or no fire (M48 turret type and fixed type only).

**M10 Manual Charger (7) and Charging Handle (6):** Has a cable and charging handle for cocking the machine gun (M48 turret type and fixed type only).

**Receiver (8):** Houses the internal components of the machine gun and serves as support for the entire machine gun.

**Barrel (9):** Has rifling to give bullet spin for accuracy and a chamber for firing the cartridge.

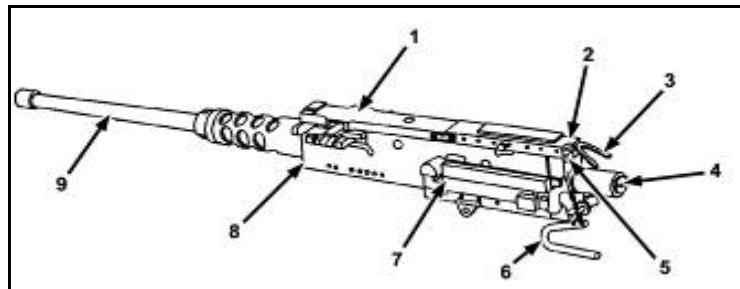

**Figure 6-36. Caliber .50 machine gun, M2, heavy barrel, M48 turret type**



**Table 6-17****.50 M2 machine gun technical data**

<b>.50 M2 Machine Gun Technical Data</b>	
Weight of Gun (approx)	84 lbs (38.10 kg)
Weight of Barrel	26 lbs (11.79 kg)
Length of Gun	65.13 in. (165.43 cm)
Length of Barrel	45 in. (114.30 cm)
Length of Rifling (approx)	41.88 in. (106.38 cm)
Number of Lands and Grooves	8
Twist, Right-hand	One turn is 15 in. (38.10 cm)
Feed	Link-belt
Operation	Short recoil
Cooling	Air
Muzzle Velocity (approx)	3,050 fps (929.64 mps)
Maximum Range (approx)	7,400 yds (6,767 m)
Maximum Effective Range (approx)	2,000 yds (1,829 m)

**AMMUNITION:** This is the only ammunition authorized for use in your machine gun. If it is not shown, it is not authorized. Because of the potential injury from discarding sabot fragments, neither the M903 nor the M962 should be fired over the heads of friendly personnel (see figure 6-37).

**Normal training mix:** 4 ball M2/M33 and 1 tracer M17 with M9 link.

**Normal combat mix:** 4 ball API-M8 and 1 APIT M20 with M9 link.

**Normal combat mix:** 4 SLAP M903 and 1 SLAP M962 with M9 link.  
(NOT TO BE USED WITH THE UNLINED BARREL)

**NOTE:** All cartridges except the M2 DUMMY have plain cases.

**NOTE:** M1A1 blank is to be utilized with the M19 blank firing attachment.

The sights on the M2 machine gun are designed for conventional ball, tracer, and armor-piercing incendiary ammunition (see figure 6-37). SLAP ammunition is NOT to be fired with the unlined barrel; damage to the unlined barrel will occur. Use lined barrel, part number 7266131. If barrel does not have part number 7266131 marked on the outside of barrel, do NOT fire SLAP ammunition. Firing of the SLAP cartridges with the current sight will result in the projectile having a higher trajectory than desired. For targets at 1,000 meters or less, align the sights on the target and then drop two clicks on the sight or traversing and elevating mechanism. For targets beyond 1,000 meters, align the sights and come down three clicks.

**.50 M 2 Machine Gun Rates of Fire:**

**Single Shot:** Place gun in single shot mode and engage target with well aimed shots. The .50 caliber machine gun is extremely accurate and can effectively engage targets out to 2,000 yards (1,829m). Change the barrel at end of firing day or if the barrel is damaged.

**Slow Fire:** Slow fire is less than 40 rounds per minute, fired in bursts of 6 to 9 rounds, at 10-15 second intervals. Change the barrel at the end of the firing day or if the barrel is damaged.

**Rapid Fire:** Rapid fire is greater than 40 rounds per minute, fired in bursts of 6 to 9 rounds, at 5-10 second intervals. Change the barrel at the end of the firing day or if the barrel is damaged.

**Cyclic Fire:** This rate represents the maximum amount of ammunition that can be expended by a gun without a break in firing. The cyclic rate of this .50 caliber machine gun is 450 to 600 rounds per minute. Change the barrel at the end of the firing day or if the barrel is damaged.

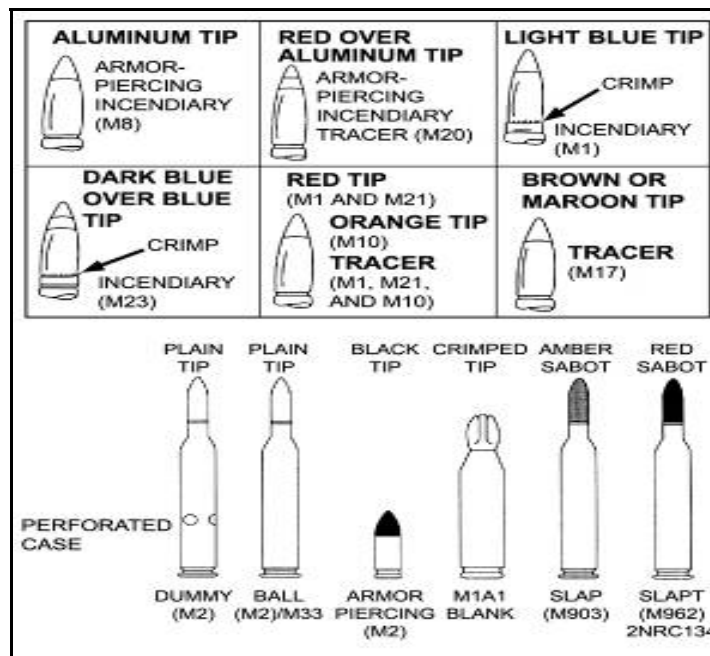

Figure 6-37. Authorized .50 M2 machine gun ammunition

**THIS PAGE LEFT BLANK INTENTIONALLY.**

## Chapter 7 Modern Army Combatives

### 7-1. Modern Army combatives principles

a. Hand-to-hand combat is an engagement between two or more persons in an empty-handed struggle or with handheld weapons such as knives, sticks, or projectile weapons that cannot be fired.

(1) These fighting arts are essential military skills.

(2) Projectile weapons may be lost or broken, or they may fail to fire.

(3) When friendly and enemy forces become so intermingled that firearms and grenades are not practical, hand-to-hand combat skills become vital assets.

b. Today's battlefield scenarios may require silent elimination of the enemy.

(1) Unarmed combat and expedient-weapons training should not be limited to forward units.

(2) With rapid mechanized/motorized, airborne, and air assault abilities, units throughout the battle area could be faced with close quarter or unarmed fighting situations.

(3) With low-intensity conflict scenarios and guerrilla warfare conditions, any Soldier is apt to face an unarmed confrontation with the enemy, and hand-to-hand combative training can save lives.

(4) The many practical battlefield benefits of combative training are not its only advantage.

(5) It can also contribute to individual and unit strength, flexibility, balance, cardio respiratory fitness, confidence, self-discipline, and esprit de corps.

c. There are eight basic principles that the hand-to-hand fighter must know and apply to successfully defeat an opponent.

**NOTE:** Although not covered here, there are many other guidelines involved, which, through years of study, become intuitive to a highly skilled fighter.

(1) Mental calm: during a fight a Soldier must keep his ability to think. He must not allow fear of anger to control his actions.

(2) Situational awareness: Things are often going on around the fighter that could have a direct impact on the outcome of the fight such as opportunity weapons or other personnel joining the fight.

(3) Suppleness: a Soldier cannot always count on being bigger and stronger than the enemy. He should, therefore, never try to oppose the enemy in a direct test of strength. Supple misdirection of the enemy's strength allows superior technique and fight strategy to overcome superior strength.

(4) Base: Base refers to the posture that allows a Soldier to gain leverage from the ground. Generally, a Soldier must keep his center of gravity low and his base wide much like a pyramid.

(5) **Dominant Body Position:** Position refers to the location of the fighter's body in relation to his opponents. A vital principle when fighting is to gain control of the enemy by controlling this relationship. Before any killing or disabling technique can be applied, the Soldier must first gain and maintain one of the dominant body positions (see figures 7-1 through 7-5).

(6) **Distance:** Each technique has a window of effectiveness based upon the amount of space between the two combatants. The fighter must control the distance between himself and the enemy in order to control the fight.

(7) **Physical Balance:** Balance refers to the ability to maintain equilibrium and to remain in a stable upright position.

(8) **Leverage:** A fighter uses parts of his body to create a natural mechanical advantage over the parts of the enemy's body. By using leverage, a fighter can have a greater effect on a much larger enemy.

## 7-2. Modern Army combatives: dominant body positions

a. The back mount (see figure 7-1) is the most dominant body position because it gives you the best control of the fight. The position allows you to strike and submit your enemy, while your opponent has few offensive options.



**Figure 7-1. Back mount**

(1) Both fighters will be seated on the ground with the dominant fighter facing his opponent's back.

(2) Both legs should be wrapped around your opponent with the heels hooked inside the legs. This will keep your hips tight around the enemy to prevent him from working out of the position.

**WARNING:** Do not interlock your ankles (this will provide your opponent an opportunity for an ankle break).

(3) Place one arm under an armpit and the other around the neck to control the enemy's upper body.

(4) Clasp your hands together in an opposing thumbs grip to help prevent him from tearing at your fingers and breaking your hold to escape.

(5) Tuck your head down near your over hook side arm. This way, when your opponent throws elbows back toward your head, he will not strike your face.

b. The mount position (see figure 7-2) is achieved when the dominant fighter is sitting on his enemy's abdomen or chest with both feet and knees on the ground next to the opponent's ribs and hips. This affords the dominant fighter an opportunity to strike at will, as the range is clearly in his favor, and utilize submissions as he has the leverage. The fighter on the bottom in the non-dominant body position suffers from a lack range and must continually defend against submissions from chokes, joint, and muscle manipulation.



**Figure 7-2. Front mount**

(1) The non-dominant fighter is laying on his back with his knees bent and both feet posted on the ground. His elbows are drawn in tight to his sides and are on the ground to prevent his opponent from riding up into a high mount.

(2) You are sitting on your opponent's chest or abdomen with both feet and knees on the ground.

**NOTE: WARNING.** Place your toes in line with or inside of your ankles when on top in the mount to mitigate the risk of injuring your ankles when your opponent attempts to roll you over.

(3) Your knees are as high as possible toward your opponent's armpits to mitigate his ability to arch his hips and break your posture.

(4) Hold this position loosely to allow your opponent to turn over if he should try.

(5) The non-dominant fighter must keep both knees bent and feet posted on the ground to allow him to arch his hips. His elbows must stay in and on the ground to keep you from driving your knees toward

the armpits. The non-dominant fighter has to keep his head off the ground, so when struck, damage will be limited.



**Figure 7-3. Guard**

c. You never want to fight off your back. However, the guard position (see figure 7-3) will allow you to transition off your back into a more advantageous position. The guard position allows the bottom fighter to exercise a certain amount of control over the range by pushing out or pulling in the enemy with his legs and hips. However, while both fighters can strike each other, the top fighter has the advantage of punching downward. The bottom fighter enjoys the advantage of being able to submit his enemy.

(1) The non-dominant fighter will start off in a kneeling position with both knees and feet on the ground.

**NOTE: WARNING.** Place your toes in line with or inside of your ankles when on top in the guard position to mitigate the risk of injuring your ankles when your opponent attempts to sweep you over.

(2) You are on your back.

(3) Control your opponent's body by locking your legs around his torso and controlling his arms at the elbows.

(4) When you are locked in your opponent's guard, establish a wide base with your knees, keeping your toes inside of your ankles to prevent breaking them during a sweep. Place your hands on your opponent's hip flexors, with your elbows turned inward, and waist straight.



**Figure 7-4. Side control**

d. The side control position (see figures 7-4 and 7-4) is by its nature less dominant. However, it allows you to hold the enemy down and inflict enough damage to successfully transition to a more dominant position.

(1) The non-dominant fighter will be lying belly up on the ground with his knees bent and feet posted on the ground. The arm closest to the dominant fighter's head will hide his arm under his opponent's armpit. The arm closest to his enemy's hips will form a table top placed against.

(2) Put your elbow on the ground between your opponent's ear and shoulder (elbow notch) to prevent him from simply pushing you back over his lower body. Place your weight down on your enemy, keeping your hips low the entire time.



**Figure 7-5. Side control**

(3) Control your enemy's hips by pinching your backside knee and other elbow together to prevent him from threading his legs into you to compose guard, or turning his hips away from you to tripod to single leg.

(4) Secure and maintain chest-to-chest contact with your opponent.

(5) Straighten your leg nearest his head by pushing forward on the toe and keeping your knee off the ground. Use this pressure to push your hips down to enable better control.



**7-3. Modern Army combatives: rifle with fixed bayonet**

a. The principles used in fighting with the rifle and fixed bayonet are the same as when knife fighting.

(1) Use the same angles of attack and similar body movements.

(2) The principles of timing and distance remain paramount. The main difference is the extended distance provided by the length of the weapon.

(3) It is imperative that the Soldier fighting with rifle and fixed bayonet use the movement of his entire body behind all of his fighting techniques—not just upper-body strength.

(4) Unit trainers should be especially conscious of stressing full body mass in motion for power and correcting all deficiencies during training.

(5) Whether the enemy is armed or unarmed, a Soldier fighting with rifle and fixed bayonet must develop the mental attitude that he will survive the fight.

(6) He must continuously evaluate each moment in a fight to determine his advantages or options, as well as the enemy's.

(7) He should base his defenses on keeping his body moving and off the line of any attacks from his opponent.

(8) The Soldier seeks openings in the enemy's defenses and starts his own attacks, using all available body weapons and angles of attack.

b. Rifle/bayonet fighting techniques continue to evolve as new weapons, improved equipment, and new tactics are introduced.

(1) Firepower alone will not always drive a determined enemy from his position.

(2) He will often remain in defensive emplacements until driven out by close combat.

(3) The role of the Soldier, particularly in the final phase of the assault, remains relatively unchanged.

(4) His mission is to close with and disable or capture the enemy.

(5) This mission remains the ultimate goal of all individual training.

(6) The rifle with fixed bayonet is one of the final means of defeating an opponent in an assault.

(7) During infiltration missions at night or when secrecy must be maintained, the bayonet is an excellent silent weapon.

(8) When close-in fighting determines the use of small-arms fire or grenades to be impractical, or when the situation does not permit the loading or reloading of the rifle, the bayonet is still the weapon available to the Soldier.

(9) The bayonet serves as a secondary weapon should the rifle develop a stoppage.

(10) In hand-to-hand encounters, the detached bayonet may be used as a handheld weapon.

(11) The bayonet has many non-fighting uses. It is used to probe for mines, cut vegetation, and for other tasks where a pointed or cutting tool is needed.

- c. Development of rifle/bayonet fighting skills is required to become a successful rifle-bayonet fighter.
- (1) A Soldier must be physically fit and mentally alert.
  - (2) A well-rounded physical training program will increase his chances of survival in a bayonet encounter.
  - (3) Mental alertness entails being able to quickly detect and meet an opponent's attack from any direction.
  - (4) Aggressiveness, accuracy, balance, and speed are essential in training as well as in combat situations.
  - (5) These traits lead to confidence, coordination, strength, and endurance, which characterize the rifle-bayonet fighter.
  - (6) Differences in individual body physique may require slight changes from the described rifle-bayonet techniques.
  - (7) These variations will be allowed if the individual's attack is effective.
- d. Rifle/bayonet principles should be followed when engaging in this type of combat. Some of these principles follow:
- (1) The bayonet is an effective weapon to be used aggressively—hesitation may mean sudden death.
  - (2) The Soldier must attack in a relentless assault until his opponent is disabled or captured.
  - (3) He should be alert to take advantage of any opening.
  - (4) If the opponent fails to present an opening, the bayonet fighter must make one by parrying his opponent's weapon and driving his blade or rifle butt into the opponent with force.
  - (5) The attack should be made to a vulnerable part of the body—face, throat, chest, abdomen, or groin.
  - (6) In both training and combat, the rifle-bayonet fighter displays spirit by sounding off with a low and aggressive growl.
  - (7) This instills a feeling of confidence in his ability to close with and disable or capture the enemy.
  - (8) The instinctive rifle-bayonet fighting system is designed to capitalize on the natural agility and combatives movements of the Soldier.
  - (9) It must be emphasized that precise learned movements will NOT be stressed during training.
- e. Maintaining proper rifle/bayonet **fighting positions** are key to success.
- (1) The Soldier must hold the rifle firmly but not rigidly.
  - (2) He must relax all muscles not used in a specific position—tense muscles may cause fatigue and slow him down.
  - (3) After proper training and thorough practice, the Soldier instinctively assumes the basic positions.
  - (4) All positions and movements described in this handbook are for right-handed men.

(5) A left-handed man, or a man who desires to learn left-handed techniques, must use the opposite hand and foot for each movement phase described.

(6) All positions and movements can be executed with or without the magazine or sling attached.

(a) **Attack position** is the basic starting position (see figure 7-6) from which all attack movements originate.

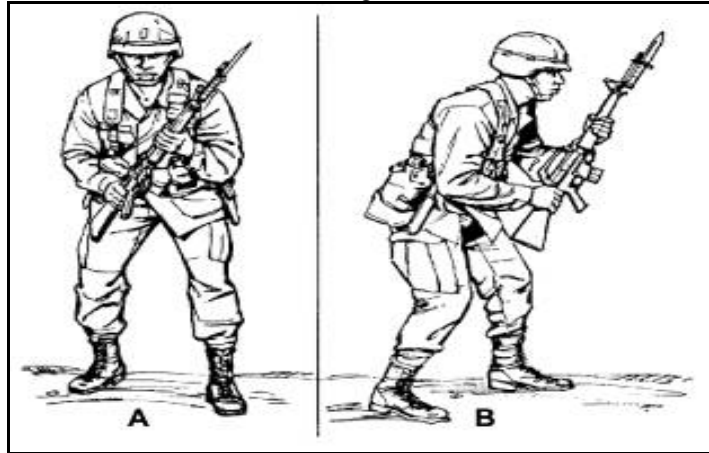

**Figure 7-6. Attack position**

- The attack position generally parallels a boxer's stance.
- The Soldier assumes this position when running or hurdling obstacles.
- The instructor explains and demonstrates each move.
- Take a step forward and to the side with your left foot so that your feet are a comfortable distance apart.
- Hold your body erect or bend slightly forward at the waist.
- Flex your knees and balance your body weight on the balls of your feet.
- Your right forearm is roughly parallel to the ground.
- Hold the left arm high, generally in front of the left shoulder.
- Maintain eye-to-eye contact with your opponent, watching his weapon and body through peripheral vision.
- Hold your rifle diagonally across your body at a sufficient distance from the body to add balance and protect you from enemy blows.
- Grasp the weapon in your left hand just below the upper sling swivel, and place the right hand at the small of the stock.
- Keep the sling facing outward and the cutting edge of the bayonet toward your opponent.
- The command is "Attack position, move."
- The instructor gives the command, and the Soldiers perform the movement.

(b) **Relaxed position** gives the Soldier a chance to rest during training (see figure 7-7).



**Figure 7-7. Relaxed position**

- The relaxed position also allows a Soldier to direct his attention toward the instructor as he discusses and demonstrates the positions and movements.

- To assume the relaxed position from the attack position:

- Straighten the waist and knees and lower the rifle across the front of your body by extending the arms downward.
- The command is “Relax.”
- The instructor gives the command, and the Soldiers perform the movement.

(c) **Movements** involve the Soldier instinctively striking at openings and becoming aggressive in his attack.

- Movements are attempted once he has learned to relax, and he has developed instinctive reflexes.

- His movements do not have to be executed in any prescribed order.

- He will achieve balance in his movements, be ready to strike in any direction, and keep striking until he has disabled his opponent.

- There are two basic movements used throughout bayonet instruction—the whirl and the crossover.

- These movements develop instant reaction to commands and afford the instructor maximum control of the training formation while on the training field.

(d) **Whirl movement** allows the rifle-bayonet fighter (when properly executed) to meet a challenge from an opponent attacking him

from the rear (see figure 7-8). At the completion of a whirl, the Soldier remains in the attack position.

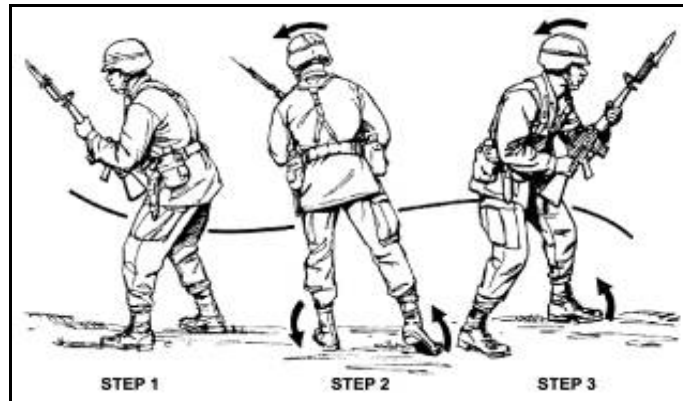

**Figure 7-8. Whirl movement**

(1) The rifle instructor explains and demonstrates how to spin your body around by pivoting on the ball of the leading foot in the direction of the leading foot and facing completely about.

(2) The command is, WHIRL.

(3) The instructor gives the command, and the Soldiers perform the movement.

(4) **Crossover movement** is used to separate ranks at a safe distance during rifle-bayonet training.

- When the Soldiers in ranks come too close to each other to safely execute additional movements, the crossover is used to separate the ranks a safe distance apart.

- The instructor explains and demonstrates how to move straight forward and pass an opponent so the Soldier's right shoulder passes the opponent's right shoulder, continues moving forward (about six steps), halts, then without command, executes a whirl.

- Remain in the attack position and wait for further commands.

- The command is, CROSSOVER.

- The instructor gives the command, and the Soldiers perform the movement.

**NOTE:** Left-handed personnel cross left shoulder to left shoulder.

(e) **Attack movements** designed to disable or capture the opponent, include thrust, butt stroke, slash, and smash.

- Each of these movements may be used for the initial attack or as a follow-up should the initial movement fail to find its mark.

- Soldiers learn these movements separately.

- Continual training will enable Soldiers to execute these movements in a swift and continuous series.

- During all training, the emphasis will be on conducting natural, balanced movements to effectively damage the target.
  - Precise, learned movements will not be stressed.
- (f) **Defensive movements** are needed at times when the Soldier loses the initiative and is forced to defend himself.
- He may also meet an opponent who does not present a vulnerable area to attack.
  - Therefore, he must make an opening by initiating a parry or block movement, then follow up with a vicious attack.
  - The follow-up attack is immediate and violent.
  - All training will stress damage to the target and violent action, using natural movements as opposed to precise, stereotyped movements.
  - Instinctive, aggressive action and balance are the keys to offense with the rifle and bayonet.

**THIS PAGE LEFT BLANK INTENTIONALLY.**

**Chapter 8**  
**Tactics**

**8-1. Fire team formations**

- a. **Fire team formations** are arrangements of elements and Soldiers in relation to each other.
  - (1) Squads use formations for control, flexibility, and security.
  - (2) Leaders choose formations based on their analysis of the factors of mission, enemy, terrain, troops, and time (METT-T).
  - (3) Table 8-1 compares fire team wedge and file formations.
  - (4) Fire team leaders are up front in formations to lead by example, "Follow me and do as I do."
  - (5) All Soldiers in the team must be able to see their leader.
  - (6) Wedge - the wedge is the basic formation for the fire team (see figure 8-1).

**Table 8-1**  
**Fire team formation characteristics**

<b>Fire Team Wedge</b>	
When Normally Used	Basic fire team formation
Control	Easy
Flexibility	Good
Fire Capabilities and Restrictions	Allows immediate fires in all directions
Security	Good
<b>Fire Team File</b>	
When Normally Used	Close terrain, dense vegetation, limited visibility conditions
Control	Easiest
Flexibility	Less flexible than the wedge
Fire Capabilities and Restrictions	Allows immediate fires to the flanks, masks most fires to the rear
Security	Least

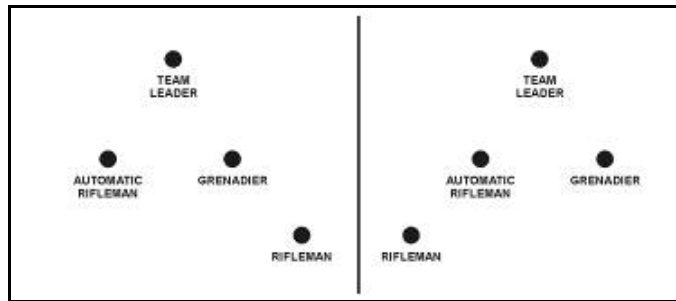

**Figure 8-1. Fire team wedge formation**



## TRADOC Pam 600-4

- (a) The interval between Soldiers in the wedge formation is normally 10 meters.
- (b) The wedge expands and contracts depending on the terrain.
- (c) When rough terrain, poor visibility, or other factors make control of the wedge difficult, fire teams modify the wedge.
- (d) The normal interval is reduced so that all team members can still see their team leader and team leaders can see their squad leader.
- (e) The sides of the wedge can contract to the point where the wedge resembles a single file.
- (f) When moving in less rugged terrain, where control is easier, Soldiers expand or resume their original positions.
- (7) **File** formation is used by fire teams when terrain precludes use of the wedge (see figure 8-2).



**Figure 8-2. Fire team file formation**

### **8-2. Serve as a member of a team**

- a. The Army defines team as a "group of individuals banded together along organizational lines for the purpose of accomplishing a certain goal."
- b. Cohesion is the "glue" that brings people together to make a team. It helps Soldiers to develop and sustain their commitment and resolve to accomplish the unit's mission. The Army's description of cohesion includes these elements:
  - (1) Bonding: "The development of strong interpersonal relationships among Soldiers, and between them and their leaders."
  - (2) Commitment: "Dedication not only to the unit and what it represents, but to the values and goals of the Nation as well."
  - (3) Resolve: "The shared determination of Soldiers and their leaders to work interdependently to accomplish the mission, and to sustain this capability over a long period of time."
- c. Cohesion is dependent on several factors:
  - (1) Common goal.
  - (2) People working together.
  - (3) Effective communication.

(4) Mutual assistance.

**8-3. Squad formations**

a. **Rifle squad:** The most common rifle squad has nine Soldiers (see figure 8-3).

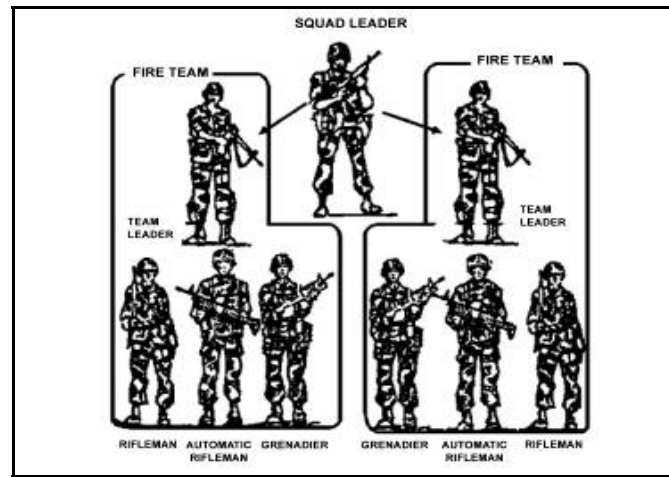

**Figure 8-3. Rifle squad**

- (1) The rifle squad fights as two fire teams.
  - (2) The squad has one squad leader, two fire team leaders, two automatic riflemen, two riflemen, and two grenadiers.
- b. **Squad formations** describe the relationships between fire teams in the squad.
- (1) **Squad column:** The squad column is the squad's most common formation (see figure 8-4).

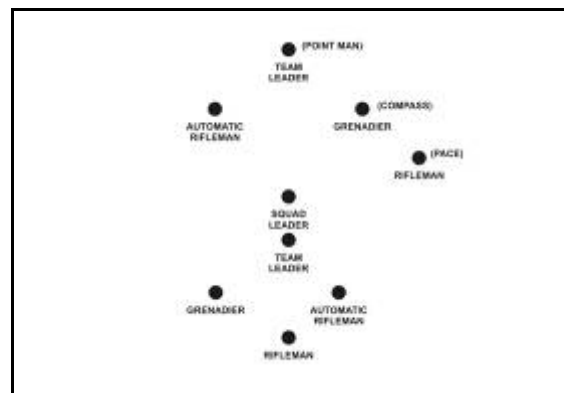

**Figure 8-4. Squad column with fire teams in column**

TRADOC Pam 600-4

- (a) The squad column provides good dispersion laterally and in depth without sacrificing control, and it facilitates maneuver.
  - (b) The lead fire team is the base fire team.
  - (c) When the squad moves independently or as the rear element of the platoon, the rifleman in the rear fire team provides rear security.
- (2) **Squad line:** The squad line provides maximum firepower to the front (see figure 8-5). When a squad is acting as the base squad, the fire team on the right is the base fire team.

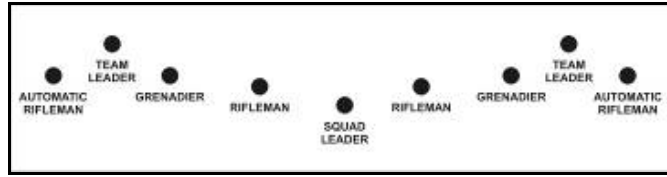

Figure 8-5. Squad line

- (3) **Squad file:** When not traveling in a column or line, squads travel in file (see figure 8-6).

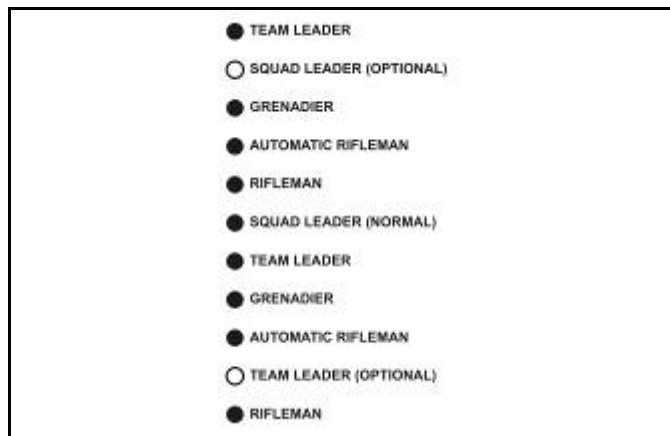

Figure 8-6. Squad file

- (a) The squad file has the same characteristics as the fire team file.
  - (b) When the squad leader desires to increase his control over the formation, he can move forward from second to first position. Once forward, he will be immediately available to make key decisions and will exert greater morale presence.
  - (c) Additional control over the rear of the formation can be provided by moving a team leader to the last position.
- (4) A comparison of squad formation characteristics is found in table 8-2.

**Table 8-2**  
**Squad formation characteristics**

<b>Squad Formation Characteristics</b>	
<b>Squad Column</b>	
When Normally Used	Squad primary formation
Control	Good
Flexibility	Facilitates maneuver Good dispersion laterally and in depth
Fire Capabilities and Restrictions	Allows large volume of fire to the flank Limited volume to the front
Security	All-round
<b>Squad Line</b>	
When Normally Used	When maximum fire power is required in front
Control	Not as good as squad column
Flexibility	Limited maneuver capability (both fire teams committed)
Fire Capabilities and Restrictions	Allows maximum immediate fire to the front
Security	Good to the front Little to the flanks and rear
<b>Squad File</b>	
When Normally Used	Close terrain, vegetation, limited visibility conditions
Control	Easiest
Flexibility	Most difficult formation from which to maneuver
Fire Capabilities and Restrictions	Allows immediate fire to the flank Masks most fire to front and rear
Security	Least

#### **8-4. Fire team/squad movement techniques**

a. A **movement technique** is the manner a squad uses to traverse terrain.

(1) The selection of a movement technique is based on the likelihood of enemy contact and the need for speed.

(2) Factors to consider for each technique are control, dispersion, speed, and security (see table 8-3).

**Table 8-3****Movement technique characteristics**

<b>Traveling</b>	
When Normally Used	Contact not likely
Control	More
Dispersion	Less
Speed	Fastest
Security	Least
<b>Traveling Overwatch</b>	
When Normally Used	Contact possible
Control	Less
Dispersion	More
Speed	Slower
Security	More
<b>Bounding Overwatch</b>	
When Normally Used	Contact expected
Control	Most
Dispersion	Most
Speed	Slowest
Security	Most

(3) Movement techniques are not fixed formations and can be used with any formation.

(4) Movement techniques refer to the distances between Soldiers and teams that vary based on mission, enemy, terrain, visibility, and any other factor that affects control.

(5) Soldiers must be able to see their fire team leader.

(6) The squad leader must be able to see his fire team leaders.

(7) Leaders control movement with arm-and-hand signals, and they use radios only when needed.

(8) The platoon leader determines and directs which movement technique the squad will use.

b. There are three movement techniques: traveling, traveling overwatch, and bounding overwatch.

(1) Traveling is used when contact with the enemy is not likely and speed is needed ( see figure 8-7).

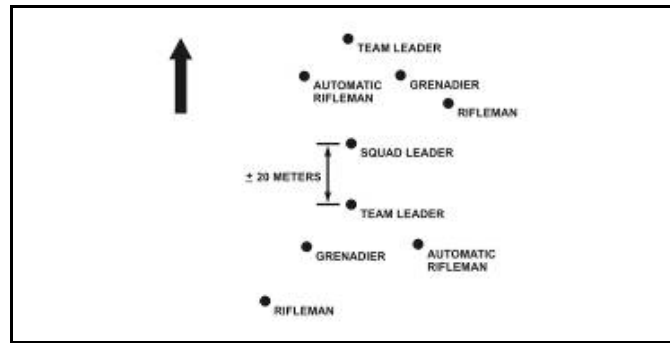

**Figure 8-7. Squad traveling**

(2) **Traveling overwatch** is used when contact is possible (see figure 8-8). Attached weapons move near the squad leader and under his control so he can employ them quickly.

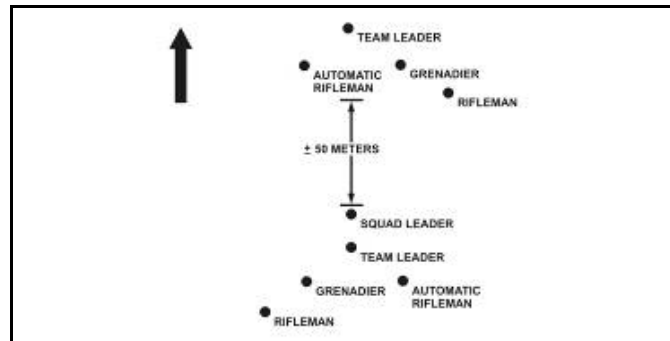

**Figure 8-8. Squad traveling overwatch**

(3) **Bounding overwatch** is used when contact is expected, when the squad leader feels the enemy is near (movement, noise, reflection, trash, fresh tracks, or even a hunch), or when a large open danger area must be crossed (see figure 8-9).

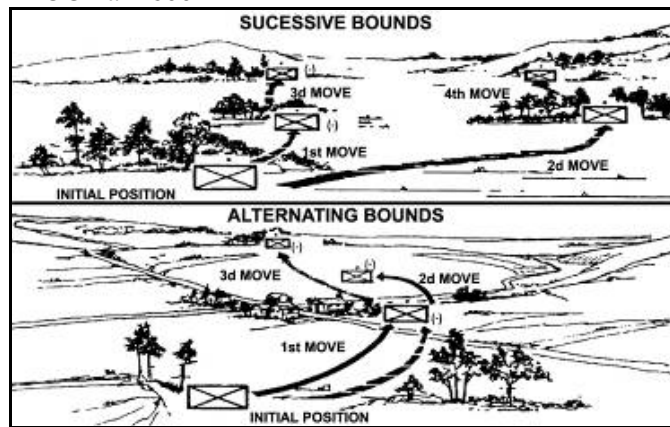

Figure 8-9. Squad successive and alternating bounds

- (a) The lead fire team overwatches first.
- (b) Soldiers scan for enemy positions.
- (c) The squad leader usually stays with the overwatch team.
- (d) The trail fire team bounds and signals the squad leader when his team completes its bound and is prepared to overwatch the movement of the other team.
- (e) Both team leaders must know if successive or alternate bounds will be used and which team the squad leader will be with.
- (f) The overwatching team leader must know the route and destination of the bounding team.
- (g) The bounding team leader must know his team's destination and route, possible enemy locations, and actions to take when he arrives there.
- (h) He must also know where the overwatching team will be, and how he will receive his instructions.
- (i) The cover and concealment on the bounding team's route dictates how its Soldiers move.
- (j) Teams can bound successively or alternately.
- (k) Successive bounds are easier to control.
- (l) Alternate bounds can be faster. (see figure 8-9).

### 8-5. Fighting positions

- a. Infantrymen use a variety of hasty fighting positions: one-Soldier, two-Soldier, three-Soldier, machine gun, medium and light antitank, and 90-mm recoilless rifle.
- b. Soldiers must construct fighting positions that protect and allow them to fire into their assigned sectors.
- c. **Protection:** Fighting positions **protect** Soldiers by providing cover through sturdy construction and by providing concealment through positioning and proper camouflage.

- d. The enemy must not be able to identify the position until it is too late, and he has been effectively engaged.
- e. When possible, Soldiers should site positions in non-obvious places, behind natural cover, and in an easy to camouflage location.
- f. The most important step in preparing a fighting position is to make sure that it cannot be seen.
- g. In constructing fighting positions, Soldiers should always:
  - (1) Dig the positions armpit deep.
  - (2) Fill sandbags about 75 percent full.
  - (3) Revet excavations in sandy soil.
  - (4) Check stabilization of wall bases.
  - (5) Inspect and test the position daily, after heavy rain, and after receiving direct or indirect fires.
  - (6) Maintain, repair, and improve positions as required.
  - (7) Use proper materiel correctly.
- h. Sighting to engage the enemy.
  - (1) Soldiers must be able to engage the enemy within their assigned sectors of fire.
  - (2) They should be able to fire out to the maximum effective range of their weapons with maximum grazing fire and minimal dead space.
  - (3) Soldiers and leaders must be able to identify the best location for their positions that meet this criteria.
  - (4) Leaders must also ensure that fighting positions provide interlocking fires.
  - (5) This allows them to cover the platoon's sector from multiple positions and provides a basis for final protective fires.
- i. Prepare by Stages.
  - (1) Leaders must ensure that their Soldiers understand when and how to prepare fighting positions based on the situation.
  - (2) Soldiers normally prepare hasty fighting positions every time the platoon halts (except for short security halts)—half the platoon digs in while the other half maintains security.
  - (3) Soldiers prepare positions in stages that require a leader to inspect the position before moving on to the next stage.
- j. **Stage 1** - The leader checks the fields of fire from the prone position and has the Soldier emplace sector stakes (see figure 8-10).



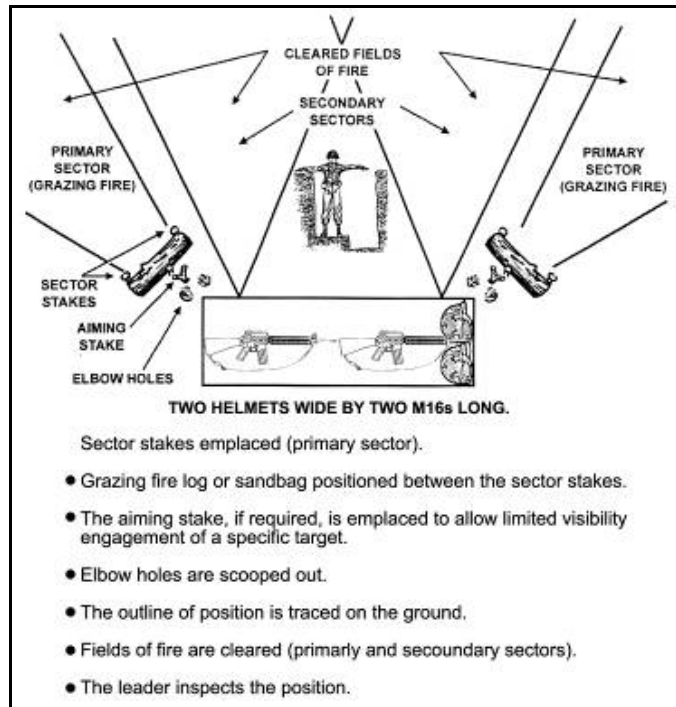

**Figure 8-10. Stage 1 - Fighting position preparation**

k. **Stage 2** - The retaining walls for the parapets are prepared and there is at least one helmet distance from the edge of the hole to the beginning of the front, flank, and rear cover (see figure 8-11).

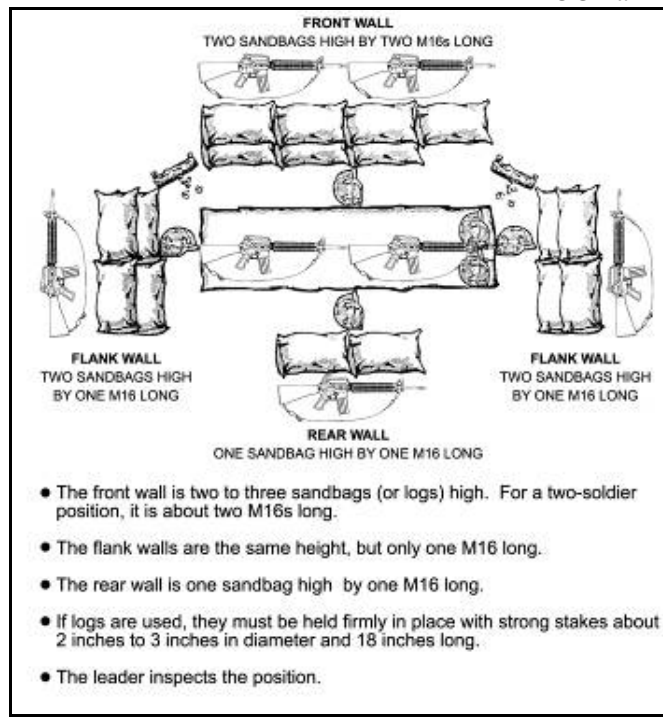

**Figure 8-11. Stage 2 - Fighting position preparation**

1. **Stage 3** - The position is dug, and the dirt is thrown forward of the parapet retaining walls where it is packed down hard (see figure 8-12).

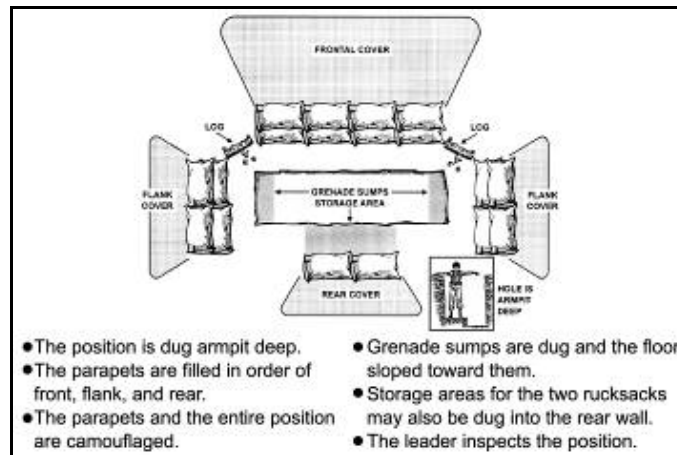

**Figure 8-12. Stage 3 - Fighting position preparation**

m. **Stage 4** - The overhead cover is prepared (see figure 8-13) and camouflage blends with surrounding terrain so the position is not detectable at a distance of 35 meters.

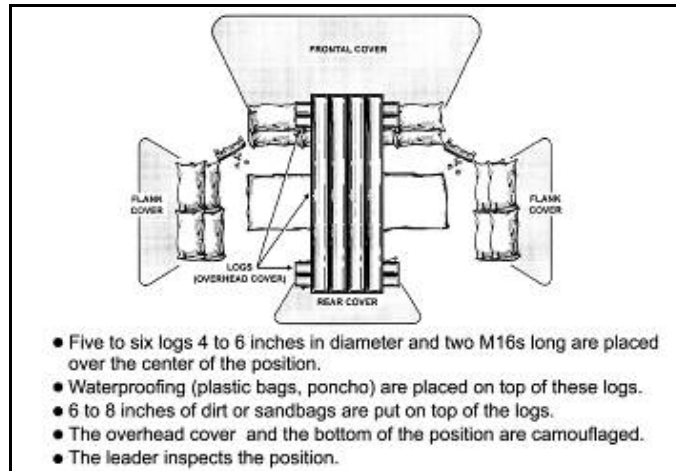

**Figure 8-13. Stage 4 - Fighting position preparation**

n **Types of Fighting Positions:** The number of personnel, types of weapons, time available, and terrain are the main factors that dictate the type of fighting position.

(1) **Hasty fighting position.**

- (a) Soldiers prepare this type of position when there is little or no time to prepare fighting positions (see figure 8-14).
- (b) They locate it behind whatever cover is available.
- (c) It should give frontal protection from direct fire while allowing fire to the front and oblique.
- (d) A hasty position may consist simply of a rucksack placed beside a tree or large rock.
- (e) For protection from indirect fire, a hasty fighting position should be in a small depression or hole at least 18 inches deep.
- (f) The term hasty position does not mean there is no digging.
- (g) Even if there are only a few minutes, a prone shelter can be scraped out or dug to provide some protection.
- (h) This type of position is suited for ambushes or for protection of overwatching elements during raids and attacks.
- (i) Hasty positions can also be the first step in construction of more elaborate positions.



**Figure 8-14. Hasty fighting position**

- (2) **One-Soldier fighting position.**
- (a) This type of position allows choices in the use of cover.
  - (b) The hole only needs to be large enough for one Soldier and his gear.
  - (c) It does not have the security of a two-Soldier position.
  - (d) The one-Soldier fighting position must allow a Soldier to fire to the front or to the oblique from behind frontal cover (see figure 8-15).



**Figure 8-15. One-Soldier fighting position**

- (3) **Two-Soldier fighting position.**
- (a) A two-Soldier fighting position can be prepared in close terrain.
  - (b) It can be used where grazing fire and mutual support extend no farther than to an adjacent position.

- (c) It can be used to cover dead space just in front of the position.
- (d) One or both ends of the hole are extended around the sides of the frontal cover.
- (e) Changing a hole this way lets both Soldiers see better and have greater sectors of fire to the front.
- (f) Also, during rest or eating periods, one Soldier can watch the entire sector while the other sleeps or eats.
- (g) If they receive fire from their front, they can move back to gain the protection of the frontal cover.
- (h) By moving about 1 meter, the Soldiers can continue to find and hit targets to the front during lulls in enemy fire.
- (i) This type of position requires more digging and is harder to camouflage.
- (j) It is also a better target for enemy hand grenades (see figure 8-16).



**Figure 8-16. Two-Soldier fighting position**

#### **8-6. Cover, concealment, and camouflage**

a. If the enemy can see you, he can hit you with his fire. So you must be concealed from enemy observation and have **cover** from enemy fire. When the terrain does not provide natural cover and **concealment**, you must prepare your cover and use natural and man-made materials to **camouflage** yourself, your equipment, and your position.

b. **Cover** gives protection from bullets, fragments of exploding rounds, flame, nuclear effects, and biological and chemical agents (see figure 8-17).

- (1) Cover can also conceal you from enemy observation.
- (2) Cover can be natural or man-made.
- (3) Natural cover includes such things as logs, trees, stumps, ravines, and hollows.
- (4) Manmade cover includes such things as fighting positions, trenches, walls, rubble, and craters.

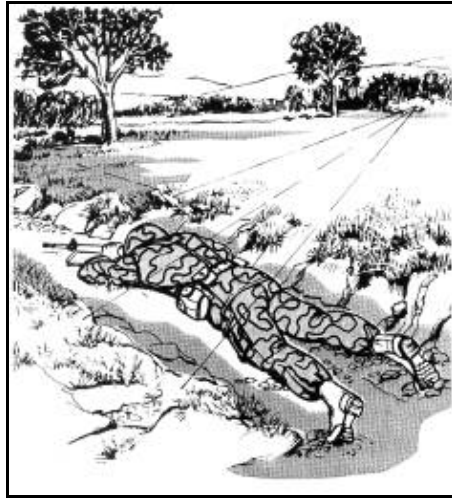

**Figure 8-17. Types of cover**

(5) Even the smallest depression or fold in the ground can give some cover.

(6) Look for and use every bit of cover the terrain offers.

(7) In combat, you need protection from enemy direct and indirect fire.

(8) To get this protection in the defense, build a fighting position (man-made cover) to add to the natural cover afforded by the terrain.

(9) To get protection from enemy fire in the offense or when moving, use routes that put cover between you and the places where the enemy is known or thought to be.

(10) Use ravines (see figure 8-18), gullies, hills, wooded areas, walls, and other cover to keep the enemy from seeing and firing at you.

(11) Avoid open areas and do not skyline yourself on hilltops and ridges.



**Figure 8-18. Troops moving along a ravine**

- c. **Concealment** is anything that hides you from enemy observation.
- (1) Concealment does not protect you from enemy fire.
  - (2) Do not think that you are protected from the enemy's fire just because you are concealed.
  - (3) Concealment, like cover, can also be natural or man-made.
  - (4) Natural concealment includes such things as bushes, grass, trees, and shadows.
  - (5) If possible, natural concealment should not be disturbed.
  - (6) Man-made concealment includes such things as battle-dress uniforms, camouflage nets, face paint, and natural material that has been moved from its original location.
  - (7) Man-made concealment must blend into the natural concealment provided by the terrain.
  - (8) Light discipline, noise discipline, movement discipline, and the use of camouflage contribute to concealment.
  - (9) Light discipline is controlling the use of lights at night by such things as not smoking in the open, not walking around with a flashlight on, and not using vehicle headlights.
  - (10) Noise discipline is taking action to deflect sounds generated by your unit (such as operating equipment) away from the enemy, and when possible, using methods to communicate that do not generate sounds (arm-and-hand signals).
  - (11) Movement discipline restricts movement around fighting positions (unless necessary) and around routes that lack cover and concealment.
  - (12) In the defense, build a well-camouflaged fighting position and avoid moving about. In the offense, conceal yourself and your equipment with camouflage and move in woods or on terrain that gives concealment.
  - (13) Darkness cannot hide you from enemy observation in either offense or defense.
  - (14) The enemy's night vision devices and other detection means let them find you in both daylight and darkness.
- d. **Camouflage** is anything you use to keep yourself, your equipment, and your position from looking like what they are.
- (1) Both natural and man-made material can be used for camouflage.
  - (2) Change and improve your camouflage often.
  - (3) The time between changes and improvements depends on the weather and on the material used.
  - (4) Over time, natural camouflage can lose its effectiveness (die, fade).
  - (5) Likewise, man-made camouflage may wear off or fade.
  - (6) When those things happen, you and your equipment or position may not blend with the surroundings.
  - (7) That may make it easy for the enemy to spot you.

**(8) Camouflage considerations.**

(a) **Movement draws attention** when you give arm-and-hand signals or walk about your position, your movement can be seen by the naked eye at long ranges. In the defense, stay low and move only when necessary. In the offense, move only on covered and concealed routes.

(b) **Positions** must not be where the enemy expects to find them. Build positions on the side of a hill, away from road junctions or lone buildings, and in covered and concealed places. Avoid open areas.

(c) **Outlines and shadows** may reveal your position or equipment to air or ground observers. Outlines and shadows can be broken up with camouflage. When moving, stay in the shadows when possible.

(d) **Shine** may also attract the enemy's attention. In the dark, it may be a light such as a burning cigarette or flashlight. In daylight, it can be reflected light from polished surfaces such as shiny mess gear, a worn helmet, a windshield, a watch crystal and band, or exposed skin. A light or its reflection may help the enemy detect your position. To reduce shine, cover your skin with clothing and face paint. Also, dull the surfaces of equipment and vehicles with paint, mud, or some type of camouflage material.

**NOTE:** In a nuclear attack, darkly painted skin can absorb more thermal energy and may burn more readily than bare skin.

(e) **Shape** is outline or form. The shape of a helmet is easily recognized. A human body is also easily recognized. Use camouflage and concealment to breakup shapes and blend them with their surroundings. Be careful not to overdo it.

(f) **Colors of your skin, uniform, and equipment** may help the enemy detect you if the colors contrast with the background.

- For example, a green uniform will contrast with snow-covered terrain.

- Camouflage yourself and your equipment to blend with the surroundings.

(g) **Dispersion** is the spreading of men, vehicles, and equipment over a wide area (see figure 8-19).

- It is usually easier for the enemy to detect Soldiers when they are bunched. So, spread out.

- The distance between you and your fellow Soldier will vary with the terrain, degree of visibility, and enemy situation.

- Distances will normally be set by unit leaders or by a unit's standing operating procedure (SOP).





**Figure 8-19. Fire team dispersed**

- (h) How to camouflage.
- Before camouflaging, study the terrain and vegetation of the area in which you are operating.
    - Then pick and use the camouflage material that best blends with that area.
    - When moving from one area to another, change camouflage as needed to blend with the surroundings.
    - Take grass, leaves, brush, and other material from your location and apply it to your uniform and equipment and put face paint on your skin (see figure 8-20).



**Figure 8-20. Camouflaged Soldiers**

- (2) **Fighting positions:** When building a fighting position, camouflage it and the dirt taken from it (see figure 8-21).
  - Camouflage the dirt used as frontal, flank, rear, and overhead cover.
  - Camouflage the bottom of the hole to prevent detection from the air.
  - If necessary, take excess dirt away from the position (to the rear).
  - Do not over camouflage.
  - Too much camouflage material may actually disclose a position.
  - Get your camouflage material from a wide area.
  - An area stripped of all or most of its vegetation may draw attention.
  - Do not wait until the position is complete to camouflage it.
  - Camouflage the position as you build.



**Figure 8-21. Camouflaged fighting position being improved**

- Do not leave shiny or light-colored objects lying about. Hide mess kits, mirrors, food containers, and white underwear and towels.
- Do not remove your shirt in the open. Your skin may shine and be seen.
- Never use fires where there is a chance that the flame will be seen or the smoke will be smelled by the enemy.
- Cover up tracks and other signs of movement.
- When camouflage is complete, inspect the position from the enemy's side. This should be done from about 35 meters forward of the position.
- Check the camouflage periodically to see that it stays natural looking and conceals the position.
- When the camouflage becomes ineffective, change and improve it (see figure 8-21).
- **Helmets:** Camouflage your helmet with the issue helmet cover or make a cover of cloth or burlap that is colored to blend with the terrain.
  - The cover should fit loosely with the flaps folded under the helmet or left hanging.

## TRADOC Pam 600-4

- The hanging flaps may break up the helmet outline.
- Leaves, grass, or sticks can also be attached to the cover.
- Use camouflage bands, strings, burlap strips, or rubber bands to hold those in place.
- If there is no material for a helmet cover, disguise and dull helmet surface with irregular patterns of paint or mud.
- **Uniforms:** Most uniforms come already camouflaged.
- However, it may be necessary to add more camouflage to make the uniform blend better with the surroundings.
- To do this, put mud on the uniform or attach leaves, grass, or small branches to it.
- Too much camouflage, however, may draw attention.
- When operating on snow-covered ground, wear over-whites (if issued) to help blend with the snow. If over-whites are not issued, use white cloth, such as white bed sheets to get the same effect.
- **Skin:** Exposed skin reflects light and may draw the enemy's attention.
- Even very dark skin, because of its natural oil, will reflect light.
- Use figure 8-22 and table 8-4 for guidance when applying face paint to camouflage the skin.
- 



**Figure 8-22. Colors used in camouflage**

- When applying camouflage work with a buddy (in pairs) and help each other.
- Apply a two-color combination of camouflage stick in an irregular pattern.
- Paint shiny areas (forehead, cheekbones, nose, ears, and chin) with a dark color.
- Paint shadow areas (around the eyes, under the nose, and under the chin) with a light color.
- In addition to the face, paint the exposed skin on the back of the neck, arms, and hands.
- Palms of hands are not normally camouflaged if arm-and-hand signals are to be used.
- Remove all jewelry to further reduce shine or reflection.

- o When camouflage sticks are not issued, use burnt cork, bark, charcoal, lamp black, or light-colored mud.

**Table 8-4**  
**Camouflaging skin**

	<b>Skin Color</b>	<b>Shine Areas</b>	<b>Shadow Areas</b>
<b>Camouflaged Material</b>	Light or dark	Forehead, cheekbones, ears, nose, and chin	Around eyes, under nose, and under chin
<b>Loam and Light Green Stick</b>	Use in areas with green vegetation	Use loam	Use light green
<b>Sand and Light Green Stick</b>	Use in areas lacking green vegetation	Use light green	Use sand
<b>Loam and White</b>	Use only in snow-covered terrain	Use loam	Use white
<b>Burnt Cork, Bark Charcoal, or Lamp Black</b>	Use if camouflage sticks not available	Use	Do not use
<b>Light-colored Mud</b>	Use if camouflage sticks not available	Do not use	Use

**8-7. Chemical, biological, radiological, nuclear, (CBRN) - standard mission oriented protective posture (MOPP)**

- a. See FM 3-11.4, Multiservice Tactics, Techniques, and Procedures for Nuclear, Biological, and Chemical Protection.
- b. All Soldiers need to be familiar with standard MOPP levels (see figure 8-23).
- c. The system is flexible, and subordinate leaders can modify their unit MOPP level to meet mission needs.
- d. Standardized MOPP levels allow commanders to increase or decrease levels of protection through the use of readily understood prowords.

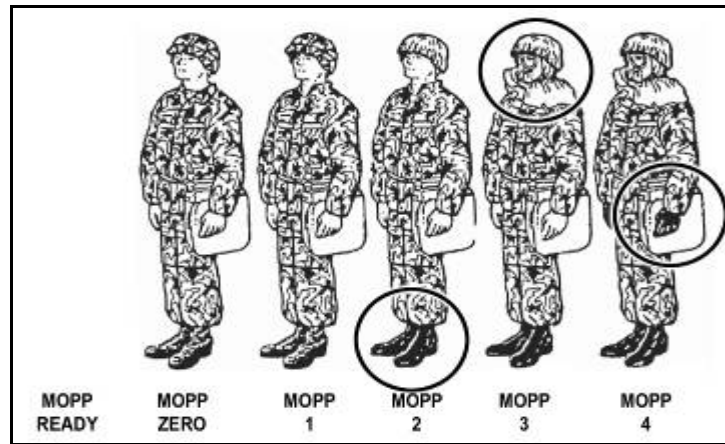

**Figure 8-23. Standardized MOPP levels**

e. Commanders determine which protective posture their subordinate units will assume (see figure 8-23), and then direct their units to assume that MOPP level (see table 8-5). The following standardized protective postures assume that personnel are carrying their individual decontamination kit, M8/M9 detector paper, NAAK, and protective masks.

(1) **MOPP Ready:** Personnel carry their protective masks with their load carrying equipment.

(a) Individual MOPP gear is labeled and stored no farther back than a logistics site (brigade support area) and is ready to be brought forward to the individual when needed.

(b) Pushing MOPP gear forward should not exceed 2 hours.

(c) Units in MOPP ready are highly vulnerable to persistent agent attacks and will automatically upgrade to MOPP 0 when they determine or are notified that CBRN weapons have been used or that the threat exists for CBRN weapons use.

(e) When a unit is at MOPP ready, personnel will have field-expedient items, such as wet weather gear, identified for use in the event of an unanticipated CBRN attack.

(2) **MOPP zero:** Soldiers carry their protective masks with their load carrying equipment.

(a) The standard battle dress over garment and other IPE making up the Soldier's MOPP gear are readily available.

(b) To be considered readily available, equipment must be either carried by each Soldier or stored within arms reach (within work area, vehicle, or fighting position).

(c) Units in MOPP zero are highly vulnerable to persistent agent attacks and will automatically upgrade to MOPP1 when they determine, or are notified, that persistent chemical weapons have been used or that the threat for use of chemical weapons has risen.

- (3) **MOPP:** When directed to MOPP1, Soldiers immediately don the battle dress over garment.
  - (a) In hot weather, the over garment jacket can be unbuttoned, and the battle dress over garment can be worn directly over underwear.
  - (b) M9 or M8 chemical detection paper is attached to the over garment.
  - (c) **MOPP1** provides a great deal of protection against persistent agent.
  - (d) This level is automatically assumed when chemical weapons have been employed in an area of operations or when directed by higher commands.

**Table 8-5  
Availability and wear of MOPP equipment**

<b>MOPP Level</b>	<b>Description</b>
<b>MOPP Ready</b>	Carry mask and ensure that IPE is nearby*
<b>MOPP 0</b>	Carry mask and ensure that IPE is available**
<b>MOPP 1</b>	Don over garments
<b>MOPP 2</b>	Add protective boots
<b>MOPP 3</b>	Add protective mask
<b>MOPP 4</b>	Add protective gloves
* IPE must be available to Soldiers within 2 hours. A second set must be available in 6 hours.	
** IPE must be within arm's reach of personnel.	

- (4) **MOPP2:** Soldiers put on their chemical protective footwear covers (CPFCs), GVOS, or a field expedient item (for example, vapor-barrier boots) and the protective helmet cover is worn.
  - (a) As with MOPP1, the over garment jacket may be left unbuttoned.
  - (b) Trousers remain closed.
- (5) **MOPP3:** Soldiers wear the protective mask and hood.
  - (a) Flexibility is built into the system to allow Soldiers relief at MOPP3.
  - (b) Particularly in hot weather, Soldiers can open the over garment jacket and roll the protective mask hood for ventilation.
  - (c) Trousers remain closed.
- (6) **MOPP4:** Soldiers will completely encapsulate themselves by closing their over garments, rolling down and adjusting the mask hood, and putting on the CBRN rubber gloves with cotton liners.
 

**NOTE:** MOPP4 provides the highest degree of chemical protection.
- (7) **MOPP options:** A MOPP option includes mask only. The mask is worn with the long-sleeve duty uniform (for limited skin protection). The mask-only command may be given in these situations:
  - (a) When riot control agents are being employed and no CB threat exists.

- (b) In a downwind vapor hazard of a non-persistent CB agent.

**CAUTION**  
“Mask only” is not normally an appropriate command when blister or nerve agents are involved

(8) Automatic masking: Automatic masking is the act of immediately masking and assuming MOPP4 when encountering CB attack indicators.

(a) Before CB weapons usage is confirmed, personnel will don their mask when there is a high probability of a CB attack.

(b) When chemical agents have been employed, commanders at all levels may establish a masking criteria in their Operations Order and/or SOP.

(c) Once this information is disseminated, personnel will mask and assume MOPP4 automatically whenever one of these events occurs.

(d) Automatic masking criteria should be used by the commander as a decision tool and is based on CBRN intelligence, risk assessment, and METT-T.

(e) Subordinate commanders may upgrade the MOPP levels and add automatic masking criteria at their discretion.

(f) High probability CB attack indicators can include the following and must be reacted to by automatic masking:

- Sound of chemical-agent alarm or vocal alarm.
- A positive reading on chemical-agent detector paper or a CAM.
- Personnel experiencing symptoms of chemical-agent poisoning.
- Seeing others in mask or MOPP 3 or 4.
- Unknown smoke.
- Dead animals and birds.
- Unknown liquid coming from the air or laying on the ground on a non-rainy day.
- Bombs or shells popping, not exploding as most bomb/artillery rounds would.

### 8-8. Tactical foot marches and foot care

a. **Tactical marches** transport troops from one place to another by any available means.

(1) This is inherent in all military operations.

(2) A successful move places troops and equipment at their destination at the proper time ready for combat.

(3) Troop movement is conducted by foot or motor marches on rail, air, water, or through various combinations of these methods.

b. There are many **historic examples** of famous, successful foot marches.

(1) The grueling foot march that took place during the Sicilian campaign from 20 to 21 July 1943 is a good example of a successful World War II foot march.

(a) The 3d Battalion, 30th Infantry Regiment, 3d Infantry Division performed this march.

(b) The battalion was directed to move on foot across mountains from Aragona to San Stefano to enter into a coordinated attack on enemy forces in San Stefano.

(c) The battalion made this record-breaking, 54-mile, cross-country continuous march in only 33 hours.

(d) Two hours after arrival, the battalion was committed in the attack on San Stefano, which resulted in its capture.

(2) A second example was the movement of large elements of the 3rd U.S. Army during the battle of Ardennes in 1944 to stop the enemy counteroffensive.

(a) On 16 December 1944, while the 3d U.S. Army was preparing to attack the Siegfried line in Germany, the Battle of the Bulge commenced.

(b) By 19 December, the German attack had reached such large proportions that the 3d U.S. Army was directed to cease its attack to the east and turn north.

(c) The 3rd U.S. Army shifted its troops from the Saarlautern - Saarbrücken area to the Luxembourg-Belgium area, a distance of 100-road miles.

(d) The III Corps launched the new attack at 0600 on 22 December 1944.

c. **Considerations for conducting a foot march.**

(1) **March discipline** includes observing and enforcing the rules and instructions that govern a unit on a march.

(a) These include formation, distances between elements, speed, and the effective use of concealment and cover.

(b) Specific controls and restrictions such as water, light, noise, and disciplines are also included.

(c) March discipline is the culmination of effective training, which results in enthusiastic teamwork among all Soldiers of the unit.

(2) **Water discipline** must be observed by all unit members to ensure best health and marching efficiency. The following rules must be adhered to:

(a) Drink plenty of water before each march to aid sustainment during movement.

(b) Drink only treated water from approved sources.

(c) Drink water often—before, during, and after the march.

(d) Drink small quantities of water rather than gulping or rapid intake.

(e) Drink water even when not thirsty.

(f) Drink water slowly to prevent cramps or nausea.

(g) Avoid spilling water.



TRADOC Pam 600-4

(h) Refill canteens at every opportunity.

(i) The human body does not operate efficiently without adequate liquid intake.

- When Soldiers are engaged in strenuous activities, excessive amounts of water and electrolytes are lost through perspiration.
- More water is lost through normal body functions such as respiration and urination, which can create a liquid imbalance in the body.
- Dehydration can occur under both above conditions unless water is immediately replaced and Soldiers rest before continuing activities.
- Deficient liquid and salt intake during hot weather can also result in heat injuries.
- The danger of dehydration is as prevalent in cold regions as it is in hot, dry areas.
- The difference is that in hot weather the Soldier is aware that his body loses liquids and salt through perspiration.
- When a Soldier is bundled up in many layers of clothing during cold weather, he can't see perspiration and has difficulty knowing this condition exists. Any perspiration is rapidly absorbed by heavy clothing or evaporates and is rarely visible on the skin.
- Salt in food compensates for the daily salt requirement.
- Additional intake of salt should be under the direction and supervision of a physician or physician's assistant.
- If pure water is not available, water in canteens can be treated by adding water purification tablets. (See FM 21-10, *Field Hygiene and Sanitation* for methods of purifying water.)
- If the unit is forced to traverse a CBRN contaminated area due to the tactical situation, water consumption increases and forced hydration becomes necessary.
- Leaders at all levels must try to prevent heat injuries brought on by physical activity in an CBRN environment.

(3) **Foot care** during a march is extremely important since feet are enclosed in heavy rigid footwear during most working hours and are constantly in action.

(a) Good hygiene measures include bathing frequently, using foot powder, wearing properly fitted footwear to allow for ventilation, and correctly trimming toenails.

(b) The care of minor foot ailments caused by the march should be given the utmost attention.

(c) Many major conditions requiring hospitalization and disability have resulted from neglected or maltreated minor conditions.

(d) Conditioning is accomplished by progressively increasing the distance to be marched from day to day.

- Marching is a good way to strengthen the feet and legs.
- Running alone will not suffice.

- The arch, ankle, and calf can be conditioned by performing simple exercises such as rising high on the toes, or standing on a towel and using the toes to roll the towel back under the arch.
- Certain preventive measures can be implemented to avoid painful foot problems.
  - Before marches, trim toenails at least every two or three weeks, depending upon individual needs.
  - Cut toenails short and square, and straight across (See chapter 4, Personal Hygiene for added details).
  - Keep feet clean and dry, and use foot powder.
  - Wear clean, dry, un-mended, good-fitting socks (preferably cushion-soled) with seams and knots outside.
  - A nylon or polypropylene sock liner can reduce friction and add protection.
  - Carry an extra pair of socks.
  - Carefully fit new boots.
  - When getting used to a new pair of boots, alternate with another pair; tape vulnerable foot areas before wearing.
  - During halts, lie down with the feet elevated.
  - If time permits, massage the feet, apply foot powder, change socks, and medicate blisters.
  - Cover open blisters, cuts, or abrasions with absorbent adhesive bandages.
  - Obtain relief from swelling feet by slightly loosening bootlaces where they cross the arch of the foot.
  - After marches, repeat procedures for the care of feet, wash and dry socks, and dry boots.
  - Medicate blisters, abrasions, corns, and calluses.
  - Inspect painful feet for sprains and improper fitting of socks and boots.
  - Feet can develop red, swollen, tender skin along the sides of the feet from prolonged marching, which could become blisters.
  - Therefore, feet require aeration, elevation, rest, and wider footwear.
  - Prevent major foot problems by keeping the feet clean.
  - The formation of blisters and abrasions with dirt and perspiration can cause infection and serious injury.
  - If possible, give the feet a daily foot bath.
  - In the field, cool water seems to reduce the sensation of heat and irritation.
  - After washing, dry the feet well.
- (4) The most common **foot injuries** that occur from foot marches include:
  - (a) **Blisters and abrasions** are caused by improperly conditioned feet, ill-fitting footwear and socks, improperly maintained footwear, heat, and moisture.
    - They are normally caused by friction or pressure, as opposed to impact.

#### TRADOC Pam 600-4

- To clean a blister, wash gently around it with soap and water, being careful not to break the skin.
  - Cover the blister with an absorbent adhesive bandage or similar dressing, extending beyond the edge of the blister.
  - After applying the dressing, dust the outside of the dressing and entire foot with foot powder.
  - Use just enough foot powder since it can harden and become irritating.
  - Foot powder lessens friction on the skin and prevents the raw edges of the adhesive plaster from adhering to socks.
  - The adhesive plaster should be smooth so it can serve as a "second skin."
  - Carefully inspect the foot for other problem areas that are red and tender that may need the protection of an adhesive plaster.
  - Cover abrasions and cuts on the foot with absorbent adhesive bandages for rapid healing.
  - In an emergency, medical personnel can inject tincture of benzoin into a blister to prevent further abrasion and loss of skin.
- (b) **Foot perspiration** decomposes skin and causes a foul odor.
- The skin between the toes usually becomes white and soft, rubs off easily, and is prone to abrasions.
  - Treatment consists of washing and thoroughly drying the feet, and applying foot powder to the skin, especially between the toes and inside the sock.
- (c) **Athlete's foot** usually occurs between the toes, on the sole of the foot, and at points of contact between skin and footwear.
- Mild cases of athlete's foot can be treated by applying foot powder daily.
  - If fungicidal cream is available, it can be used directly on affected spots before applying foot powder to the rest of the affected foot.
  - If applications of foot powder and cream do not heal the infection, an aidman or surgeon should be consulted.
- (d) **Frostbite** is the freezing of a body part due to exposure to below-freezing temperatures (See Chapter 4, Field Sanitation and Preventive Medicine Fieldcraft for more details).
- **Prevent frostbite** by wearing enough clothing for protection against cold and wind.
  - The face must be protected during high winds and when exposed to aircraft propeller blast.
  - Clothing and the body must be kept dry.
  - To avoid perspiring when performing heavy work in the cold, Soldiers should remove outer layers of clothing and then replace them when work is finished.
  - Socks should be changed when the feet become moist.
  - Cold metal should not be touched with the bare skin in extremely low temperatures—to do so could mean loss of skin.

- Adequate clothing and shelter must be provided during inactive times.
- The face, fingers, toes, and ears should be exercised or massaged to keep them warm and to detect any numb or hard areas.
- The buddy system should always be used—Soldiers should find partners and observe each other for signs of frostbite and for mutual aid if frostbite occurs.
- Any small frozen spots should be thawed immediately, using bare hands or other sources of body heat.
- Some cases of frostbite may be superficial, involving only the skin.
- If freezing extends below the skin, it demands more involved treatment to avoid or lessen the loss of the body part (fingers, toes, hands, or feet).
- Often there is no pain, so Soldiers must observe each other for signs.
- Since it is difficult to distinguish between superficial and deep frostbite, a Soldier should assume the injury to be deep and therefore serious.
- If numbness has been for a short time, the frostbite is probably superficial.
- For further discussion of frostbite and its treatment, see chapter 4, Field Sanitation and Preventive Medicine Fieldcraft.

(e) **Immersion foot and trench foot** are thermal injuries that result from severe cold-weather exposure (32\* to 50\* F) in damp or wet environments. See Chapter 4, Field Sanitation and Preventive Medicine Fieldcraft for further details.

- Attributing causes include immobility of the limbs as in sitting or standing, insufficient clothing, and constriction of body parts due to boots, socks, and other garments.
- Trenchfoot is similar to gradual frostbite since the primary causes are the same. The only difference is in the degree of cold.
- In the early stages of trenchfoot, feet and toes are pale, cold, numb, and stiff.
  - Walking becomes labored.
  - If preventive action is not taken at this stage, the feet will swell and become painful.
  - In extreme cases of trenchfoot, the flesh dies and amputation of the foot or leg may be needed.
  - Because the early stages of trenchfoot are not painful, Soldiers must be alert to prevent it.
  - For further discussion of immersion foot and trench foot, including treatment, see Chapter 4, Field Sanitation and Preventive Medicine Fieldcraft.

(f) **Stress fractures and muscle injuries** need time to heal.

- The affected area must rest for 2 or 3 weeks until the pain is gone, followed by a slow return to activity to avoid recurring injury.

TRADOC Pam 600-4

- Personnel who have had an injury are more likely to be injured again.
  - The best form of treatment for this type injury is prevention.
    - This can be accomplished through a conditioning program.
    - Ensure major muscle groups are properly stretched and warmed up before marching.
- (5) **Care for boots** by drying after use to avoid losing shape and hardening of the leather.
  - (a) This can be done by placing a warm cloth in the boot or by any method that avoids rapid drying.
  - (b) To prevent moist leather from freezing during winter, boots should be placed inside a sleeping bag or used as a headrest.
- (6) **Properly fitted boots** are ensured by checking that the space between the end of the great toe and the toe of the boot is the width of the thumb.
  - (a) In the unlaced boot, there should be enough space under the lower edge of the tongue to insert an index finger.
  - (b) Poorly fitted boots can cause blisters, abrasions, calluses, and corns.
  - (c) Pressure is caused by boots being too small.
  - (d) Friction is caused by boots being too large.
  - (e) If the tops of the toes are involved, the cap is too low or too stiff.
  - (f) If the ends of the toes are affected, the boot is too short or too loosely laced.
  - (g) If the sides of the big and little toes become irritated, the boot is too narrow.
  - (h) Irritation at the heel is caused by boots being too long, too loosely laced, or too wide a heel space.
- (7) **Properly laced boots** prevent blisters and improper blood flow in the foot.
  - (a) Laces can assume a seesaw action, which can produce a long blister across the instep.
  - (b) To prevent blistering, avoid lacing over the instep.
  - (c). If possible, broad laces should be used and an extra pair should be carried.
- (8) Check for **properly fitted socks** by first standing with your weight evenly distributed on both feet.
  - (a) If the socks fit correctly, no tightness or fullness should exist.
  - (b) The wool cushion-sole sock is best because it offers good foot protection.
  - (c) Soldiers should allow 3/8 of an inch for shrinkage of new socks.
  - (d) Those that are too large wrinkle inside the shoe, rub the feet, and cause blisters and abrasions.
  - (e) Socks that are too small wear quickly and reduce blood flow in the foot.
  - (f) Wear two pairs of socks when breaking in new boots—dress socks underneath wool socks.

- (g) Socks must be changed daily - dirty socks are conductors of heat that allow warmth to escape.
- (h) Socks should be washed in lukewarm water to preserve the fiber—hot water can cause them to shrink.
- (i) When socks become damp, they can be dried by placing them inside a shirt next to the body.
- (j) Socks should be completely dry before wearing.
- (k) If it is not possible to wash the socks, they should be changed.
- (l) Dirty socks should be dried and kneaded with the hands to remove dirt and hardness.

### 8-9. Key to defeating an improvised explosive device (IED)

See table 8-6 for the key to defeating an IED.

Table 8-6

#### Key to defeating an IED

**VEHICLE DISPERSION:** 75 meters (m) to 100 m or greater makes it more difficult to target the convoy correctly (this separation results in late or early detonation and the likelihood that the enemy will not get away).

**LET THEM KNOW THAT YOU ARE READY:** The enemy is looking for an easy mark; he wants to get away. Show him that you are not an easy target.

**KNOW THE INDICATORS** (bags, piles of rocks, piles of dirt in or beside the road). If you don't like what you see, trust your instinct, stop, turn around, and go another way. Report observation through the chain of command. Let the experts check it out.

**VARY THE ROUTE AND TIME AND SPEED OF TRAVEL:** We know the enemy is watching us and attempting to determine our patterns. Make every attempt to vary this pattern; never take the same route twice in two days. The enemy placed the IED there for a reason, and he is targeting you!

**ALWAYS HAVE FRONT AND REAR SECURITY OUT:** Roll up or remove HMMWV/FMTV canvas, so that you can see behind you, and pay attention to where you are going. Determine who has what security responsibilities before you move, face out during movement, and constantly scan assigned sectors of fire. Many ambushes are initiated with an RPG shot from the rear.

**REPORT, SECURE, AND REDUCE CACHE SITES:** The enemy is drawing his supply of explosives from somewhere. Leave the reduction of a site to EOD. Mark and report.

**TRAVEL IN CONVOYS OF 3 OR MORE VEHICLES:** The enemy may not detonate the IED if he believes that he will be caught. It is very difficult to successfully attack 3 or more vehicles if they are widely dispersed.

**8-10. Key to identifying an IED**

See table 8-7 for identifying an IED.

**Table 8-7****Identifying an IED**

**IEDS can be disguised to look like any object and to function through a multitude of actions. An IED is only limited by the bomber's imagination and capabilities. IEDs are unpredictable and extremely hazardous to all, including the bomber. Be aware of dual IEDs.**

**1. Devices are camouflaged with bags of various types to resemble garbage along the roadways or devices are buried in the roadbed.**

**2. Decoy devices are emplaced in the open to slow or stop convoys in the kill zone of the actual device that is obscured along the route of travel.**

**3. Devices are thrown or fired from overpasses or from the roadside in front of approaching vehicles or in the middle of convoys. These devices are usually grenades or rocket propelled grenades.**

**4. Devices are concealed in potholes in the road (covered with dirt) and previous IED locations along main supply routes and alternate supply routes (targeting convoys) and along unimproved roads (targeting patrols).**

**5. Vehicle-borne IEDs are used to gain access and detonate in close proximity to compounds/buildings. They are also often used against patrols and logistic sites.**

**6. Suicide attacker (suicide vests) (possibly employed by women), are used in close proximity to coalition forces.**

**THIS PAGE LEFT BLANK INTENTIONALLY**



### **9-1. Principles of CRM and accident prevention**

#### a. Background.

(1) You are American Soldiers. You are the Army's most precious resource; the sons and daughters of our nation. Without you, the Army cannot fulfill its reason for existing, which is to fight and win the nation's wars. Remember the Soldier's Creed. You stand ready to deploy, engage, and destroy the enemies of the United States of America in close combat. Doing so may cost your life, or the life of your buddies. Freedom is not free. This is serious business, and the Army takes very seriously its responsibility to make sure that no one loses their life needlessly. Soldiering is tough, demanding, and risky. This means we take risks and don't shrink from responsibility. The Army trains, equips, and organizes its Soldiers to ensure victory, but each Soldier, regardless of rank, is faced with making decisions. You will be challenged to make smart decisions about risk, decisions that will affect not only yourself, but also your team, family, and friends. Composite Risk Management does not apply just in combat. It applies to everything you do, on duty or off duty. Anything that may take a Soldier out of the fight is a risk that must be managed, whether by a sniper's bullet or a poor decision to drink and drive. This is about preserving the Army's ability to fight. Composite Risk Management will help you make smart risk decisions and reduce the possibility of becoming a loss. It may save your life or the lives of your buddies.

(2) CRM is the Army's decisionmaking process for identifying and assessing hazards, developing and implementing risk mitigation actions to control risk across the full spectrum of Army missions, functions, operations, and activities. CRM is a decisionmaking process used to identify and eliminate or reduce risks associated with all hazards that have the potential to injure or kill personnel, damage or destroy equipment, or otherwise impact mission effectiveness. CRM addresses both tactical and accident risks. The primary premise of CRM is that it does not matter where or how a loss occurs, the result is the same - decreased combat power or mission effectiveness. FM 5-19 is the Army's doctrinal manual for risk management.

(3) Accidents continue to take a toll on Soldiers supporting Offensive, Defensive, Stability, and Civil Support Operations. Soldiers must therefore be prepared to apply the composite risk management process during all types of missions to reduce accident potential.

#### b. Composite Risk Management Process.

(1) CRM is the process of identifying, assessing, and controlling hazards to protect the force.

(2) The five steps of CRM represent a logical and systematic thought process users can apply to analyze any event or situation. When applied correctly, CRM can identify and control those hazards

and risks that might threaten success. The steps are covered in sub point 3.

(3) The CRM process is continuous and applicable to any situation or environment, on or off duty. Figure 9-1 illustrates the CRM process.

(4) There are five principles to guide to CRM:

(a) Apply CRM to every mission and activity, both on and off duty. This means combat missions and weekend tailgate parties.

(b) Make risk decisions at the right level. If you cannot control the risks, elevate the decision up the chain of command. Off duty, if you're not comfortable with the risk, do the same thing.

(c) Accept no unnecessary risk. Do not disable or kill yourself doing something needless and stupid. Except in dire circumstances, charging an enemy bunker with no helmet, no weapon, and no plan, is probably a foolish move. Perhaps there is a way to control the hazards and reduce the risk. What about riding a motorcycle without a helmet, or choosing to drink and drive? Are there unnecessary risks involved?

(d) Apply CRM cyclically and continuously. The last step of the process reveals how effectively CRM has been applied. As the mission or activity progresses, CRM is applied continuously to identify and control new or residual hazards.

(e) Do not be risk averse. In some cases, charging the bunker without enough ammo may be necessary to prevent worse things from happening. We may have to risk our lives so that others might live. Soldiering is the business of danger, and we must be as smart about things as we can, but when it comes down to it, we go back to the Soldier's Creed: We will always place the mission first; we will never accept defeat; we will never quit.

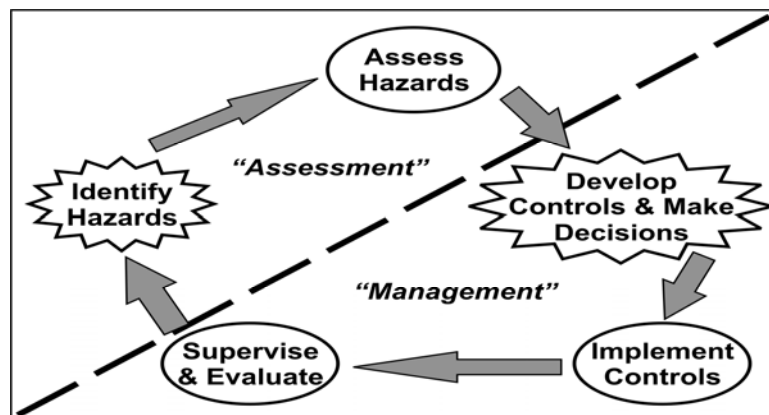

Figure 9-1. CRM process

c. The Five Steps of Composite Risk Management.

(1) Identify *Hazards*. Step one in the composite risk management process is to identify hazards. A hazard is any condition with the

potential to cause injury, illness, or death of personnel, damage to or loss of equipment or property, or mission degradation. A hazard may also be a situation or event that can result in degradation of capabilities or mission failure. Hazards exist in all environments—combat operations, stability operations, base support operations, training, garrison activities, and off-duty activities. The factors of mission, enemy, terrain and weather, troops and support available, time available, and civil considerations (METT-TC) serve as a standard format for identification of hazards, on or off duty.

(2) Assess *Hazards*. Step two is to assess the hazards to determine their cumulative effect on the planned activity. Hazards are assessed and risk is assigned in terms of probability and severity of adverse impact of an event or occurrence. This step considers the risk or likelihood of an event or incident adversely influencing mission capabilities, people, equipment, or property. The hazard assessment process asks these questions: “What are the odds (probability) of something going wrong, and what is the effect (severity) of the incident if it does occur?” Exercising judgment on how to eliminate or reduce hazards to lessen the overall risk is inherent in the risk assessment process. This step concludes with a risk assessment that describes the impact of all combined hazards. The result of the assessment produces an initial risk estimate for each identified hazard expressed in terms of EXTREMELY HIGH, HIGH, MODERATE, or LOW as determined from the standardized application of the risk assessment matrix (see figure 9-2).

RISK ASSESSMENT MATRIX						
		Probability				
Severity		Frequent A	Likely B	Occasional C	Seldom D	Unlikely E
Catastrophic	I	E	E	H	H	M
Critical	II	E	H	H	M	L
Marginal	III	H	M	M	L	L
Negligible	IV	M	L	L	L	L
E – Extremely High		H – High		M – Moderate		L – Low

**Figure 9-2. Risk assessment matrix**

(a) **Hazard assessment measures.** Assess each hazard on the probability of the event or occurrence. Probability is the likelihood of an event. This is your estimate, given what information you know and what others have experienced. The probability levels estimated for each hazard are based on the mission, course of action (COA), or

frequency of a similar event. For the purpose of CRM, there are five levels of probability - frequent, likely, occasional, and seldom.

- **Frequent** – occurs very often, known to happen regularly. In illustration, given 500 or so exposures to the hazard, expect that it will definitely happen to someone. Examples of frequent occurrences are vehicle rollovers, rear end collisions, and heat injury during a battalion physical training run with hot weather or non-acclimated Soldiers.

- **Likely** – Occurs several times, a common occurrence. Given 1000 exposures, without proper controls, assessment determines a potential hazard of this nature will occur at some point. Examples include IED, wire strikes for aircraft, controlled flight into terrain, and negligent discharges.

- **Occasional** – Occurs sporadically, but is not uncommon. Soldiers may or may not get through deployment without it happening.

Examples include unexploded ordinance (UXO), and fratricide.

- **Seldom** – Remotely possible, could occur at some time. Usually several things must go wrong for it to happen. Examples could include heat-related death or electrocution.

- **Unlikely** – Can assume will not occur, but not impossible.

Examples might include detonation of containerized ammunition during transport.

**(b) Estimate the expected result or severity of an occurrence.**

Severity is expressed in terms of the degree to which an incident will influence combat power, mission capability, or readiness. The degree of severity estimated for each hazard is based on knowledge of the results in similar past events. It is addressed in the following four levels used on the risk assessment worksheet:

- **Catastrophic** –

- Complete mission failure or the loss of ability to accomplish a mission.
- Death or permanent total disability.
- Loss of major or mission-critical systems or equipment.
- Major property or facility damage.
- Severe environmental damage.
- Mission-critical security failure.
- Unacceptable collateral damage.

- **Critical** –

- Severely degraded mission capability or unit readiness.
- Permanent partial disability or temporary total disability exceeding three months time.
- Extensive major damage to equipment or systems.
- Significant damage to property or the environment.
- Security failure.
- Significant collateral damage.

- **Marginal** –

- Degraded mission capability or unit readiness.

#### TRADOC Pam 600-4

- Minor damage to equipment or systems, property, or the environment.
- Lost days due to injury or illness not exceeding three months.
- Minor damage to property or the environment.
- Negligible –
  - Little or no adverse impact on mission capability
  - First aid or minor medical treatment
  - Slight equipment or system damage, but fully functional or serviceable.
- Little or no property or environmental damage

(c) **Determine Level of Risk.** Using the standard risk assessment matrix, probability and severity for each identified hazard are converted into a specified level of risk. This matrix provides an assessment of probability and severity expressed in terms of a standard level of risk. The assessment is an estimate, not an absolute. It may or may not be indicative of the relative danger of a given operation, activity, or event. The levels of risk are listed in the lower left corner of the matrix. All accepted residual risk must be approved at the appropriate level of command.

- **Extremely High Risk**– Loss of ability to accomplish the mission. Rating implies that the risk associated with a mission, activity, or event may have severe consequences beyond those associated with a specific operation or event. The decision to continue must be weighed carefully against the potential gain to be achieved by continuing a COA.

- **High Risk** – Significant degradation of mission capabilities in terms of the required mission standard, inability to accomplish all parts of the mission, or inability to complete the mission to standard if hazards occur during the mission. This implies that if a hazardous event occurs, serious consequences will occur. The decision to continue must be weighed carefully against the potential gain to be achieved by continuing this COA.

- **Moderate Risk** – Expected degraded mission capabilities in terms of the required standard will have a reduced mission capability if hazards occur during the mission. If a hazardous event occurs it will only slightly impact the mission, result in only minor injury or loss, and will not affect overall readiness.

- **Low Risk** – Expected losses have little or no impact on accomplishing the mission. Injury, damage, or illness are not expected, or may be minor and have no long-term impact or effect.

(3) Develop *Controls and Make Risk Decisions*. Step three is to develop controls and make a risk decision. In step 2, hazards were assessed and an initial risk level was determined. In this step, control measures are developed and applied. The hazard is reassessed to determine a residual risk. Risk decisions are always based on the residual risk. The process of developing and applying controls and reassessing risk continues until an acceptable level of risk is achieved or until all risks are reduced to a level where benefits outweigh

potential cost. The overall mission or activity risk level is determined by the single highest residual risk. Considered individually, the residual risk associated with each hazard may be low, but considered collectively, sound judgment may dictate elevating the overall risk level above that of any single residual risk. Leaders must weigh the risk against the benefits of performing an operation. Unnecessary risk can endanger mission accomplishment and subject Soldiers to unnecessary risk of accidents and injuries. Risk decisions are made at a level that corresponds to the degree of risk. For example, extremely high-risk acceptance or denial decisions are made by a general officer; high-risk decisions by brigade commander or first O6; moderate risk decisions by battalion commander or first O5; and low risk decisions by a company commander or leader at the execution level. The commander may elect to have some decisions made at lower levels of management.

(a) Implement *Controls*. Step four is to implement the controls established as a result of steps one through three. Included in this step is leader action to reduce or eliminate hazards. Controls may be implemented substantially through the writing of an SOP or condensed in a short safety briefing.

(b) Supervise & *Evaluate*. Step five of the CRM process is the means by which we ensure that risk controls are implemented and enforced to standard. This step also provides the means of validating the adequacy of selected control measures in supporting objectives and desired outcomes. Like other steps of the CRM process, supervision and evaluation must occur throughout all phases of any operation or activity. This continuous process provides the ability to identify weaknesses and make changes or adjustments to controls based on performance, changing situations, conditions, or events. Supervision in this sense goes beyond ensuring that people do what is expected of them. Evaluation includes constant monitoring during an operation and following up as part of after action reviews to ensure that all went according to plan. Supervision and evaluation during and after an operation aids in making adjustments to accommodate unforeseen issues and incorporating lessons learned for future use.

## **9-2. CRM tracking and documentation**

When time and situation allow, the Army standard CRM worksheet (DA Form 7566, *Composite Risk Management Worksheet*) or an electronic version is used to document the CRM process. In addition to providing an Army standard, continuous use of this worksheet reinforces CRM application and trains leaders, Soldiers, and individuals to think in terms of a five-step CRM process. Instructions for completing DA Form 7566 are available in FM 5-19 and in GTA - 21-08-001, *Composite Risk Management Quick Reference Booklet*.

**9-3. CRM and the individual Soldier**

a. The Soldier's primary role in CRM is to support commanders and leaders by identifying and reporting hazards. In addition, Soldiers must reduce or eliminate hazards within their ability and authority. For example, telling another Soldier to put on their seatbelt, or fasten the chinstrap of their helmet, is taking a simple step to reduce or eliminate the hazards. In many cases, Soldiers face much more demanding situations where Soldier and teams are forced to act alone, and make tough risk decisions. Practicing CRM every day will help prepare them for the difficult risk decisions.

b. CRM on and off-duty:

(1) CRM is a "life skill" that does not stop at the end of the duty day, but carries over to off duty activities.

(2) Be your "Brothers Keeper." Use the buddy system during all missions and activities, on and off duty. Live by the Warrior Ethos, Soldier's Creed, and Army Values.

(3) Apply CRM to YOUR daily operations to identify areas of high-risk and implement controls to reduce the risks.

(4) Know your enemy. Know your equipment. Know your environment.

(5) Follow tactics, techniques, and procedures. Do not compromise the standard.

**THIS PAGE LEFT BLANK INTENTIONALLY.**



TRADOC Pam 600-4

**Appendix A**

**References**

**Section I**

**Required Publications**

This section contains no entries.

**Section II**

**Referenced Publications**

5 CFR Part 2635

Standards of Ethical Conduct for Employees of the Executive Branch

Army Regulation 600-63

Army Health Promotion

Army Regulation 601-280

Army Retention Program

Army Regulation 604-10

Personnel Security Checks

DOD 5500.7-R

Joint Ethics Regulation

FM 3-11.4

Multiservice Tactics, Techniques, and Procedures for Nuclear,  
Biological, and Chemical Protection

FM 3-21.5

Drill and Ceremonies

FM 5-19

Composite Risk Management

FM 21-10

Field Hygiene and Sanitation

**Section III**

**Prescribed Forms**

This section contains no entries.

**Section VI**

**Referenced Forms**

DA Form 2028

Recommended Changes to Publications and Blank Forms

DA Form 7279-R  
Equal Opportunity Complaint Form

DA Form 7566  
Composite Risk Management Worksheet



**SOLDIER'S NOTES**



**SOLDIER'S NOTES**



**SOLDIER'S NOTES**





**SOLDIER'S NOTES**



**SOLDIER'S NOTES**



**SOLDIER'S NOTES**



**SOLDIER'S NOTES**





**SOLDIER'S NOTES**



**SOLDIER'S NOTES**



**SOLDIER'S NOTES**

**Glossary**

Section I  
Abbreviations

ACU	Army combat uniform
AFTB	Army family team building
AIT	advanced individual training
ARNG	Army National Guard
ASAP	Army Substance Abuse Program
AT	antitank
BAH	basic allowance for housing
BCT	basic combat training
COA	course of action
CPT	captain
COL	colonel
CSM	command sergeant major
DA	Department of the Army
DEET	N-diethyl-m-toluamide
DIMHRS	Defense Integrated Military Human Resources System
DOD	Department of Defense
E1-2	private
E3	private first class
EO	equal opportunity
FM	field manual
IED	improvised explosive device
IET	initial entry training
LES	leave and earning statement
LTC	lieutenant colonel
METT-TC	mission, enemy, terrain and weather, troops and support available, time available, and civil Considerations
MOS	military occupational specialty
MOPP	mission oriented protective posture
MSG	master sergeant
MWPA	military whistleblower protection act
NCO	noncommissioned officer
OSUT	one station unit training
PAC	personnel administration center
PSG	platoon sergeant
RC	U.S. Army Reserve Components
SFC	sergeant first class
SGLI	Serviceman's Group Life Insurance
SGM	sergeant major
SOP	standard operating procedure
SPC	specialist
SSG	staff sergeant

TRADOC	U.S. Army Training and Doctrine Command
UCMJ	Uniform Code of Military Justice
U.S.	United States
USAR	U.S. Army Reserve
WO1 through5	warrant officer one through five
1SG	first sergeant
1LT	first lieutenant
2LT	second lieutenant



